

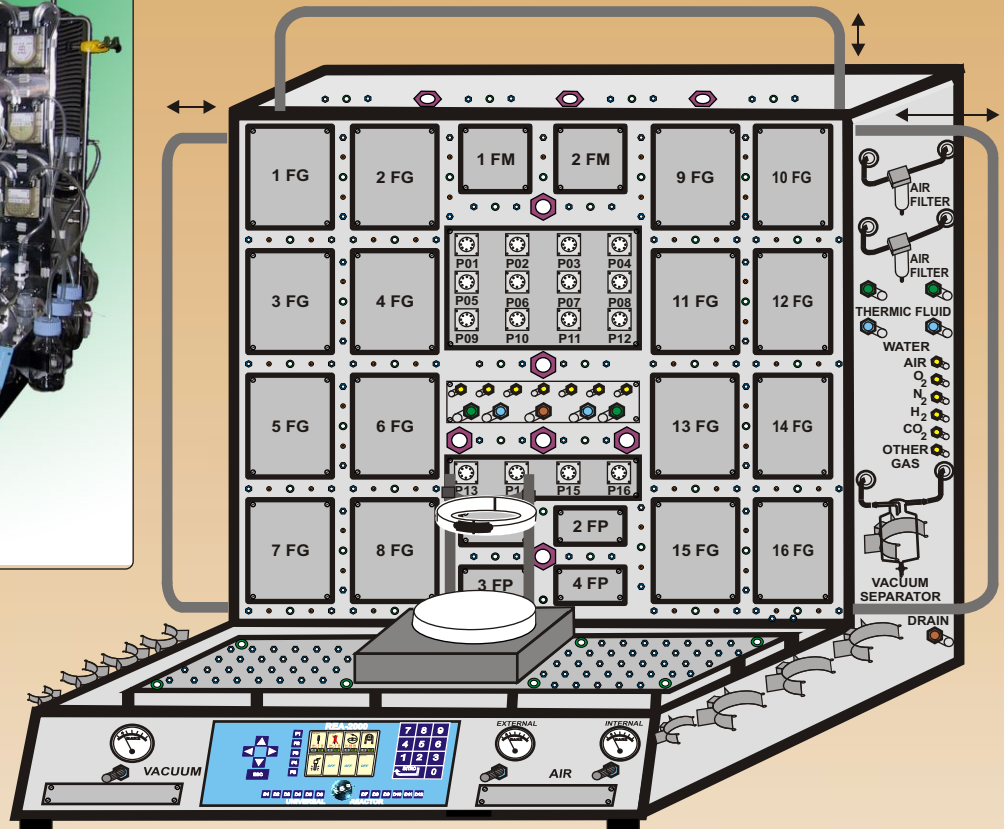

MINI-LAB

REA-2000

BASIC UNIT

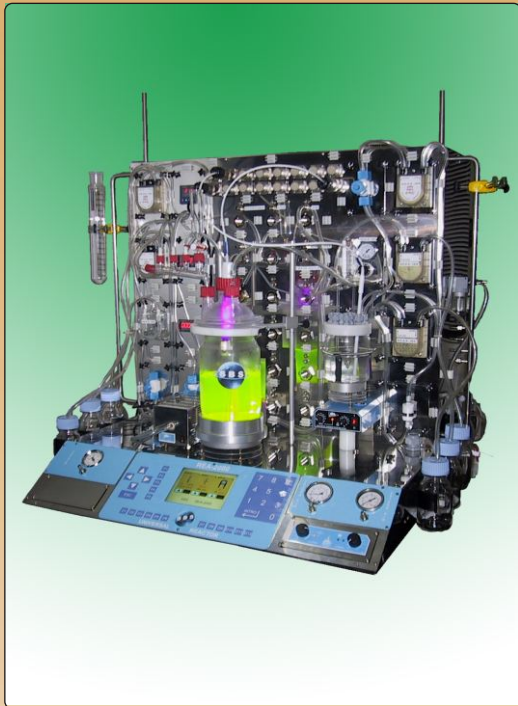

Modular reactor completely configurable by the own user. There is available a very big quantity of accessories to do many combinations to allow to realize the maximum of chemical processes & reactions in the following main fields: ANAEROBIC DIGESTIONS-BIOCHEMISTRY-BIOGENESIS-BIOSYNTHESIS-BIOTECHNOLOGY-BOTANIC-CALORIMETRY-CELLS-CULTURE-DIGESTIONS-DISTILLATION-TITRATIONS-EDUCATION-ELECTROCORROSION-ELECTROLYSIS-FERMENTATION-FLOCCULATION-PHOTOCHEMISTRY-PHOTOSYNTHESIS-RECTIFYNG-REFLUX-SOXHLET-TISSUES CULTURE-TITRATIONS-SLUGDES TREATMENT

Réacteur modulaire de 2 litres complètement configurable par le même utilisateur, muni avec un grand numéro d'accessoires pour permettre faire beaucoup de combinaisons et pouvoir réaliser toute sorte de process ou reactions dans: BIOCHIMIE-BIOGENESE-BIOSYNTHÈSE-BIOTECHNOLOGIE-BOTANIQUE-CALORIMETRIE-CULTURE DES CELLULES-CULTURE DES TISSUES-DISTILLATIONS-DIGESTIONS ANAEROBIQUES-EDUCATION-ELECTROCORROSION-ELECTROLYSE-FERMENTATION-PHOTOCHIMIE-PHOTOSYNTHESE-FLOCCULATION-REFLUXE-RECTIFICATION-SOXHLET-TITRATIONS-TRAITEMENTS DES BOUES

Reactor modular totalmente configurável, pelo utilizador. Estão disponíveis um grande número de acessórios que permitem fazer muitas combinações e efectuar qualquer processo ou reacção nos seguintes campos da química: BIOQUÍMICA-BIOGÉNESE-BIOSÍNTESE-BIOTECNOLOGIA-BOTÂNICA-CALORIMETRIA-CULTURA DE CÉLULAS-CULTURA DE TECIDOS-DESTILAÇÕES-DIGESTÕES-DIGESTÕES ANAERÓBICAS-EDUCAÇÃO-ELECTROCORROÇÃO-ELECTRÓLISE-FERMENTAÇÃO-FLOCCULAÇÃO-FOTOQUÍMICA-FOTOSÍNTESE-REFLUXO-RECTIFICAÇÃO-SOXHLET-TITRAÇÕES-TRATAMENTOS DE LODOS

Reactor modular totalmente configurable por los propios usuarios, con un gran número de accesorios combinables entre sí, para poder efectuar toda clase de reacciones, procesos y ensayos en áreas de la química tales como: BIOQUÍMICA-BIOGENESIS-BIOSINTESIS-BIOTECHNOLOGIA-BOTANICA-CALORIMETRIA-CULTIVO CELULAR-CULTIVO DE TEJIDOS-DESTILACIONES-DIGESTIONES-DIGESTIONES ANAEROBICAS-EDUCACION-ELECTROCORROSION-ELECTROLISIS-FERMENTACION-FLOCCULADO-FOTOQUÍMICA-FOTOSINTESIS-REFLUJO-RECTIFICACION-SOXHLET-TITRACIONES-DEAD STOP-TRATAMIENTO LODOS

TECDATA																
ISO Class I				DIN 4050 IP33						MWC 60°C 80%H						
REF	Ltr.	mBar	L/min	mmH	L/min	Bar	mmHg	Bar	mmHg	Watt	Rpm/Tpm	°C Max	D	H	W	Kg
REA-2000	2	813	7	610	7	1	800	0.5	650	450	1500	420	755	80	800	





## BASIC UNIT

It is composed by: A stainless steel housing, provided with a few rectangular holes (windows), to allow to insert the modular accessories, fixed by 4 screws. A reactor-cover fixing clamp, with vertical adjustment, to allow to handle the reactor, according to their kind and height. A supporting ring to place round bottom reactors. Clamps to fix 3x250cc 1x50cc reagents flasks, 4 on each side. Several screwed holes and Ø4 female pins, strategically distributed, to allow to insert accessories. 3 telescopic Ø10 bar supports "U" shaped, one on the left, one on the right and the other one on the top, to allow to fix clamps, nuts and accessories. A heating magnetic stirrer. An air compressor with regulation valve, moisture separator filter, and a manometer. A vacuum pump with regulation valve, separation flask and a gauge. 16 inputs for probes and devices, and a USB output port. 20 switches to control 20 accessories. A stainless steel Ø6x200mm PT100 probe. A set of fluids inlets and outlets. A microprocessor "Central Control Unit", with a big screen color plasma, membrane keys to control the speed, temperature, time, and hours counter; provided with 6 cyclical timers. The speed and temperature regulation, can be applied to the magnetic stirrer or to any other stirring and heating devices. Identification system of the plugged accessory displayed on the screen by an icon, the type of device and where same is plugged. All the functions can be effectuated by manually, by a microprocessor IR control of 50 steps, or through a PC (Accessories).

## ACCESSORIES

All the following accessories described, unless otherwise indicated, are made of borosilicate glass, PTFE, or stainless steel. The responsibility of the accessories combination between them selves, is only on the **technical user**, who must bear in mind the limitations, incompatibilities or ability for each kind of test, assembly or reaction as for the technical specifications of each material.



## UNITEE BASIQUE

Boîtier en acier inox avec fenêtres pour placer des éléments modulaires qui sont fixés moyen 4 vis. Muni avec un support réacteur, mobile verticalement pour ajuster l'hauteur du réacteur; un anneau support pour réacteurs à fond rond; pinces latéraux dans chaque coté pour flacons réactifs 3x250cc 1x50cc; plusieurs trous visés et pins femelle Ø4 distribués estrategiquement, pour fixer accessoires; 3 supports telescopiques avec forme d "U" en tige Ø10 inox, l'un placé à gauche, autre à droite, et l'autre en haut. Avec un agitateur magnétique chauffant avec régulation de vitesse et de température numériques, une pompe à vide avec régulateur, vacuomètre, et séparateur à l'aspiration; un compresseur d'air avec régulateur, manomètre, et filtre séparateur d'air; une Pt100 Ø6x200mm en inox; 16 prises pour brancher sondes et accessoires, une sortie USB pour piloter par PC, 20 interrupteurs pour pouvoir contrôler 20 accessoires, embouts d'entrées et de sorties pour fluides et une unité de contrôle central équipée avec: Une grande écran à couleur, clavière à membrane pour la régulation de la vitesse, température, temps et compteur d'heures, et 6 temporisateurs cycliques. Munie avec un système d'identification de l'accessoire branché et où, moyen un icone dans l'écran. Toutes les fonctions peuvent se effectuer de façon manuelle, par microprocesseur à 50 etapes à tele-contrôl IR, ou pilotées par PC.

## ACCESSOIRES

Les accessoires décrits dans les suivantes pages, sauf indication contraire, sont faits en verre borosilicate, PTFE, acier inox. La responsabilité de la combinaison entre eux, c'est uniquement du **Téchnique Usuaire**, qui doit avoir en consideration les limitations, incompatibilités et ideoneitée, pour chaque essai, ensemble et réaction, d'acord avec les spécifications de chaque matériel



## UNIDADE BÁSICA

Chassi em aço inox provido de orifícios quadrados para colocar os diferentes elementos modulares os quais se fixam com 4 parafusos. Grampo fixador reactor-tampa móvel na vertical para manusear e ajustar a altura do reactor. Aro suporte para reactores de fundo redondo. Clips em cada lado para fixar frascos de reagentes 3x250cc, 1x50cc. Orifícios roscados e pins fêmea Ø4, situados estrategicamente para fixar acessórios. 3 suportes telescópicos barra Ø10 com forma de "U" situados a direita, esquerda, por cima. Bomba de vácuo-regulador-vacuómetro-frasco separador; compressor de ar-regulador-manómetro filtro separador; agitador magnético aquecedor com regulação da temperatura e velocidade digitais, 1 Pt100 200mm inox, 16 conectores para sondas ou acessórios, uma saída para porta USB, entradas e saídas para fluidos e a **Unidade de Control Central** microprocessada com: Ecrã de cor grande, teclas de membrana para controlar a velocidade, temperatura, tempo e contador de horas; 6 temporizadores cíclicos digitais. A regulação da velocidade e da temperatura pode ser aplicada ao agitador magnético ou aos outros sistemas de agitação e aquecimento. Sistema identificador do acessório ligado, e da porta onde está, com um ícono no ecrã. Todas as funções podem ser manuais, ou através do acessório microprocessador de 50 etapas a control remoto, ou através de um PC.

## ACESSÓRIOS

Os acessórios descritos nas seguintes páginas, excepto quando indicado explicitamente, estão fabricados em vidro borosilicato, PTFE, ou aço inox. A responsabilidade da combinação dos acessórios entre eles, é exclusiva do **técnico utilizador**, que deverá ter em conta as limitações, incompatibilidade e idoneidade para cada ensaio-reacção conforme as especificações de cada material.



## UNIDAD BASICA

Chasis de acero inox dotado de ventanas rectangulares, para colocar los accesorios modulares, que se sujetan con 4 tornillos. Abrazadera de fijación reactor-tapa, desplazable verticalmente para manipular los reactores y ajustar su altura. Anillo soporte para reactores fondo redondo. Clips para fijar en cada lateral frascos de reactivos 3x250cc mas 1x50cc. Taladros roscados M10 /M6 y Pins hembra Ø4 repartidos estrategicamente para fijar soportes y accesorios. 3 soportes telescopicos de varilla Ø10 en forma "U", situados a la izquierda, derecha y arriba . Agitador magnético calefactor con regulación digital de temperatura y velocidad . Compresor de aire con válvula de regulación, manómetro y filtro. Bomba de vacío con válvula de regulación, vacuómetro y trampa de separación. 16 puertos para conectar accesorios y sondas, 1 salida USB, 20 interruptores para controlar 20 accesorios, entradas y salidas para fluidos, una Pt100 inox, y la **Unidad de Control Central** microprocesada: Pantalla de color de gran tamaño, teclado de membrana para controlar las funciones de velocidad, agitación, temperatura, tiempo y contador horario; 6 temporizadores cíclicos. La regulación de la temperatura y de la velocidad se puede aplicar al agitador magnético, o a cualquiera de los otros sistemas de agitación o calefacción. Identificador de accesorio conectado y en que puerto lo ha hecho, con un icono en la pantalla Las funciones se pueden efectuar manualmente, o con accesorios, por microprocesador de 50 pasos telecontrolado, o con un PC.

## ACCESORIOS

Todos los accesorios descritos a continuación, salvo indicación expresa, han sido construidos con vidrio borosilicato, PTFE, o acero inox. La responsabilidad de la combinación de los accesorios entre si, es la del **técnico usuario** que deberá tener en cuenta las limitaciones, incompatibilidades o su idoneidad para cada tipo de ensayo; según las especificaciones de cada material.





HOW & WHERE TO PLACE THE ACCESSORIES

COMME ET OÙ PLACER LES ACCESSOIRES

COMO E ONDE COLOCAR OS ACESSÓRIOS

COMO Y DONDE COLOCAR LOS ACCESORIOS

The modular accessories can be inserted in one of the following devices: Window, M-6 female screw, M-10 female screw, support bars, connectors and Ø4 female pin (In one or few pins with a separation of 40mm). They are placed in all different unit sides. The user decide the accessories situation .

Tous les accessoires modulaires peuvent être fixés dans les suivants dispositifs: Fenêtre, femelle visée M-6, femelle visée M-10, tiges support, connecteurs et pins femelle de Ø4 (Dans un ou plusieurs pins separés 40mm). Ils sont placés dans tous les cotés. L'utilisateur decide l'emplacement.

Todos os acessórios modulares podem fixar-se nos seguintes dispositivos: Ventana, rosca fêmea M-6, rosca fêmea M-10, barras suportes, conectores e pin fêmea Ø4 (Em um ou varios pins separados 40mm). Estan situados em todos os lados. O utilizador devera escolher a sua situação.

Todos los accesorios modulares pueden insertarse en los siguientes dispositivos: Ventana, rosca hembra M-6, rosca hembra M-10, barras soporte, conectores y pins hembra Ø4 (En un o varios pins separados 40mm, en retícula). Están situados en todos los lados. El usuario decide su ubicación.

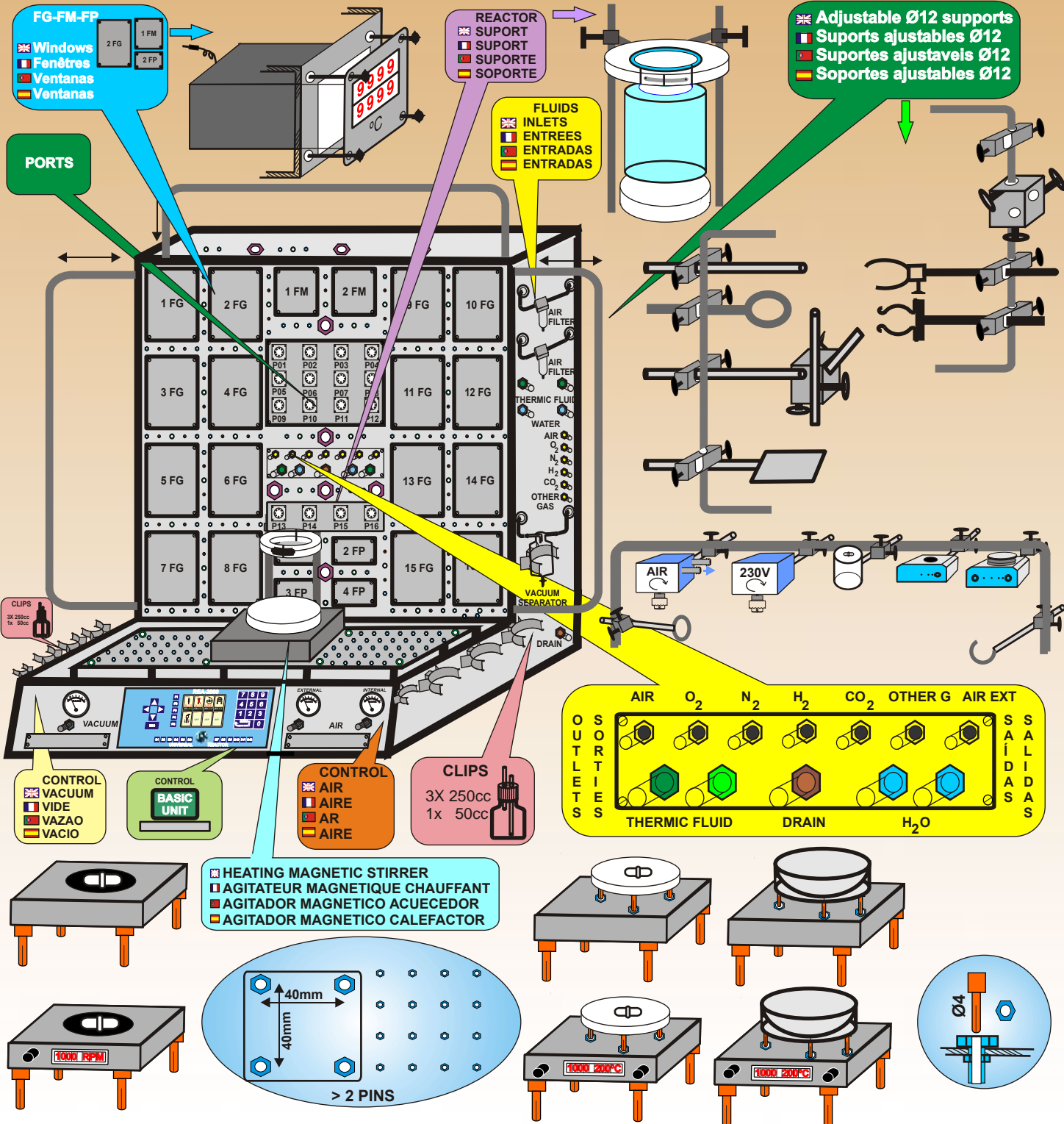





UNIVERSAL REACTOR

REA-2000



REACTOR UNIVERSAL



REACTEUR UNIVERSEL



REACTOR UNIVERSAL

HOW & WHERE TO PLACE THE DEVICES



COMME ET OÙ PLACER LES DISPOSITIFS



COMO E ONDE COLOCAR OS DISPOSITIVOS



COMO Y DONDE COLOCAR LOS DISPOSITIVOS

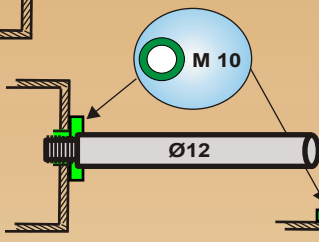
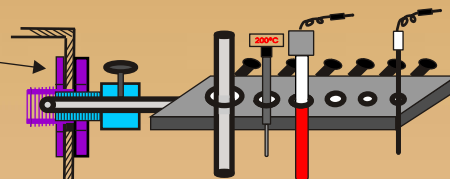
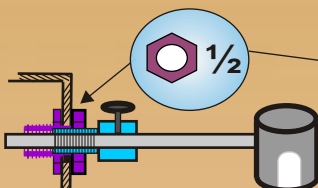
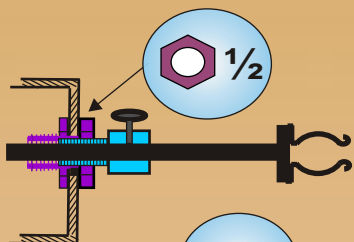

Female screws  
 Femelle visée  
 Tuerca hembra

M6    M10    1/2

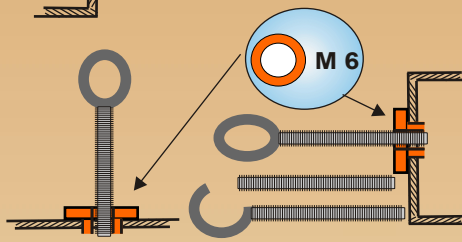

REAX-979

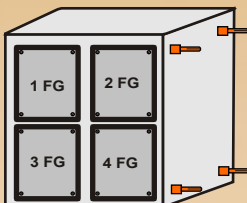

4 AND 6 WINDOWS EXPANDER  
 EXPANSEUR 4 ET 6 FENETRES  
 EXPANSOR DE 4 E 6 VENTANAS  
 EXPANSOR DE 4 Y 6 VENTANAS

REAX-980

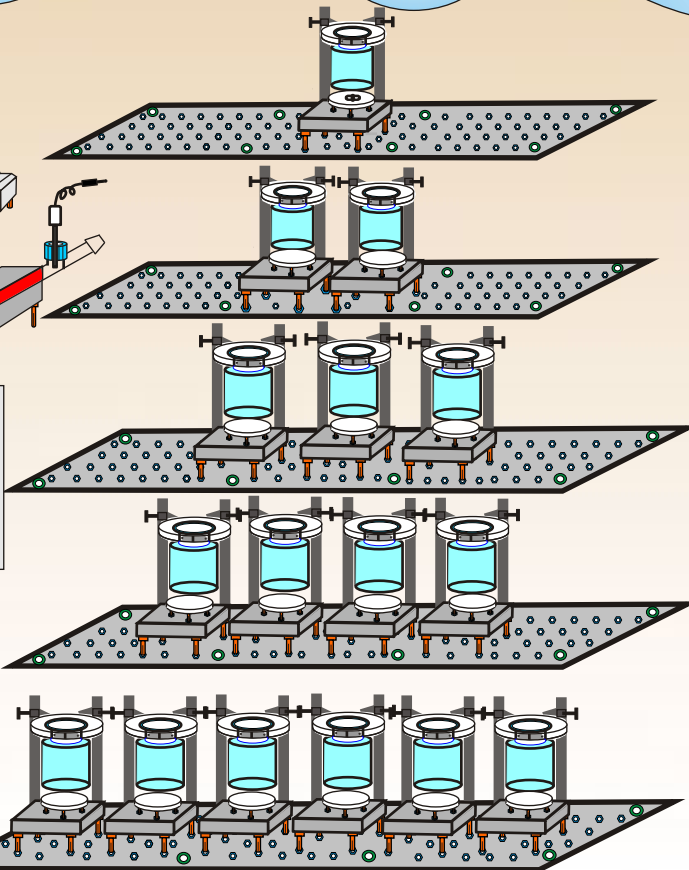
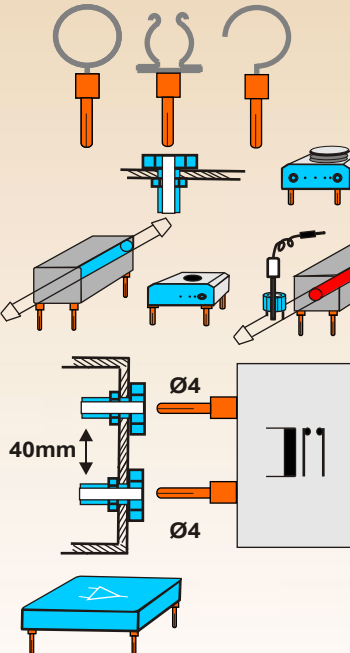
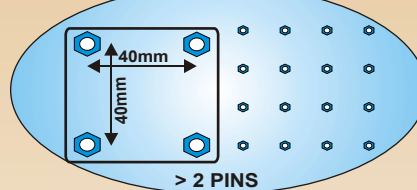
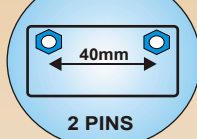
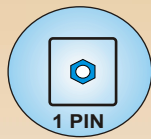
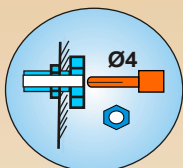
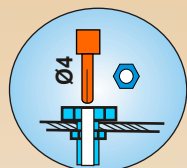
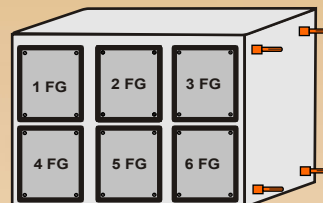

Ø4 Female Pin    Pin femelle Ø4  
 Pin femelle Ø4    Pin hembra Ø4  
 Pin hembra Ø4

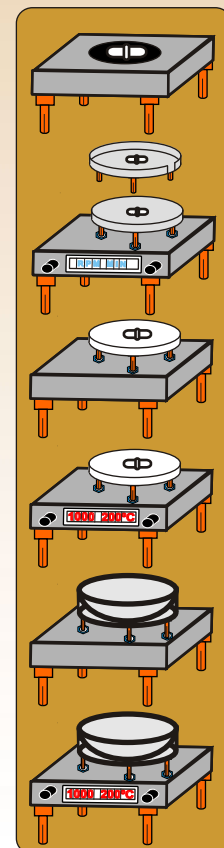

Pag R2a





**2L GLASS REACTORS FLAT BOTTOM**

**REACTORES 2L EM VIDRO FUNDO PLANO**

**REACTEURS EN VERRE 2L FOND PLAIN**

**REACTORES 2L DE VIDRIO FONDO PLANO**

REAX-101: Standard 1L.  
REAX-102: Standard 2L.  
REAX-103: With double jacket.  
REAX-104: Anti-vortex.  
REAX-105: With a lateral neck.

Standard 1L.  
Standard 2L.  
Avec double enveloppe.  
Anti-vortex.  
Avec un col lateral.

Standard 1L.  
Standard 2L.  
Encamisado.  
Anti-vortex.  
Com uma boca lateral.

Standard 1L.  
Standard 2L.  
Encamisado.  
Anti-vortex.  
Con una boca lateral.

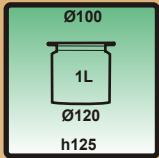

REAX-101

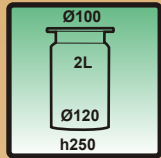

REAX-102

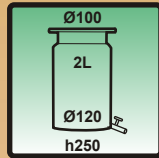

REAX-102/1

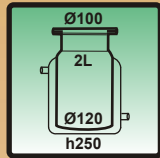

REAX-103

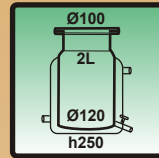

REAX-103/1

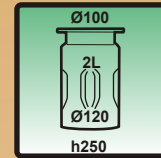

REAX-104

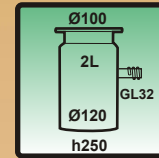

REAX-105

**2L GLASS REACTORS ROUND BOTTOM**

**REACTORES 2L EM VIDRO FUNDO REDONDO**

**REACTEURS EN VERRE 2L FOND ROND**

**REACTORES 2L DE VIDRIO FONDO REDONDO**

REAX-106: Standard round bottom.  
REAX-107: With double jacket.  
REAX-108: With a down valve.  
REAX-109: Jacketed+Down valve.  
REAX-110: Round bottom anti-vortex.  
REAX-111: With a lateral neck.

Standard fond rond.  
Avec double enveloppe.  
Avec robinet inferieur.  
Double enveloppe+Robinet.  
Anti-vortex.  
Avec un col lateral.

Standard fundo redondo.  
Encamisado.  
Com torneira inferior.  
Encamisado+Torneira.  
Anti-vortex.  
Com uma boca lateral.

Standard fundo redondo.  
Encamisado.  
Con llave inferior.  
Encamisado+Llave  
Anti-vortex.  
Con una boca lateral.

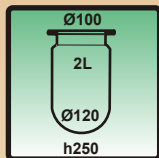

REAX-106

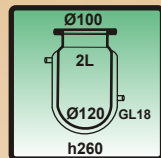

REAX-107

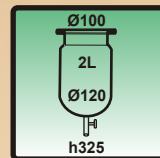

REAX-108

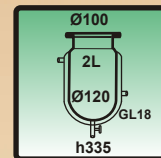

REAX-109

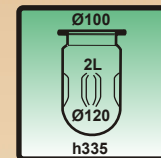

REAX-110

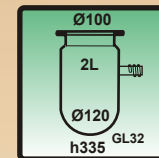

REAX-111

**COVERS**

**COUVERCLES**

**TAMPAS**

**TAPAS**

REAX-112 to REAX-117: Covers made of glass, there are 8 different combinations of standards ISO GL necks available.  
REAX-112 à REAX-117: Couvercles en verre, se fabriquent 8 modèles standard avec combinaisons différentes de cols ISO GL.  
REAX-112 a REAX-117: Fabricadas em vidro, existem 8 modelos standard com combinações de diferentes bocas ISO GL.  
REAX-112 a REAX-117: Tapas fabricadas en vidrio, existen 8 modelos standard con combinaciones de diferentes bocas GL.

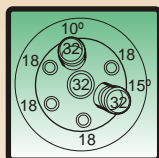

REAX-112



REAX-113

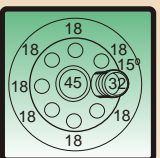

REAX-114

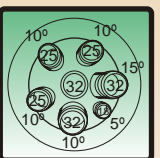

REAX-115

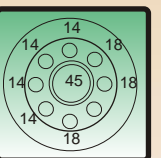

REAX-116

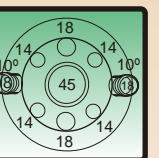

REAX-117

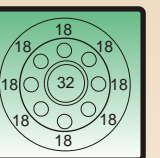

REAX-121

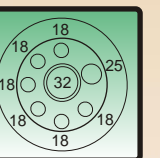

REAX-122

**AUXILIAR MINI REACTORS**

**MINI REACTORES AUXILIARES**

**MINI REACTEURS AUXILIAIRES**

**MINI REACTORES AUXILIARES**

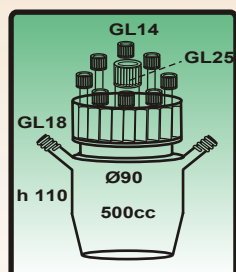

REAX-118

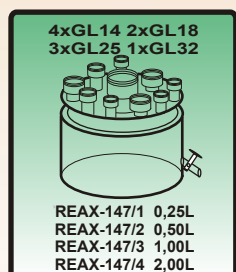

REAX-147/1

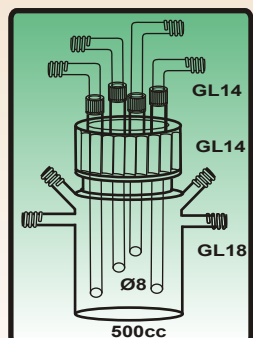

REAX-119

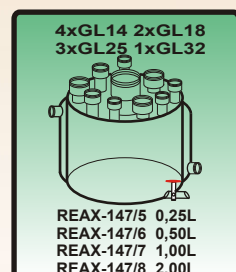

REAX-147/3

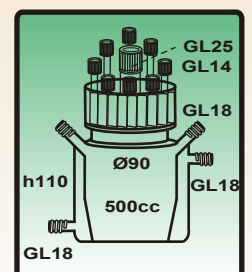

REAX-120

REAX-118: PTFE screwed cap, supplied complete, 9 necks.  
REAX-119: Plastic screwed cap, supplied complete with 4 tubes.  
REAX-120: PTFE screwed cap, supplied complete, double jacket.  
REAX-147: Fermenter reactor. REAX-147/5/6/7/8 Dual jacket

Tampa roscada em PTFE, fornecido completo, 9 bocas.  
Tampa roscada plástico, fornecido completo com 4 tubos.  
Tampa roscada PTFE, fornecido completo, encamisado.  
Reactor Fermentador. REAX-147/5/6/7/8 Encamisado

REAX-118: Bouchon visé en PTFE, livré complet, 9 cols.  
REAX-119: Bouchon visé en plastique, livré complet avec 4 tubes.  
REAX-120: Bouchon visé en PTFE, livré complet, 9 cols.  
REAX-147: Réacteur Fermentateur REAX-147/5/6/7/8 Avec chemise

Tapa roscada de PTFE, suministrado completo, 9 bocas.  
Tapa roscada de plástico, suministrado completo 4 tubos.  
Tapa roscada PTFE, suministrado completo.  
Reactor Fermentador. REAX-147/5/6/7/8 Encamisado





INLET GLASS TUBES | TUBOS D'ENTRÉE EN VERRE | TUBOS DE ENTRADA EN VIDRO | TUBOS DE ENTRADA DE VIDRO

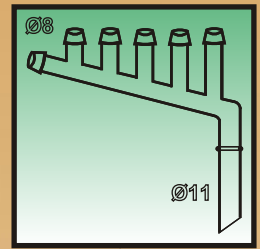
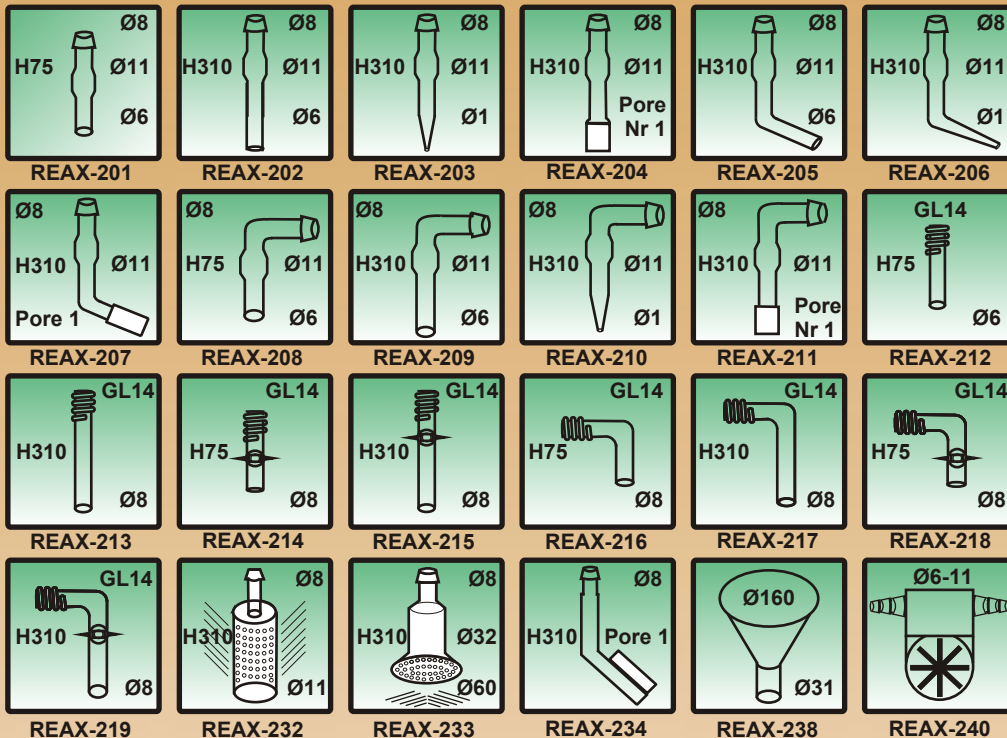

REAX-220

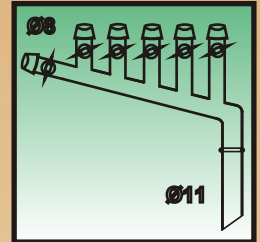

REAX-231

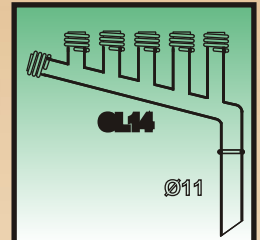

REAX-222

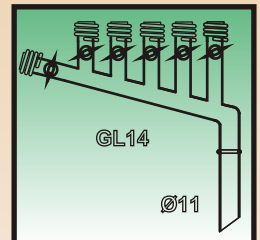

REAX-225

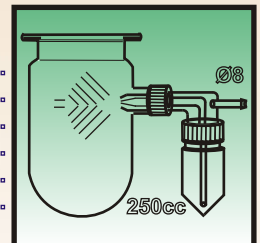

REAX-235

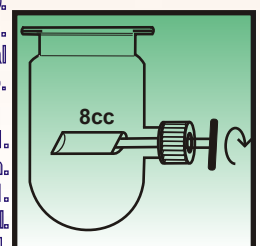

REAX-239

GLASS RAMPES	RAMPES EN VERRE	RAMPAS EM VIDRO	RAMPAS DE VIDRIO	GL14 Ø11 GL18	
Without valves-Sans robinets-Sem torneiras-Sin llaves		With valves-Avec robinets-Com torneiras-Con Llaves			
2	4	6	2	4	6
REAX-220	DREAX-221	REAX-222	REAX-223	REAX-224	REAX-225

GLASS RAMPES	RAMPES EN VERRE	RAMPAS EM VIDRO	RAMPAS DE VIDRIO	Olive Ø8 Ø11 GL18	
Without valves-Sans robinets-Sem torneiras-Sin llaves		With valves-Avec robinets-Com torneiras-Con Llaves			
2	4	6	2	4	6
REAX-226	REAX-227	REAX-228	REAX-229	REAX-230	REAX-231

FUNNELS	ENTONNOIRS	FUNIS	EMBUDOS
Glass-Verre-Vidro-Vidrio		Plastic-Plastique-Plástico-Plástico	
Ø80 f/p GL32		Ø100 Ø50 f/p GL45	
REAX-236		REAX-237	
		REAX-238	



REAX-232: Inlet tube Ø11 of PTFE for GL18 with olive Ø8, with all the surface drilled with holes of Ø1 mm.  
 REAX-233: Inlet tube Ø32 of PTFE for GL45 with olive Ø8, ended with a shower Ø60, drilled with Ø1 holes.  
 REAX-234: Inlet tube Ø11 of glass for GL18 with olive Ø8, ended with a porous glass Nr1 Ø90 plate.  
 REAX-235: Sprayer of 250cc, of glass, to spray the liquids into the reactor, through the lateral neck.  
 REAX-239: Turnable spoon 8cc glass made to allow to introduce solids through the lateral neck of the reactor  
 REAX-240: Flow Indicator, made of transparent plastic, able to start to work from 5 milliliters per second.



REAX-232: Tube d'entrée en PTFE Ø11 p/GL18 avec embout Ø8, avec la surface perforée avec trous Ø1.  
 REAX-233: Tube d'entrée en PTFE Ø32 p/GL45 avec embout Ø8, fini en douche Ø60, avec trous de Ø1.  
 REAX-234: Tube de barbotage en verre Ø11 p/GL18, avec embout Ø8 fini en plaque Ø90 en verre fritté n°1.  
 REAX-235: Pulverisateur en verre de 250cc, pour pulveriser dedans le réacteur, moyen le col lateral.  
 REAX-239: Cuillère giratoire, 8cc en verre, pour introduir produits solides moyen le col lateral du réacteur.  
 REAX-240: Indicateur de fluxe, en plastique transparent, pour indiquer circulation à partir de 5mls/seconde.



REAX-232: Tubo entrada em PTFE Ø11 p/GL18 com oliva Ø8, com a superfície perfurada com orifícios 1mm.  
 REAX-233: Tubo entrada em PTFE Ø32 p/GL45 com oliva Ø8, acabado num chuveiro com orifícios de 1mm.  
 REAX-234: Tubo entrada em vidro Ø11 p/GL18, com oliva Ø8, acabado num disco em vidro difusor n°1 Ø90.  
 REAX-235: Pulverizador em vidro de 250cc, para pulverizar dentro do reactor através de uma boca lateral.  
 REAX-239: Colher giratória 8cc em vidro para introduzir produtos sólidos dentro do reactor pela boca lateral  
 REAX-240: Indicador de fluxo para fluidos, em plástico transparente, trabalha desde 5mlts/segundo.



REAX-232: Tubo entrada de PTFE Ø11 para GL18, con oliva Ø8, con la superficie perforada con taladros Ø1.  
 REAX-233: Tubo entrada de PTFE Ø32 para GL45, con oliva Ø8, acabado en una ducha con taladros Ø1mm.  
 REAX-234: Tubo borbotado de vidro Ø11 para GL18, con oliva Ø8, acabado en disco difusor Ø90 de poro n°1.  
 REAX-235: Pulverizador 250cc de vidro, para pulverizar dentro del reactor, para introducir por la boca lateral.  
 REAX-239: Cuchara giratoria 8cc de vidrio para introducir productos sólidos en el reactor por la boca lateral.  
 REAX-240: Indicador de flujo de plástico transparente, funciona a partir de un caudal de 5mls por segundo.







REAX-170

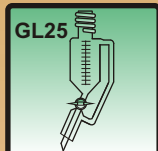

REAX-171

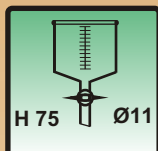

REAX-175  
REAX-176  
REAX-177

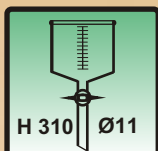

REAX-178  
REAX-179  
REAX-180

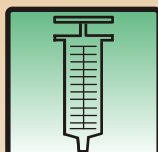

REAX-187  
REAX-188  
REAX-189  
REAX-190

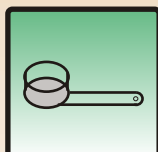

REAX-196  
REAX-197  
REAX-198

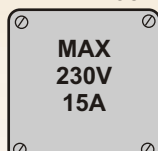

REAX-200



<b>ISOBAR GRADUATED DOSSING FUNNELS</b> Glass made Ø11 f/GL25	<b>AMPOULES DE COULEE GRADUEES ISOBARES</b> En verre Ø11 p/GL25	<b>FUNIS DE ADIÇÃO GRADUADOS ISOBARS</b> Em vidro Ø11 p/GL25	<b>EMBUDOS DE ADICION GRADUADOS ISOBARS</b> De vidrio Ø11 p/GL25
100cc REAX-170		250cc REAX-171	

<b>OPEN GRADUATED DOSSING FUNNELS</b> Short tube Ø11x35 for GL25	<b>AMPOULES DE COULEE GRADUEES OUVERTES</b> Tube court Ø11x35 p/GL25	<b>FUNIS DE ADIÇÃO GRADUADOS ISOBARS</b> Tubo curto Ø 11x35 p/GL25	<b>EMBUDOS DE ADICION GRADUADOS ABIERTOS</b> Tubo corto Ø11x35 p/GL25
24cc REAX-175	50cc REAX-176	100cc REAX-177	100cc REAX-180
High tube Ø11x310 f/GL25	Tube haut Ø11x310 p/GL25	Tubo alto Ø11x310 p/GL25	Tubo alto Øx310 p/GL25
24cc REAX-178	50cc REAX-179	100cc REAX-177	100cc REAX-180

<b>BURETS Ø18 GL32 WITH FLEXIBLE PLASTIC FLASK</b>	<b>BURETTES Ø18 GL32 AVEC FLACON PLASTIQUE FLEXIBLE</b>	<b>BURETAS Ø18 GL32 COM FRASCO PLÁSTICO FLEXÍVEL</b>	<b>BURETAS Ø18 GL32 CON FRASCO DE PLÁSTICO FLEXIBLE</b>
10cc REAX-181	25cc REAX-182	50cc REAX-183	

<b>MODULAR PERISTALTIC PUMPS</b> Timer controled (Basic unit)	<b>POMPE PERISTALTIQUE MODULAIRE</b> Contrôle par temporisateur	<b>BOMBAS PERISTALTICAS MODULARES</b> Controlo por temporizador	<b>BOMBAS PERISTALTICAS MODULARES</b> Control por temporizador
0,14-60mls./Minut. REAX-185		4,2-731mls./Minut. REAX-186	

<b>PLASTIC SYRINGES</b> With needle for "Septum"	<b>SERINGUES PLASTIQUE</b> Avec aiguille pour "Septum"	<b>SERINGAS EM PLASTICO</b> Com agulha para "Septum"	<b>JERINGAS DE PLASTICO</b> Con aguja para "Septum"
2cc REAX-187	5cc REAX-188	10cc REAX-189	20cc REAX-190

<b>MODULAR GAS DOSSING UNITS</b>	<b>UNITEES DE DOSSAGE DE GAS</b>	<b>UNIDADES DOSEADORAS DE GAZ</b>	<b>UNIDAD DOSIFICADORA GASES</b>
Composed by: On/Off inlet valve Rotameter Regulation valve Manometer Outlet electrovalve	Composées par: Vanne d'entrée On/Off Rotamètre Vanne regulation Manomètre Electrovanne de sortie	Compostas por: Válvula de entrada On/Off Rotâmetro Válvula de regulação Manómetro Eletroválvula de saída	Compuesta de: On/Off válvula de entrada Rotâmetro Válvula de regulación Manómetro Electroválvula de salida
Air/Aire/Ar/Aire REAX-191	CO2 REAX-192	N2 REAX-193	H2 REAX-194
			O2 REAX-195

<b>FLOW-METERS</b>	<b>ROTAMETRES</b>	<b>ROTÁMETROS</b>	<b>ROTAMETROS</b>
Nr	Air	CO2	N2
1	REAX-191/1	REAX-192/1	REAX-193/1
4	REAX-191/4	REAX-192/4	REAX-193/4
6	REAX-191/6	REAX-192/6	REAX-193/6
			H2
			REAX-194/1
			REAX-194/4
			REAX-194/6
			O2
			REAX-195/1
			REAX-195/6
			REAX-195/6

<b>GLASS DOSSING SPOONS</b>	<b>CUILLERES A DOSAGE EN VERRE</b>	<b>COLHERES DOSEADORAS EM VIDRO</b>	<b>CUCHARAS DE VIDRIO DOSIFICADORAS</b>
10cc REAX-196	25cc REAX-197	50cc REAX-198	

<b>DOSSING BY WEIGHT</b> Scale 2kg 0,1g provided with an electrical output to control an electrovalve	<b>DOSSAGE PAR POIDS</b> Balance 2kg 0,1g, munie avec une sortie électrique pour contrôler électrovanne	<b>DOSEADO POR PESO</b> Balança 2kg 0,1g, provida duma saída eléctrica para controlar eletroválvula	<b>DOSIFICADOR POR PESO</b> Balanza 2kg 0,1g, con una salida eléctrica para controlar una electroválvula
REAX-199	REAX-199	REAX-199	REAX-199
Relay to control the electrovalve	Relais pour contrôler une électrovanne	Relé para controlar uma eletroválvula	Relé para controlar una electroválvula
REAX-200	REAX-200	REAX-200	REAX-200

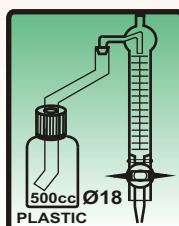

REAX-181

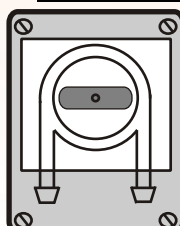

REAX-185

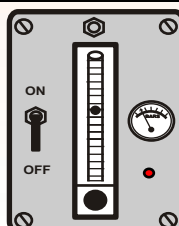

REAX-191

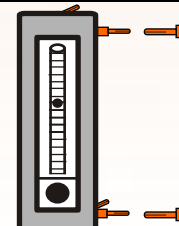

REAX-191/1

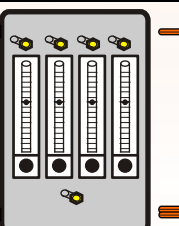

REAX-191/4

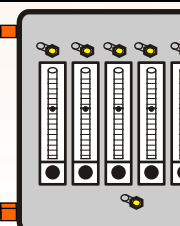

REAX-191/6

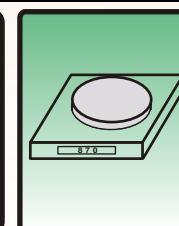

REAX-199





**REAX-122:** Up to REAX-123/2 are PTFE magnetic bars of different shapes and sizes. **REAX-124:** is a PTFE magnetic bars retriever. **REAX-125:** Electric shaft stirrer provided with a chuck for Ø1-10mm shafts, and it needs to work, a liquid joint REAX-136. **REAX-126:** Pneumatic shaft stirrer with chuck Ø1-10mm, it needs a glass liquid joint REAX-136, and an air compressor REAX-134. **REAX-127:** Electric shaft stirrer to be inserted in a GL32 neck, provided with a stainless steel shaft with 3 impellers of 6 blades. **REAX-128:** Electric vertical reciprocating motion stirrer to insert in a GL32 with stainless steel shaft ended in a drilled dish. **REAX-129:** Heating micro magnetic stirrer Ø85 of stainless steel, 100-1500RPM, 375°C, to heat+stir the microreactor REAX-118. **REAX-130:** Micro magnetic stirrer Ø85 with plastic housing, 100-1500RPM, provided with a rear stainless steel fixing bar. **REAX-131:** Magnetic stirrer without heating Ø110mm useful, insertable by Ø4 "PINS" or to hung through a Ø12 rear fixing bar. **REAX-132:** Magnetic stirrer no heating Ø110mm useful, insertable by Ø4 "PINS", 16L stirring power. **REAX-132D** digital version. **REAX-133:** Heating magnetic stirrer Ø135mm useful 16 L. **REAX-133D** digital. **REAX-1330** oval plate. **REAX-1330D** oval&digital **REAX-134** Air compressor of 8 bars of maximum pressure, 190 liters/min for the pneumatic stirrer REAX-126. External accessory. **REAX-135:** Magnetic transmission pump 5l/min with pump body made of PTFE, with olives Ø8 to recirculate & empty the reactor. **REAX-137:** Up to REAX-145: Stirring shafts, made of glass, PTFE, or stainless steel, and made in different shapes as well.

**REAX-122:** Jusqu'à REAX-123/2 sont barreaux magnétiques en PTFE de différentes formes et tailles. **REAX-124** est un extracteur. **REAX-125:** Agitateur électrique à tige avec mandrin Ø1-10 pour pouvoir travailler avec palier d'agitation étanche REAX-136. **REAX-126:** Agitateur pneumatique à tige avec mandrin Ø1-10, il a besoin du compresseur REAX-134+palier étanche REAX-136. **REAX-127:** Agitateur électrique muni avec une tige en Acier Inox avec 3 disques de 6 pales pour introduire dans un col GL32. **REAX-128:** Agitateur électrique avec mouvement de va-et-vien vertical sur une tige Inox finie en disque perforé, pour col GL32. **REAX-129:** Micro agitateur magnétique, boîtier en inox, chauffant Ø85 100-1500TPM, 375°C, spécial pour mini réacteur REAX-118. **REAX-130:** Micro agitateur magnétique, boîtier en plastique, Ø85 100-1500TPM, avec une tige en inox pour fixation postérieure. **REAX-131:** Agitateur magnétique non chauffant Ø110mm à fixer moyen "PINS" Ø4 ou pour suspendre moyen une tige de Ø12. **REAX-132:** Agitateur magnétique non chauffant Ø135mm à fixer moyen "PINS" Ø4 16L. **REAX-132D** version digital **REAX-133:** Agitat. magnét. chauffant Ø135 à fixer par pins Ø4 16L **REAX-133D** digital **REAX-1330** oval **REAX-1330D** oval digital **REAX-134:** Compresseur d'air externe de 8 bars de pression maximale, 190 litres/min pour l'agitateur pneumatique REAX-126. **REAX-135:** Pompe à transmission magnétique de 5l/min, avec corps en PTFE et embouts Ø8, pour recirculer et vider le réacteur. **REAX-137:** Jusqu'à REAX-145, sont tiges d'agitation de différentes formes, et fabriquées en verre, en PTFE, ou en acier inox.

**REAX-122:** Até REAX-132/2 são barras magnéticas de diferentes formas/ tamanhos em PTFE. **REAX-124** é um pescador de barras. **REAX-125:** Agitador eléctrico de haste com mandril para hastas Ø1-10, para poder trabalhar com o selo de agitação REAX-136. **REAX-126:** Agitador pneumático de haste com mandril Ø1-10 precisa um compressor DREAX-134+um selo de agitação REAX-136. **REAX-127:** Agitador eléctrico de haste provido de uma haste em aço inox com 3 discos de 6 pás, para introduzir numa boca GL32. **REAX-128:** Agitador eléctrico com movimento de vaivém vertical numa haste inox com disco com orifícios para boca GL32. **REAX-129:** Microagitador magnético aquecedor Ø85 chassi em inox, 100-1500RPM, 375°C para mini-reactor auxiliar REAX-118. **REAX-130:** Microagitador magnético Ø85, chassi em plástico, regulação 100-1500RPM, com barra posterior de fixação em inox. **REAX-131:** Agitador magnético sem aquecimento Ø útil 110 para fixar com "pins" Ø4 ou para colgar com uma barra Ø12mm. **REAX-132:** Agitador magnético sem aquecimento Ø útil 135 para fixar com "pins" Ø4 16L potência. **REAX-132D** versão digital. **REAX-133:** Agitador magnét. aquecedor Ø135 com pins Ø4 16L. **REAX-133D** digital. **REAX-1330** oval. **REAX-1330D** oval digital **REAX-134:** Compressor de ar externo com uma pressão máxima de 8 bars, 190 litros/min para o agitador pneumático REAX-126. **REAX-135:** Bomba modular de transmissão magnética 5l/min corpo bomba em PTFE olivas Ø8 para recircular e esvaziar o reactor. **REAX-137** Até REAX-145, são hastas de agitação de diferentes formas e estão fabricadas em vidro, PTFE, e aço inoxidável.

**REAX-122 a REAX-123/2** son varillas magnéticas en PTFE de diferentes formas y tamaños. **REAX-124** es un extractor de varillas. **REAX-125:** Agitador eléctrico de varilla superior con portabrocas Ø1-10, puede trabajar con el cierre de agitación REAX-136. **REAX-126:** Agitador neumático de varilla portabrocas Ø1-10, precisa un compresor REAX-134 y cierre de agitación REAX-136. **REAX-127:** Agitador eléctrico provisto con una varilla de acero inox con 3 discos de 6 palas, para insertar en una boca GL32. **REAX-128:** Agitador eléctrico de movimiento de vaivén vertical sobre varilla inox acabada en disco perforado para boca GL32. **REAX-129:** Microagitador magnético chasis inox, calefactor Ø85, 100-1500RPM, 375°C, especial para el reactor auxiliar REAX-118. **REAX-130:** Microagitador magnético Ø85, con chasis de plástico, regulación 100-1500RPM, con varilla de sujeción posterior. **REAX-131:** Agitador Magnético sin calefacción Ø útil 110mm insertable por "PINS Ø4" o suspendible por varilla posterior Ø12. **REAX-132:** Agitador Magnético sin calefacción Ø útil 135mm insertable por "PINS Ø4" 16L potencia. **REAX-132D** versión digital. **REAX-133:** Agitador Magnético calefactor Ø135 16 litros. **REAX-133D** digital, **REAX-1330** plato oval, **REAX-1330D** oval digital **REAX-134:** Compresor de aire externo con depósito con presión de 8 bars, 190 litros/min para el agitador neumático REAX-126. **REAX-135:** Bomba modular a transmisión magnética de 5l/min, cuerpo de PTFE, olivas Ø8, para recirculación y vaciado del reactor. **REAX-137** A REAX-145: Son varillas agitadoras de diversos formatos y fabricadas de vidrio, PTFE, ó de acero inoxidable.

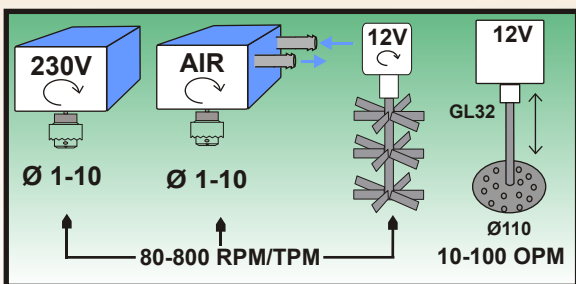

REAX-134

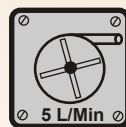

REAX-135

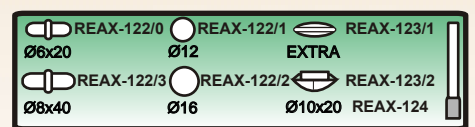

PTFE

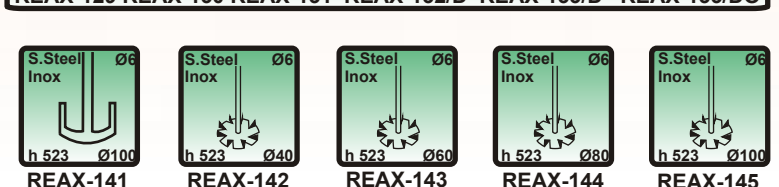
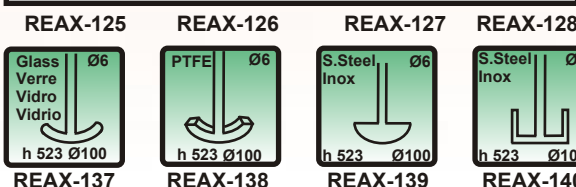



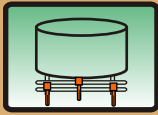

REAX-153

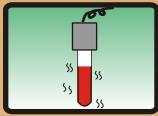

REAX-154

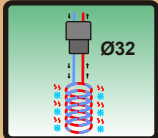

REAX-156

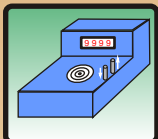

REAX-157

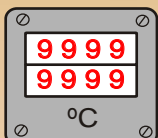

REAX-159

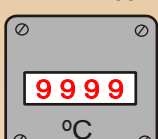

REAX-160



REAX-163

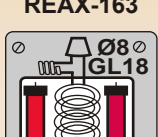

REAX-161

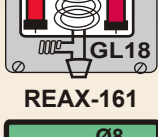

REAX-162

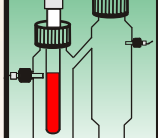

REAX-162



REAX-169



REAX-169



**REAX-152: Plain top hot plate:** It's a modular Ø4 pin interchangeable aluminium 700W to heat flat bottom reactors  
**REAX-153: Ceramic safety mantle:** It's modular, of 500W. It can heat by contact, by air, by sand or as bath.  
**REAX-154: Cylindrical immersion heater** made of quartz, of Ø11x260mm, 1000W to be inserted in a GL18 neck.  
**REAX-155: Cylindrical immersion heater** made of quartz, of Ø11x100mm, 200W to be inserted in a GL18 neck.  
**REAX-156: Immersion glass coil** for a GL45 neck, to circulate thermostated liquid from an external bath:  
**REAX-157: Circulation bath amb +5°C+200°C,** it's controlled by the basic unit, to thermostatize the reactors.  
**REAX-158: Circulation bath -15°C+200°C,** it's regulated by the basic unit, intended for reactors thermostatization.  
**REAX-159: Auxiliar temperature regulator,** by a modular digital microprocessor. It needs a Pt100 to choice.  
**REAX-160: Digital thermometer,** it's modular, from -20°C up to +600°C. It needs a Pt-100 test probe, to choice.  
**REAX-161: Tubular micro oven,** 90W, to preheat fluids up to 250°C through a glass coil of 1170mm Ø5. Provided with a GL 18 in the inlet and other in the outlet, for 2 PT100, to know the inlet and outlet temperatures.  
**REAX-162 Steam generator,** of 1liter, with a 2000W heater, provided with an automatic water level control, and a safety over-heating thermostat system; it is made of borosilicate glass. Outlet with a Ø8 olive.  
**REAX-169: Digital immersion thermometer** -20 +600°C with stainless steel Ø4x200mm test probe incorporated.



**REAX-152: Plaque chauffante plane** modulaire pins Ø4, 700Watts pour chauffer des réacteurs à fond plain.  
**REAX-153: Mante céramique de sécurité** modulaire de 500W. Peut chauffer à contact, à aire, à sable, à liquide.  
**REAX-154: Résistance chauffante à immersion** en quartz 1000W, cylindrique de Ø11x260mm pour col GL18.  
**REAX-155: Résistance chauffante à immersion** en quartz 200W, cylindrique de Ø11x100mm pour col GL18.  
**REAX-156: Serpentin à immersion** en verre pour un col GL45 où circule liquide provenant d'un bain externe:  
**REAX-157: Bain à circulation Amb+5°C à +200°C** contrôlé par l'unité basique pour thermostatizer les réacteurs.  
**REAX-158: Bain à circulation -15°C à +200°C,** contrôlé par l'unité basique, pour thermostatizer les réacteurs.  
**REAX-159: Régulateur de température** auxiliaire à affichage numérique, Il faut compléter avec une sonde Pt100.  
**REAX-160: Thermomètre** à affichage numérique modulaire -20 +600°, Il faut compléter avec une sonde Pt100.  
**REAX-161 Micro four tubulaire,** 90W, pour prechauffer fluides jusqu'à 250°C, moyen un sepentin en verre Ø5 de 1170mm. Avec un GL18 dans l'entrée et autre à la sortie, pour 2 PT100, pour voir les températures.  
**REAX-162: Générateur de vapeur** en verre, avec capacité de 1litre, avec 2000W puissance, équipé avec un contrôle automatique du niveau de l'eau, thermostat de sécurité de sur-chauffe et olive de sortie Ø8.  
**REAX-169: Thermomètre à immersion numérique** -20+600°C avec sonde incorporée d'acier inox Ø4x200mm.



**REAX-152: Prato aquecedor plano,** modular pins Ø4 de 700 W para aquecer os reatores com o fundo plano.  
**REAX-153: Manta cerâmica de segurança,** modular de 500W. Pode aquecer por contacto, ar, areia ou banho.  
**REAX-154: Resistência aquecedora de imersão** em quartz, cilíndrica Ø11x260mm 1000W, para boca GL18  
**REAX-155: Resistência aquecedora de imersão** em quartz, cilíndrica Ø11x100mm 200W, para boca GL18  
**REAX-156: Serpentina a imerção** em vidro para uma boca GL45, para circular líquido dum banho externo:  
**REAX-157: Banho a circulação Amb+5°C+200°C,** controlado pela unidade básica, para termostatar reatores.  
**REAX-158: Banho a circulação** desde -15° +200°C controlado pela unidade básica para termostatar reatores.  
**REAX-159: Regulador de temperatura** digital auxiliar a microprocessador. Necessita usar uma sonda PT-100.  
**REAX-160: Termómetro de leitura digital** modular desde -20°C até +600°C. Necessita usar uma sonda PT-100.  
**REAX-161: Micro forno tubular,** 90W, para preaquecer fluidos até 250°C, com uma serpentina em vidro Ø5 de 1170mm. Com uma GL18 na entrada e outra na saída, para 2 PT100, para medir as temperaturas.  
**REAX-162: Gerador de vapor** em vidro, com capacidade de 1000cc e 2000W, equipado com sistema de control automático do nível da água, e termostato de segurança de sobre-temperatura, saída oliva Ø8.  
**REAX-169: Temómetro a inmerção a leitura digital** -20+600°C com sonda incorporada em aço inox Ø4x200mm



**REAX-152: Plato calefactor plano** modular pins Ø4 de aluminio, de 700W para calentar reatores de fondo plano.  
**REAX-153: Manta cerámica de seguridad:** Modular de 500W. Puede calentar por contacto, aire, arena o baño.  
**REAX-154: Resistencia calefactora para inmersión** de cuarzo, cilíndrica Ø11x260mm 1000W para boca GL18.  
**REAX-155: Resistencia calefactora para inmersión** de cuarzo, cilíndrica Ø11x100mm 200W para boca GL18.  
**REAX-156: Serpentin para inmersión** de vidrio para GL45, para circular líquido procedente de un baño externo.  
**REAX-157: Baño de circulación amb+5°C+200°C** controlado por la unidad básica para termostatar reatores.  
**REAX-158: Baño de circulación -15°C +200°C,** controlado por la unidad básica para termostatar reatores.  
**REAX-159: Regulador temperatura digital** auxiliar a microprocesador, precisa una sonda Pt-100 a escoger.  
**REAX-160: Termómetro digital** modular, desde -20°C a +600°C. Precisa el uso de una sonda Pt-100 a escoger.  
**REAX-161: Micro horno tubular,** 90W, para precalentar fluidos hasta 250°C, con un serpentin de vidrio Ø5 de 1170mm. Con una GL18 en la entrada y otra en la salida, para 2 PT100, para medir las temperaturas.  
**REAX-162: Generador de vapor** de 1000cc de capacidad, de vidrio, y 2000 Watios, equipado con control de nivel de agua automático y termostato de seguridad contra sobrecalentamiento, tubo de salida oliva de Ø8.  
**REAX-169: Termómetro digital a inmersión** -20 +600°C con su sonda incorporada de acero inox Ø4x200mm.

PT-100					
STAINLESS STEEL-INOX		GLASS-VERRE-VIDRO-VIDRIO		PTFE	
Ø8x70mm	Ø6x350mm	Ø8x70mm	Ø8x200mm	Ø7x200mm	Ø8x300mm
REAX-163	REAX-164	REAX-165	REAX-166	REAX-167	REAX-168





PLASTIC SCREWDED CAPS BOUCHONS EN PLASTIQUE TAMPÕES EM PLÁSTICO TAPONES DE PLASTICO



REAX-330

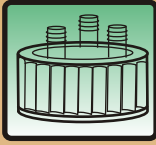
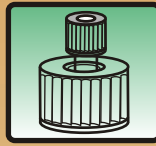
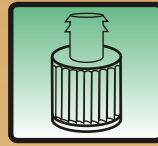
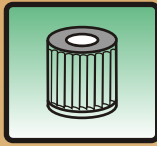
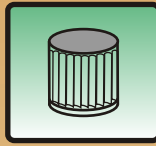

REAX-334

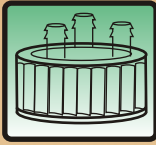

REAX-337

GL	Closed-Fechados Fermés-Cerrado	Open-Aberto Ouvert-Abierto	Ø8Olive-Oliva Embout-Oliva	Ø8 45°Olive-Oliva Embout-Oliva	With-Avec-Com- con 1x GL18 Ø8
14	REAX-300	REAX-305	REAX-315	REAX-320	---
18	REAX-301	REAX-306	REAX-316	REAX-321	---
25	REAX-302	REAX-307	---	---	REAX-324
32	REAX-303	REAX-308	---	REAX-322	REAX-325
45	REAX-304	REAX-309	---	REAX-323	REAX-326

GL45 DISTRIBUTORS				DISTRIBUTEURS GL45		DISTRIBUIDORES GL45		DISTRIBUIDORES GL45	
For tubes-Pour tubes-Para tubos-Para tubos				With GL-Avec GL-Com GL-Con GL		Ø8 Olive-Embout Ø8-Oliva		Ø8-Oliva Ø8	
4x Ø1.6	4x Ø2.1	4x Ø4	4x Ø6	3x GL14	3x GL18	2	3	4	
REAX-330	REAX-331	REAX-332	REAX-333	REAX-334	REAX-335	REAX-336	REAX-337	REAX-338	



PTFE+SILICON JOINTS		JOINTS EN PTFE+SILICONE		JUNTAS EM PTFE+SILICONE		JUNTAS DE PTFE+SILICONA	
GL14	REAX-340	REAX-341	Ø4	REAX-342	Ø5.5-6.5	---	---
GL18	REAX-345	REAX-346	Ø5.5-6.5	REAX-347	Ø7.5-9	REAX-348	Ø9-11
GL25	REAX-350	REAX-351	Ø7.5-9	REAX-352	Ø9-11	REAX-353	Ø11-13
GL32	REAX-355	REAX-356	Ø9-11	REAX-357	Ø11-13	REAX-358	Ø13-15
GL45	REAX-361	REAX-362	Ø25-27	REAX-363	Ø31-33	---	---
		REAX-359	Ø15-17	REAX-360	Ø17-19		



REAX-370

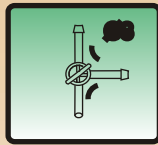

REAX-371

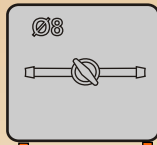

REAX-372

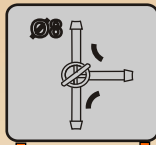

REAX-373

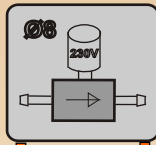

REAX-389

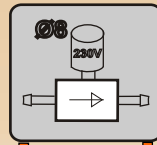

REAX-390

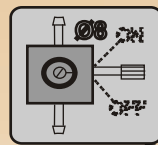

REAX-391

GLASS	VERRE	VIDRO	VIDRIO	+PTFE
INSERTABLE-INSERIVEL		MODULAR		
Ways-Voies-Vias-Vías		Ways-Voies-Vias-Vías		
1	2	1	2	
REAX-370	REAX-371	REAX-372	REAX-373	

ELECTROVALVES		On/Off st. steel valve
ELECTROVANNES		On/Off vanne en Inox
ELECTROVÁLVULAS		On/Off válvula em inox
St. steel-Inox	PTFE	On/Off válvula de inox
REAX-389	REAX-390	REAX-391

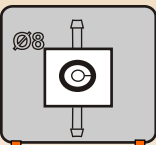

REAX-380



REAX-381

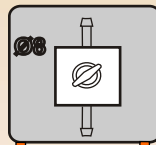

REAX-382

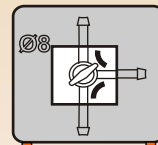

REAX-383

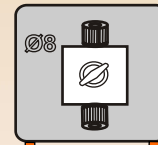

REAX-384

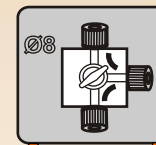

REAX-385

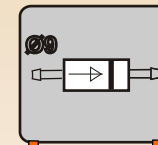

REAX-386

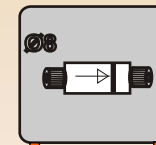

REAX-387

PTFE MODULAR VALVES		VANNES MODULAIRES PTFE		VALVULAS MODULARES PTFE		LLAVES MODULARES PTFE	
REGULATION-REGULATION REGULAÇÃO-REGULACION		PASS-PASE-PASO-PASO				ANTI RETURN-RETOUR-RETORNO	
Ø8 OLIVES EMBOUS		For/Pour/Para tubes/tubos		Ø8 Olives-Embouts-Olivas		Ø8 For tubes-Pour tubes-Para Tubos	
Normal 1 via		T		Normal 1via		T	
REAX-380	REAX-381	REAX-382	REAX-383	REAX-384	REAX-385	REAX-386	REAX-387

GLASS UNIONS	CONNEXIONS EN VERRE	LIGAÇÕES EM VIDRO	UNIONES DE VIDRIO	
	GL14-Ø6 REAX-400	GL18-Ø8 REAX-401	GL18-Ø11 REAX-402	GL25-Ø13 REAX-403
	GL14-GL14 REAX-406	GL18-GL18 REAX-407	---	GL25-GL25 REAX-408
	GL14-GL18 REAX-411	GL14-GL25 REAX-412	GL14-GL32 REAX-413	GL32-Ø18 REAX-404
	GL18-GL25 REAX-415	GL18-GL32 REAX-416	GL18-GL45 REAX-417	GL32-GL32 REAX-409
	GL25-GL32 REAX-418	GL25-GL45 REAX-419	---	GL45-GL45 REAX-410
	GL32-GL45 REAX-420	---	---	
	Ø8 REAX-421	GL18 REAX-422	GL25 REAX-423	GL32 REAX-424
			GL45 REAX-425	---





**FILTRATION FILTRATION FILTRAÇÃO FILTRACION**

<b>FUNNELS WITH POROUS GLASS PLATE, 125cc OF GLASS Ø11 FOR GL18 TO WORK WITH VACUUM</b>				
<b>ENTONNOIRS 125cc EN VERRE A PLAQUE FILTRANTE EN VERRE FRITE, Ø11 POUR GL18, POUR VIDE</b>				
<b>FUNIS EM VIDRO DE 125cc COM PLACA FILTRAÇÃO EM VIDRO POROSO, Ø11 PARA GL18, PARA VÁCUO</b>				
<b>EMBUDOS FILTRANTES 125cc DE VIDRIO, CON PLACA VIDRIO POROSO, Ø11 PARA GL 18, PARA VACIO</b>				
Pore N°0	Pore N°1	Pore N°2	Pore N°3	Pore N°4
REAX-430	REAX-431	REAX-432	REAX-433	REAX-434



REAX-430

<b>FUNNELS WITH POROUS GLASS PLATE, Ø11, 125cc GLASS FOR GL18 TO WORK WITH PREASURE</b>				
<b>ENTONNOIRS 125cc EN VERRE A PLAQUE FILTRANTE VERRE FRITE, Ø11 POUR GL18, POUR PRESSION</b>				
<b>FUNIS EM VIDRO 125cc COM PLACA FILTRAÇÃO EM VIDRO POROSO, Ø11 PARA GL18, PARA PRESSÃO</b>				
<b>EMBUDOS FILTRANTES 125cc DE VIDRIO CON PLACA VIDRIO POROSO Ø11 PARA GL 18, PARA PRESION</b>				
PORE N°0	PORE N°1	PORE N°2	PORE N°3	PORE N°4
REAX-435	REAX-436	REAX-437	REAX-438	REAX-439

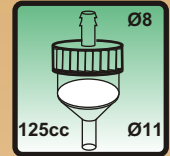

REAX-435

**REAX-440**  
**Filtration kit, modular, glass 300cc for membranes Ø47, composed by: Pore Nr3 plate, funnel, and clamp.**  
**Kit filtration pour membranes Ø47 en verre, 300cc composé par: Entonnoir, plaque porosité N°3, et pince.**  
**Kit de filtração p/membranas Ø47 em vidro, 300cc, composta por: Funil, placa porosidade N°3, e pinça.**  
**Kit de filtración p/membranas Ø47 de vidrio, 300cc, compuesta por: Embudo, placa con poro N°3 y pinza.**

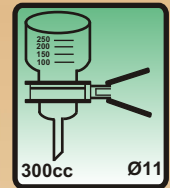

REAX-440

<b>"ON LINE" FILTERS Ø25 FOR STERILIZATION</b>	<b>FILTRES "ON LINE" Ø25 POUR STERILIZATION</b>	<b>FILTROS "ON-LINE" Ø25 PARA ESTERILIZAÇÃO</b>	<b>FILTROS "ON LINE" Ø25 PARA ESTERILIZACION</b>
Hydrophobic-Hydrophobes-Hydrofobos-Hidrófobos	Hydrophobic-Hydrophobes-Hydrofobos-Hidrófobos	Hydrophilic-Hydrophilics-Hydrofilicos-Hidrofilicos	Hydrophilic-Hydrophilics-Hydrofilicos-Hidrofilicos
Pore-Poro 0.2micras	Pore-Poro 0.45 micras	Pore-Poro 0.2micras	Pore-Poro 0.45micras
REAX-450	REAX-451	REAX-452	REAX-453

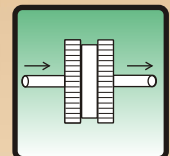

REAX-450

**BUBBLING BARBOTAGE BORBULHAÇÃO BORBOTEIO**

**REAX-460**  
**Bottle of 250cc made of glass for bubbling and cleaning gas.**  
**Flacon 250cc en verre pour nettoyer des gas par barbotage.**  
**Frasco em vidro de 250cc para a limpeza dos gases.**  
**Frasco de vidrio de 250cc parar lavar gases por borboteio.**

**REAX-461**  
**It's the REAX-460, plus a pore n° 1 filter.**  
**C'est le REAX-460, plus un filtre pore n° 1.**  
**É o REAX-460, porem com filtro poro n° 1.**  
**Es el REAX-460, mas un filtro poro n° 1.**

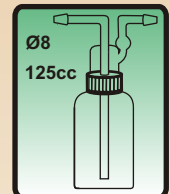

REAX-460

**UV STERILIZATION STERILIZATION A UV ESTERILIZAÇÃO A UV ESTERILIZACION A UV**

**REAX-470 1 unit REAX-472 4 units REAX-473 6 units**  
**STERILIZER FINGER BY IMMERSION Ø19 tube, of 8W 254nm ultraviolet radiation, for a GL32 neck.**  
**TUBE STERILIZATEUR A IMMERSION Ø19, par 8W radiation ultra-violet 254nm, pour un col GL32.**  
**TUBO ESTERILIZADOR DE IMERSÃO Ø19, com 8W radiação ultravioleta 254nm, para boca GL32.**  
**TUBO ESTERILIZADOR A INMERSIÓN Ø19, con 8W radiación ultravioleta 254nm, para boca GL32.**

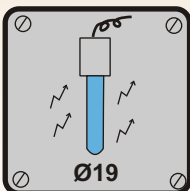

REAX-470

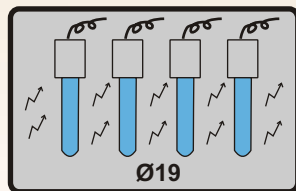

REAX-472

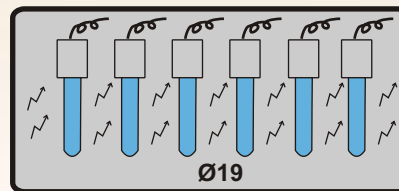

REAX-473

**REAX-471**  
**ESTERILIZATION CHAMBER for fluids in circulation, through a coil 604mm length, by 16W of UV 254nm.**  
**CHAMBRE STERILIZATION pour fluides en circulation par un sepentin de 604mm, par 16W de UV254nm.**  
**CAMARA ESTERILIZADORA para fluidos em circulação por uma serpentina 604mm, por 16W UV254nm.**  
**CAMARA ESTERILIZADORA para fluidos en circulación por un serpentín de 604mm, por 16W UV254nm.**

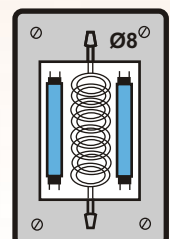

REAX-471







**IRRADIATION IRRADIATION IRRADIAÇÃO IRRADIACION**

**IMMERSION Ø19 LIGHTING TUBES** of 8W of day light REAX-480, and UV-366 REAX-481, for GL32 neck.  
**TUBES ILLUMINATEURS Ø19 A PLONGER** 8W, REAX-480 lumière du jour, REAX-481 UV-366 pour GL32.  
**TUBOS ILUMINADORES Ø19 A IMERSÃO**, DE 8W, REAX-480 luz do dia, REAX-481 UV-366, para GL32.  
**TUBO ILUMINADORES Ø19 DE INMERSIÓN** 8W, REAX-480 luz de día, REAX-481 UV-366 para GL32.

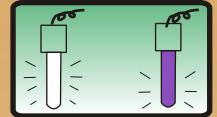

REAX-480 REAX-481

Involving screen to light the reactor; by 18x 8W bulbs to choice, supplied without bulbs, to order separately.  
 Ecran lumineuse pour ceindre autour du réacteur; avec 16 tubes 8W à choisir, fourni sans lampes, à demander  
 Iluminador-ecrã envolvente do reactor 16 lâmpadas 8W a escolher, fornecido sem lâmpadas, encomendar  
 Iluminador-pantalla envolvente para reactor, con 18 tubos 8W a escoger, suministrado sin tubos, pedir aparte.

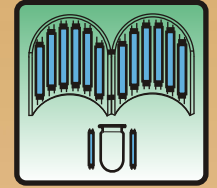

REAX-490

BULBS		LAMPES	LÂMPADAS	TUBOS		
4W		8W				
Day-Jour Dia-Día	UV-254	UV-366	Day-Jour Dia-Día	Actinic-Actinique Actínica	UV-254	UV-366
REAX-491	REAX-492	REAX-493	REAX-494	REAX-495	REAX-496	REAX-497

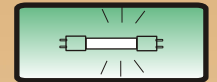

REAX-491

**PHOTOREACTORS** Glass coil of 604mm of length, to circulate fluids, and irradiating with 16 Watts of light.  
**PHOTOREACTEURS** Serpentin en verre 604mm longueur pour circuler fluides et irradier avec 16W de lumière.  
**FOTOREACTORES** Serpentina em vidro 604mm percorrido, para circular fluídos e irradiar com 16W de luz.  
**FOTOREACTORES** Serpentin de vidrio 604mm recorrido, para circulación de fluídos e irradiar con 16W luz.

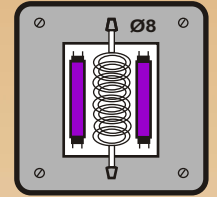

REAX-499

**MEASURING+CONTROL MESURE+CONTROL MEDIDA+CONTROLE MEDIDA+CONTROL**

All modular, digitals, and supplied with a test probe .The Ph-meter and the Conductivimeter, have 2 adjustable consign points.  
 Tous sont digitals, modulaires et fournis avec leur sonde. Le Ph-mètre et le Conductimètre, ont deux points de consigne réglables.  
 Todos são modulares digitais, fornecidos com a sua sonda. O pH-métro e o Conductímetro, têm 2 pontos de prefixação reguláveis.  
 Todos son modulares digitales. Suministrados con sonda. El Ph-metro y el conductímetro poseen 2 puntos de consigna ajustables.

PH-meter PH-mètre PH-métro PH-metro	Conductimeter Conductimètre Conductímetro Conductimetro	Oximeter Oximètre Oxímetro Oxímetro	Manometer Manomètre Manómetro Manómetro	Gauge Vacuomètre Vacuómetro Vacuómetro	Liquid Level Niveau liquid Nível líquido Nível líquido	Foam Level Niveau mousse Nível espuma Nível espuma	Presostat Presostate Presostato Presostato
0-14	0-200mS	0-20%	0-5 Bars	0-1100mBars	--	--	0-5Bars
Ø12 GL25	Ø12 GL25	Ø12 GL25	Ø12 p/GL25	Ø8 GL18	Ø8 GL18	Ø8 GL18	Ø12 p/GL25
REAX-500	REAX-501	REAX-502	REAX-504	REAX-505	REAX-506	REAX-507	REAX-508

**POWER SUPPLIES SOURCES D'ALIMENTATION ALIMENTADORES FUENTES DE ALIMENTACION**

**REAX-520:** Spark generator      Générateur d'étincelles      Gerador de faíscas      Generador de chispas  
**REAX-521:** For Incandescent wire      Pour un fil incandescent      Para fio incandescente      Para hilo incandescente  
**REAX-522:** For electrolysis      Pour electrolyse      Para electrólise      Para electrolisis

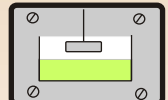

REAX-506

REAX-520	REAX-521	REAX-522	REAX-523	REAX-524	REAX-526	REAX-527	REAX-528	REAX-529	REAX-530

**ELECTRODES ELECTRODES ELÉTROS ELECTRODOS**

**REAX-524:** Unipolar Platinum      Unipolar en Platinium      Unipolar em platina      Unipolar de Platino  
**REAX-525:** Unipolar Stainless steel      Unipolar Acier Inox      Unipolar em aço inox      Unipolar Acero Inox  
**REAX-526:** Double of Platinum      Double en Platinium      Duplo em platina      Bipolar de Platino  
**REAX-527:** Couple Winkler Platinum      Couple Winkler Platinium      Kit Winkler em platina      Pareja Winkler de Pt  
**REAX-528:** Sample fixing clamps      Pincas pour echantillons      Garras para amostras      Pinzas para muestras

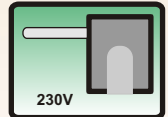

REAX-540

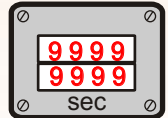

REAX-541

**MISCELLANEOUS DIVERS VÁRIOS VARIOS**

**REAX-540:** Electromagnet      Electro-aimant      Electroiman      Electroimán  
**REAX-541:** Cyclical Timer      Temporisateur cyclique      Temporizador cíclico      Temporizador cíclico  
**REAX-542:** Safety Screen      Ecran de securitée      Ecrã de segurança      Pantalla seguridad  
**REAX-543:** 50 steeps controller      Contrôleur 50 etapes      Controlador 50 pasos      Control de 50 pasos  
**REAX-544:** Software for PC      Software pour PC      Software para PC



REAX-542





RECIPIENTS RECIPIENTS RECIPIENTES RECIPIENTES



BALOONS ROUND BOTTOM		BALLONS A FOND ROND				BALÕES FUNDO REDONDO		BALONES FONDO REDONDO	
Standar (REAX-600 GL18)						With-Avec-Com-Con LATERAL GL18			
60cc REAX-600	100cc REAX-601	250cc REAX-602	500cc REAX-603	1000cc REAX-604	2000cc REAX-605	100cc REAX-607	250cc REAX-608	500cc REAX-609	1000cc REAX-610

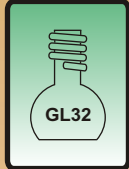
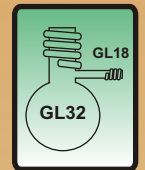

BALOONS FLAT BOTTOM		BALLONS A FOND PLAIN		BALÕES FUNDO PLANO		BALONES FONDO PLANO	
Standar				With-Avec-Com-Con LATERAL GL18			
100cc REAX-615	250cc REAX-616	500cc REAX-617	1000cc REAX-618	100cc REAX-622	250cc REAX-623	500cc REAX-624	1000cc REAX-625

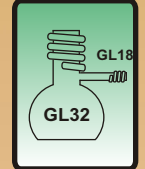

ERLENMEYERS				KIT ASATOS			
Standar				With-Avec-Com-Con LATERAL GL18			
100cc REAX-630	250cc REAX-631	500cc REAX-632	1000cc REAX-633	100cc REAX-637	250cc REAX-638	500cc REAX-639	1000cc REAX-640

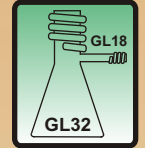

ERLENMEYERS		ERLENMEYERS		ERLENMEYERS		ERLENMEYERS	
With-Avec-Com-Con LATERAL GL25 Down				With-Avec-Com-Con 2 LATERAL GL18			
100cc REAX-645	250cc REAX-646	500cc REAX-647	1000cc REAX-648	100cc REAX-652	250cc REAX-653	500cc REAX-654	1000cc REAX-655



FLASKS		FLACONS		FRASCOS		FRASCOS	
Standar				With-Avec-Com-Con LATERAL GL18			
100cc REAX-660	250cc REAX-661	500cc REAX-662	1000cc REAX-663	100cc REAX-667	250cc REAX-668	500cc REAX-669	1000cc REAX-670

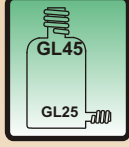

FLASKS		FLACONS		FRASCOS		FRASCOS	
With-Avec-Com-Con LATERAL GL25 Down				With-Avec-Com-Con LATERAL 2 GL18			
100cc REAX-675	250cc REAX-676	500cc REAX-677	1000cc REAX-678	100cc REAX-682	250cc REAX-683	500cc REAX-684	1000cc REAX-685

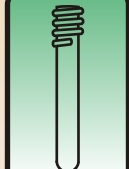
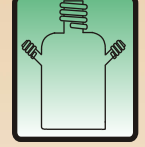

TUBES		TUBES		TUBOS		TUBOS	
Standard						Graduated-Gradués-Graduados	
25cc Ø22 GL25 h 100 REAX-690	55cc Ø22 GL25 h 220 REAX-691	60cc Ø30 GL32 h 100 REAX-692	135cc Ø30 GL32 h 220 REAX-693	138cc Ø42 GL45 h 100 REAX-694	305cc Ø42 GL45 h 220 REAX-695	100cc Ø26 GL32 h 300 REAX-697	250cc Ø42 GL45 h 300 REAX-698

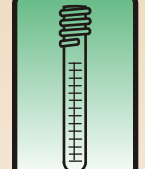

TUBES		TUBES			TUBOS			TUBOS		
With-Avec-Com-Con 1x GL14 45°					With-Avec-Com-Con 1GL14/45° Graduated-Gradués-Graduado					
25cc Ø22 GL25 h 80 REAX-700	50cc Ø30 GL32 h 100 REAX-701	100cc Ø42 GL45 h 100 REAX-702	250cc Ø42 GL45 h 200 REAX-703	500cc Ø46 GL45 h 300 REAX-704	25cc Ø22 GL25 h 80 REAX-706	50cc Ø30 GL32 h 100 REAX-708	100cc Ø42 GL45 h 100 REAX-710	250cc Ø42 GL45 h 200 REAX-711	500cc Ø46 GL45 h 300 REAX-712	

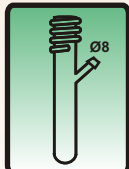
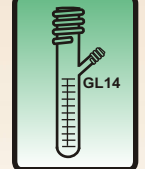

TUBES		TUBES			TUBOS			TUBOS		
With-Olive-Avec embout-Com Oliva-Con Oliva					With-Avec-Com-Con GL14 45°					
25cc Ø22X80 GL25 REAX-715	100cc Ø42X100 GL32 REAX-716	250cc Ø42X220 GL45 REAX-718	25cc Ø22X100 GL25 REAX-722	60cc Ø30X100 GL32 REAX-723	100cc Ø65X300 GL45 REAX-724					

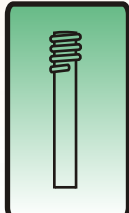

FLAT BOTTOM TUBES			TUBES A FOND PLAIN		TUBOS FUNDO PLANO			TUBOS FONDO PLANO	
Standard					Graduated-Gradués-Graduados-Graduados				
55cc Ø22 GL25 h 220 REAX-728	60cc Ø30 GL32 h 100 REAX-729	135cc Ø30 GL32 h 220 REAX-730	100cc Ø42 GL45 h 100 REAX-731	250cc Ø42 GL45 h220 REAX-732	55cc Ø22 GL25 h 220 REAX-736	60cc Ø30 GL32 h 100 REAX-737	135cc Ø30 GL32 h 220 REAX-738	100cc Ø42 GL45 h 100 REAX-739	250cc Ø42 GL45 h220 REAX-740

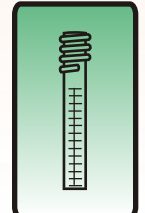



**DISTILLATION** **DISTILLATION** **DESTILAÇÃO** **DESTILACION**

**COLUMNS** **COLONNES** **COLONAS** **COLUMNAS**

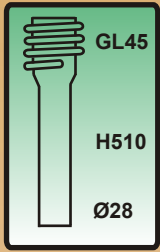

REAX-750



REAX-751

REAX-750:	SMOOTH	LISSE	LISA	LISA
REAX-751:	VIGREUX	VIGREUX	VIGREUX	VIGREUX
REAX-752:	PLATS	PLATEAUX	PRATOS	PLATOS
REAX-753:	BRUUN	BRUUN	BRUUN	BRUUN

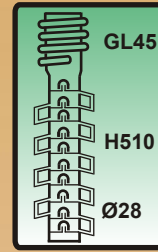

REAX-752

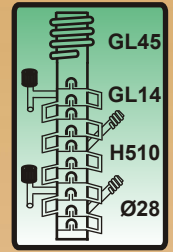

REAX-753

**HEADS** **TETES** **CABEÇAS** **CABEZALES**

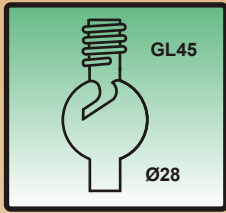

REAX-760

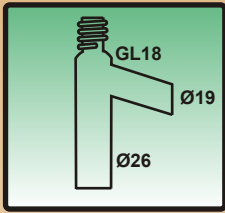

REAX-761

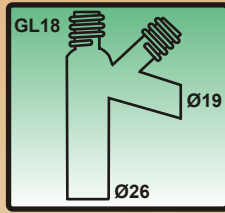

REAX-762

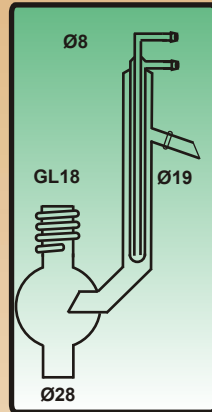

REAX-763

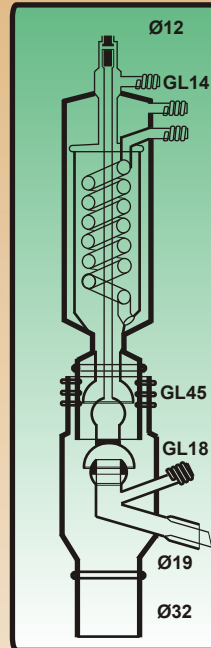

REAX-765

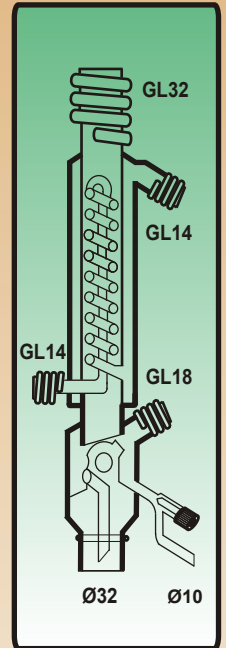

REAX-764

<b>REAX-760:</b> Kjeldahl Ball Anti-Foam	<b>Boule</b> Kjeldahl anti-mousse
<b>REAX-761:</b> "T" distillation head	<b>Tête</b> en "T"
<b>REAX-762:</b> "K" distillation head	<b>Tête</b> en "K"
<b>REAX-763:</b> Cool Finger head	<b>Tête</b> avec <b>doigt</b> froid
<b>REAX-764:</b> Handy head	<b>Tête</b> manuelle
<b>REAX-765:</b> Automatic head	<b>Tête</b> automatique
<b>REAX-766:</b> Jumper tube f/REAX-750	<b>Tube</b> à jonction p/REAX-750

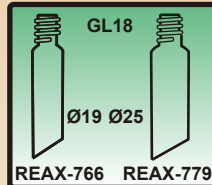

REAX-766 REAX-779

**CONDENSERS** **REFRIGERANTS** **CONDENSADORES** **REFRIGERANTES**

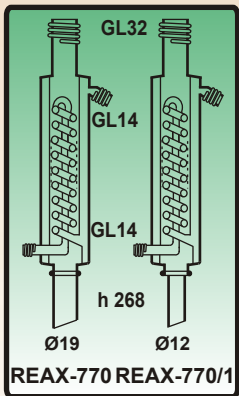

REAX-770 REAX-770/1

<b>REAX-770:</b> A double effect condenser with a coil of 695mm length of tube with Ø6 internal.
<b>REAX-770:</b> C'est un réfrigérant à double effet, avec serpentín de 695mm longueur de tube Ø6 interieur.
<b>REAX-770:</b> É um condensador de duplo efeito, com serpentina de 695mm comprido de tubo Ø6 interno
<b>REAX-770:</b> Refrigerante de doble efecto, con un serpentín de 695mm de largo, de tubo de Ø6 interno.

**COLECTORS** **COLECTEURS** **COLECTORES** **COLECTORES**



REAX-775

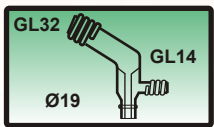

REAX-776

<b>REAX-775:</b> Atmospheric cone	Allonge coudé atmosphérique	Colector Atmosférico	Colector Atmosférico
<b>REAX-776:</b> Vacuum cone	Allonge coudé à vide	Colector a vácuo	Colector a vacío
<b>REAX-777:</b> Bertrand separator	Séparateur de Bertrand	Separador de Bertrand	Separador de Bertrand
<b>REAX-778:</b> Pauli separator	Séparateur de Pauli	Separador de Pauli	Separador de Pauli

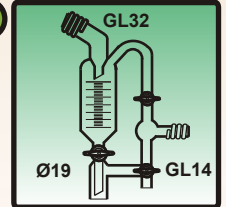

REAX-777

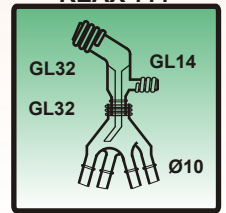

REAX-778







MISCELLANEOUS | DIVERS | VÁRIOS | VARIOS

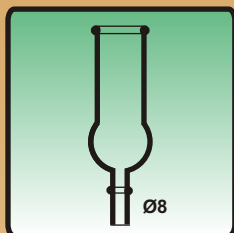

REAX-785

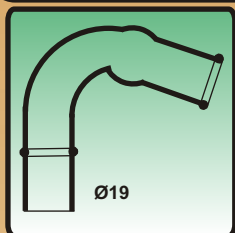

REAX-786

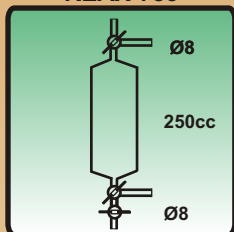

REAX-787

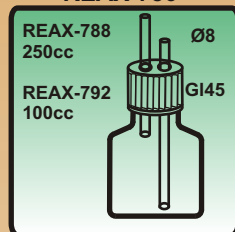

REAX-788

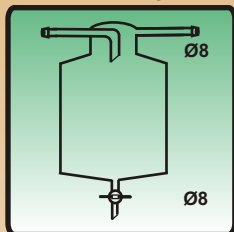

REAX-789

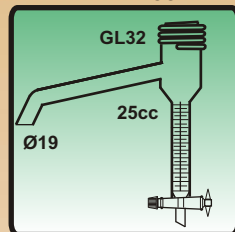

REAX-790

- REAX-785: Dessicator straight
- REAX-786: Dessicator bent
- REAX-787: Gas sampler 250cc
- REAX-788: Reagents flask 250cc for 2 tubes
- REAX-789: Separation flask
- REAX-790: Dean Stark
- REAX-791: Soxhlet extractor
- REAX-785: Dessicateur droit
- REAX-786: Dessicateur coudé
- REAX-787: Cylindre pour échantillons gas 250cc
- REAX-788: Flacon pour réactifs de 250cc
- REAX-789: Flacon de séparation
- REAX-790: Dean Stark
- REAX-791: Extracteur Soxhlet
- REAX-785: Dessecador recto
- REAX-786: Dessecador curvado
- REAX-787: Cilindro para amostras de gaz 250cc
- REAX-788: Frasco reagentes 250cc para 2 tubos
- REAX-789: Frasco de separação
- REAX-790: Dean Stark
- REAX-791: Extractor Soxhlet
- REAX-785: Desecador recto
- REAX-786: Desecador curvado
- REAX-787: Muestreador para gases 250cc
- REAX-788: Frasco para reactivos 250cc
- REAX-789: Frasco de separación
- REAX-790: Dean Stark
- REAX-791: Extractor Soxhlet

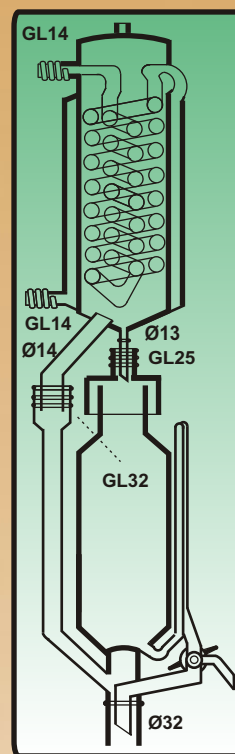

REAX-791

JUMPERS | JONCTIONS | UNIÕES | UNIONES

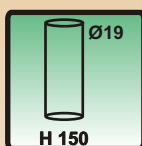

REAX-800

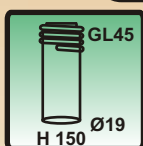

REAX-801



REAX-802

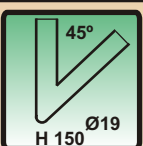

REAX-803

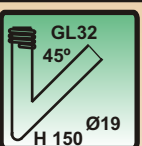

REAX-804



REAX-805

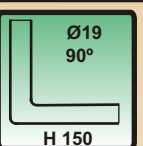

REAX-806

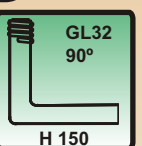

REAX-807

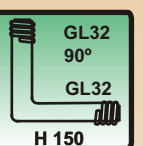

REAX-808

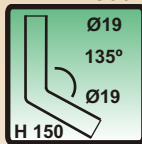

REAX-809

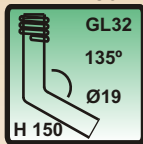

REAX-810



REAX-811

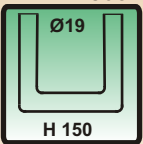

REAX-812



REAX-813

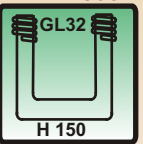

REAX-814

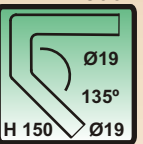

REAX-815



REAX-816

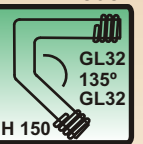

REAX-817

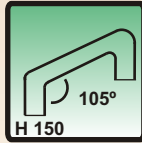

REAX-818



REAX-819

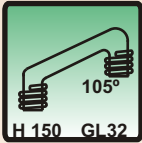

REAX-820

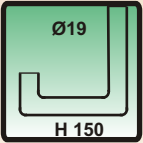

REAX-821

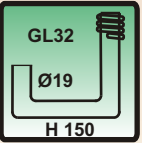

REAX-822

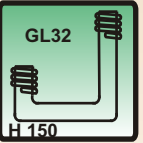

REAX-823



REAX-824

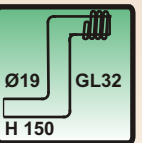

REAX-825

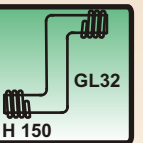

REAX-826

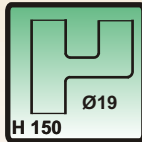

REAX-827

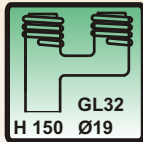

REAX-828

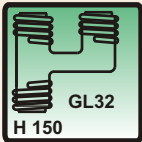

REAX-829

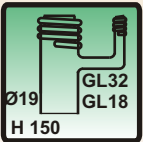

REAX-830

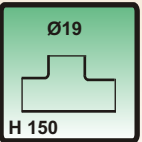

REAX-831



REAX-832

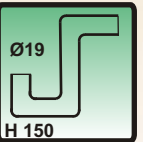

REAX-833

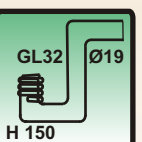

REAX-834

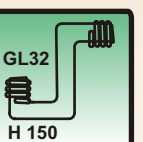

REAX-835

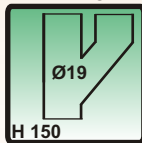

REAX-836



REAX-837

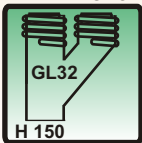

REAX-838

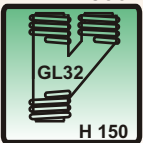

REAX-839



REAX-840



REAX-841

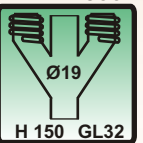

REAX-842

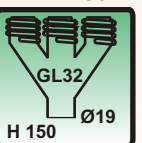

REAX-843

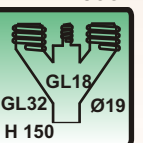

REAX-844



REAX-845



REAX-846



REAX-847



REAX-848

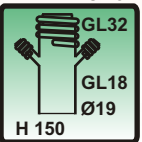

REAX-849

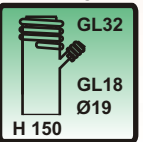

REAX-850

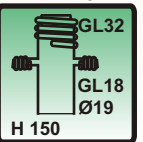

REAX-851

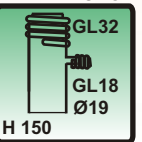

REAX-852

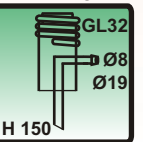

REAX-853





**CLIPS WITH BAR**

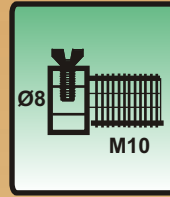
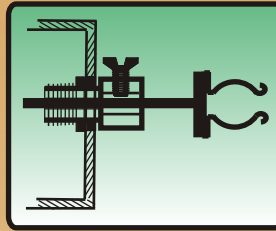

REAX-948

**CLIPS COM BARRA**



**CLIPS CON VARILLA**

**CLIPS AVEC TIGE**

- UK** Provided with fixing bars of Ø8x300mm length in stainless steel, or with metallic flexo. The clips are made of 3 different materials: A) Of plastic, to operate 60°C max. B) Of plastic coated steel, 60° Max. C) Of nickel coated steel, 300°C Max. In order to can hold the clips in the reactor housing M10 screwd holes, must be used the stainless steel holder REAX-948.
- FR** Munis avec tiges de Ø8x300mm longueur, en acier inox, ou avec flexo métallique. Les clips sont fabriqués en 3 matériels différents: A) En plastique pour travailler 60° max. B) En acier recouvert de plastique 60°C Max C) En acier nickelé 300°C max. Pour pouvoir fixer les clips aux trous visés M10 du boîtier du réacteur, il faut utiliser les adaptateurs d'acier inox REAX-948.
- PT** Providos de barras de Ø8x300mm comprido, fabricados em aço inox, ou com flexo metálico. Os clips estão fabricados em três materiais diferentes: A) Em plástico até 60°C max. B) Em aço plastificado, max.60°C. C) Aço revestido de níquel max 300°C. Para poder fixar os clips nos orifícios roscados M10 das paredes do chassi, deve usar-se o adaptador em aço inox REAX-948.
- ES** Provistos con una varilla de Ø8x300mm largo de acero inox o con un flexo metálico. Los clips pueden ser de 3 materiales diferentes: A) De plástico para trabajar hasta 60°C max. B) De acero plastificado, max 60°C. C) De acero niquelado, max 300°. Para poder fijar los clips en los agujeros roscados de M10 de las paredes del chasis, se necesita usar el adaptador REAX-948.

A) Max. 60°C		
UK PLASTIC	FR PLASTIQUE	PT PLASTICO
Standard	Flexo	ØMin
REAX-870	REAX-871	6.4
REAX-872	REAX-873	7.9
REAX-874	REAX-875	9.5
REAX-876	REAX-877	11.1
REAX-878	REAX-879	12.7
REAX-880	REAX-881	14.3
REAX-882	REAX-883	15.9
REAX-884	REAX-885	17.5
REAX-886	REAX-887	19.1
REAX-888	REAX-889	22.2
REAX-890	REAX-891	25.4
REAX-892	REAX-893	34.9
REAX-894	REAX-895	38.1
REAX-896	REAX-897	57.4

B) Max. 60°C		
UK PLASTIFIED STEEL	FR ACIER PLASTIFIÉ	PT AÇO PLASTIFICADO
Standard	Flexo	ØMin
REAX-900	REAX-901	6.4
REAX-902	REAX-903	9.5
REAX-904	REAX-905	12.7
REAX-906	REAX-907	15.9
REAX-908	REAX-909	12.7
REAX-910	REAX-911	15.9
REAX-912	REAX-913	19.0
REAX-914	REAX-915	25.4
REAX-916	REAX-917	28.6
REAX-918	REAX-919	31.7
REAX-920	REAX-921	38.1

C) Max. 300°C			
UK Steel+Nickel	FR Acier+Nickel	PT Aço+níquel	ES Acero+Níquel
Standard	Flexo	ØMin	ØMax
REAX-922	REAX-923	4	5
REAX-924	REAX-925	6	7
REAX-926	REAX-927	8	9
REAX-928	REAX-929	10	11
REAX-930	REAX-931	12	13
REAX-932	REAX-933	14	15
REAX-934	REAX-935	16	17
REAX-936	REAX-937	18	19
REAX-938	REAX-939	20	21
REAX-940	REAX-941	22	23
REAX-942	REAX-943	24	25
REAX-944	REAX-945	27	30
REAX-946	REAX-947	32	35



**STAINLESS STEEL NUTS**

REAX-948

**NOIX EN ACIER INOX**

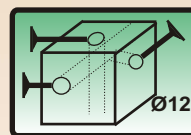
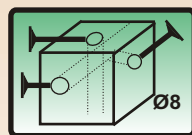

**GRAMPOS AÇO INOX**

REAX-949

**NUECES ACERO INOX**

**STAINLESS STEEL BARS**

**TIGES EN ACIER INOX**

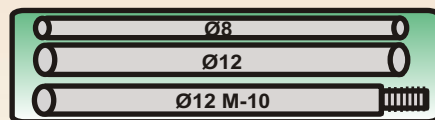

**BARRAS EM AÇO INOX**

**VARILLAS ACERO INOX**

Ø	50mm L	100mm L	150mm L	200mm L	300mm L	400mm L	500mm L
8mm	REAX-950	REAX-951	REAX-952	REAX-953	REAX-954	REAX-955	REAX-956
12mm	REAX-957	REAX-958	REAX-959	REAX-960	REAX-961	REAX-962	REAX-963
12mm Screw/Visé/Rosca M10	REAX-964	REAX-965	REAX-966	REAX-967	REAX-968	REAX-969	REAX-970

**STAINLESS St SUPPORTS**

**SUPPORTS ACIER INOX**

REAX-971: Ø 4-6-8-10-12 REAX-972: Ø14-19-32-40-44-50 REAX-973: Ø70 REAX-974: Ø80 REAX-975: Ø90 REAX-976: Ø100

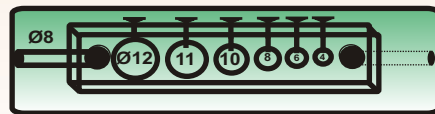

**SUPORTES AÇO INOX**

**SOPORTES ACERO INOX**

**STAINLESS ST. CLAMP**

**PINCE EN ACIER INOX**



**PINÇA EM AÇO INOX**

**PINZA DE ACERO INOX**

**UK** Arms with plastic coating **FR** Pales plastifiées **PT** Garras plastificadas **ES** Palas plastificadas





MAGNETIC STIRRING AGITATION MAGNETIQUE AGITAÇÃO MAGNÉTICA AGITACION MAGNETICA

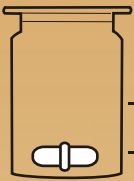

REAX-101/102/103/104/105

REAX-122/3

- REAX-122/0 Ø6x20
- REAX-122/3 Ø8x40
- REAX-122/1 Ø12
- REAX-122/2 Ø16
- REAX-123/1 Ø10x20
- REAX-123/2

REAX-106/107/108/109/110/111

REAX-132/2

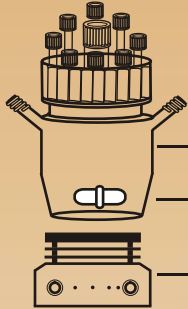
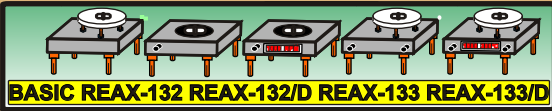
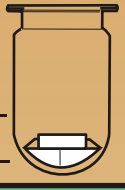

REAX-118

REAX-122/0

BASIC

Or REAX-129  
REAX-131

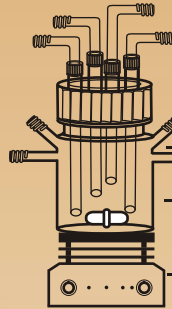

REAX-119

REAX-122/0

BASIC

Or REAX-129  
REAX-131

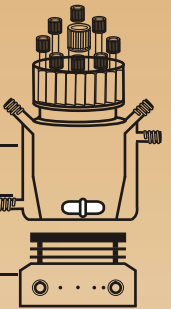

REAX-120

REAX-122/0

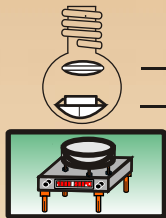

REAX-600/601/602

REAX-123/1

REAX-603/604/605

REAX-123/2

REAX-133/DO

REAX-123/1

REAX-607/608/609

REAX-123/2

REAX-610

REAX-133/DO

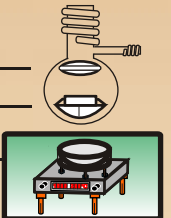

REAX-600  
REAX-601  
REAX-602  
REAX-603  
REAX-604  
REAX-605

REAX-607  
REAX-608  
REAX-609  
REAX-610

REAX-630  
REAX-631  
REAX-632  
REAX-633

REAX-637  
REAX-638  
REAX-639  
REAX-640

REAX-645  
REAX-646  
REAX-647  
REAX-648

REAX-652  
REAX-653  
REAX-654  
REAX-655

REAX-660  
REAX-661  
REAX-662  
REAX-663

REAX-667  
REAX-668  
REAX-669  
REAX-670

REAX-675  
REAX-676  
REAX-677  
REAX-678

REAX-682  
REAX-683  
REAX-684  
REAX-685

REAX-122/3

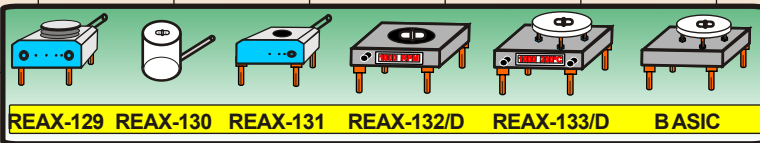
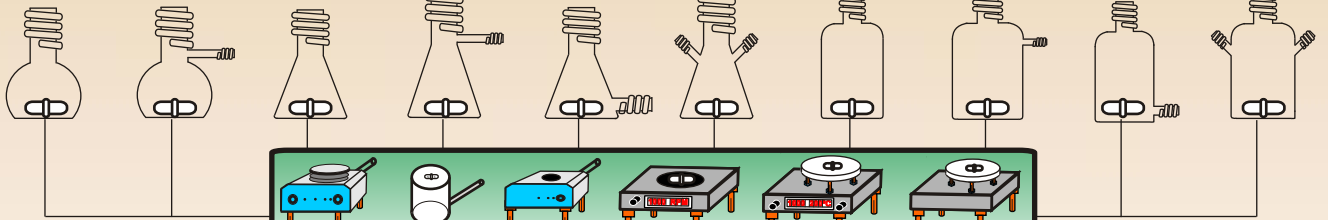

REAX-728  
REAX-729  
REAX-730  
REAX-731  
REAX-732

REAX-736  
REAX-737  
REAX-738  
REAX-739  
REAX-740

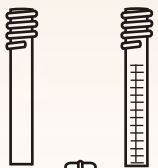

REAX-122/0

REAX-130

REAX-690  
REAX-691  
REAX-692  
REAX-693  
REAX-697

REAX-700  
REAX-701  
REAX-708  
REAX-709  
REAX-715

REAX-715  
REAX-722  
REAX-723

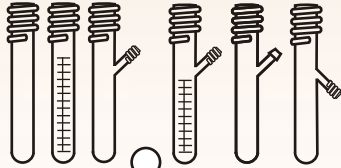

REAX-122/1

REAX-130

REAX-694  
REAX-695  
REAX-698  
REAX-702  
REAX-703

REAX-704  
REAX-710  
REAX-711  
REAX-712  
REAX-716

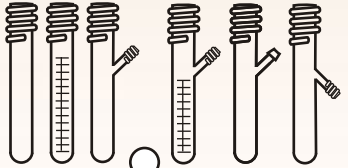

REAX-122/2

REAX-130







STIRRING AGITATION AGITAÇÃO AGITACION

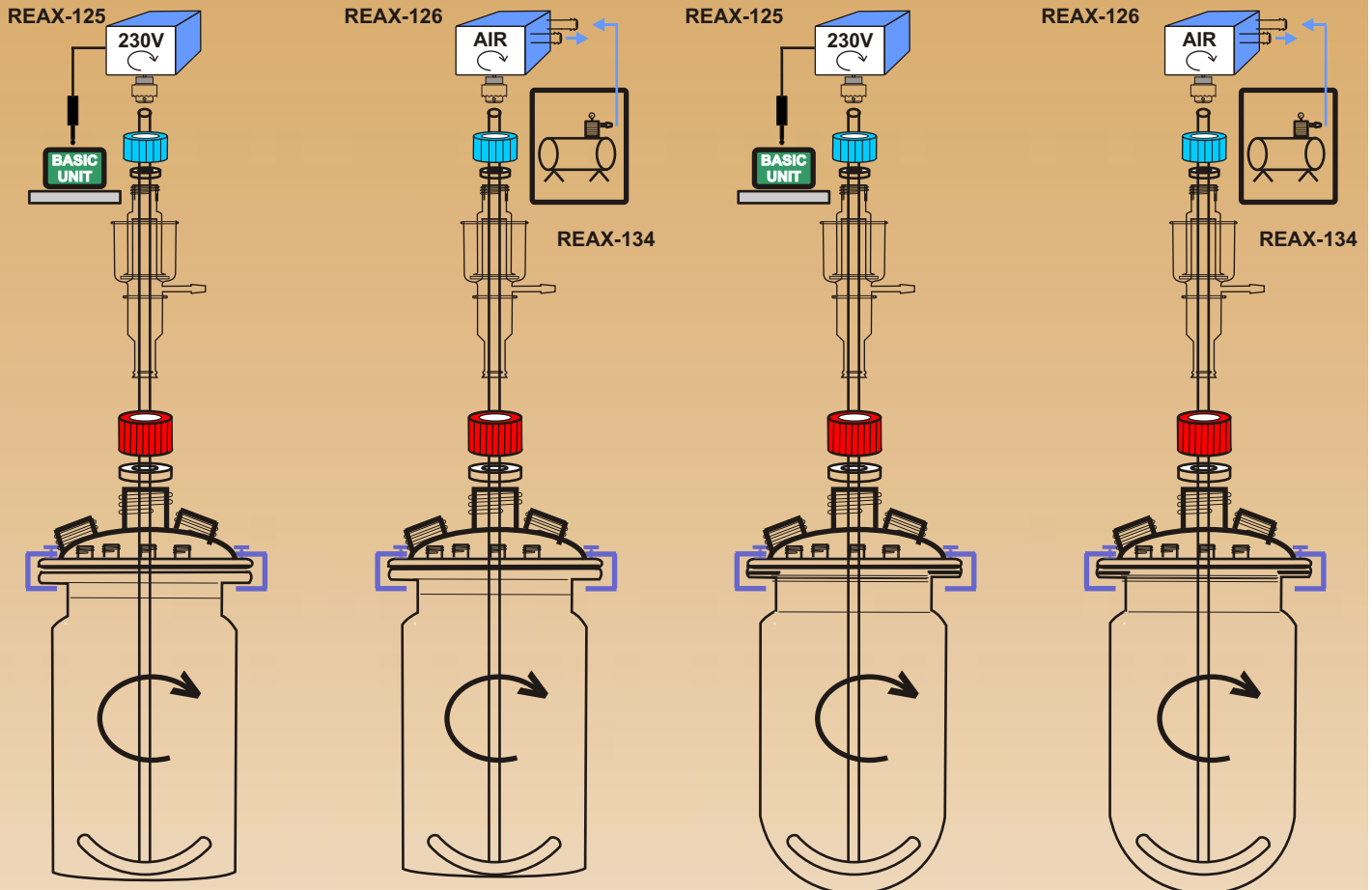

Glass Verre Vidrio Vidrio h 523 Ø100	PTFE h 523 Ø100	S.Steel Inox h 523 Ø100	S.Steel Inox h 523 Ø100	S.Steel Inox h 523 Ø100	S.Steel Inox h 523 Ø40	S.Steel Inox h 523 Ø60	S.Steel Inox h 523 Ø80	S.Steel Inox h 523 Ø100
REAX-137	REAX-138	REAX-139	REAX-140	REAX-141	REAX-142	REAX-143	REAX-144	REAX-145

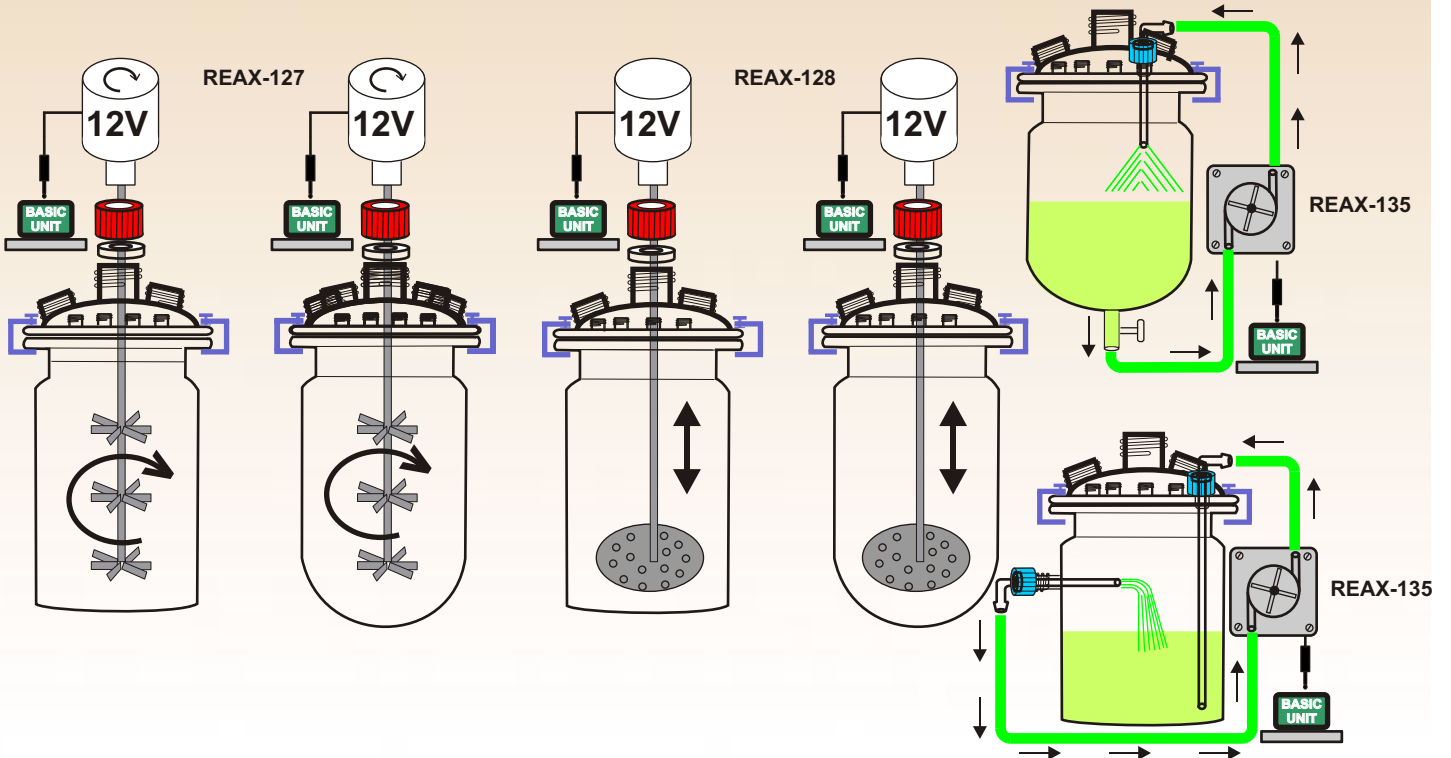



☒ THERMOSTATIZATION ☐ THERMOSTATISATION ☐ TERMOSTATIZAÇÃO ☐ TERMOSTATIZACION

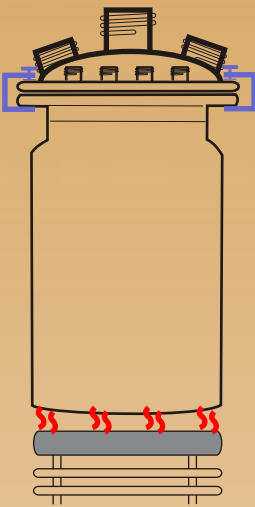

BASIC UNIT

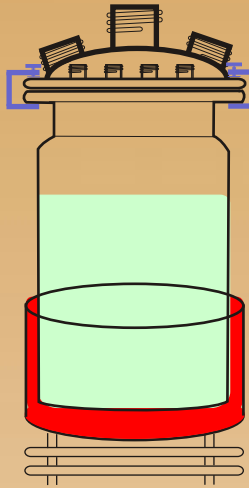

REAX-153

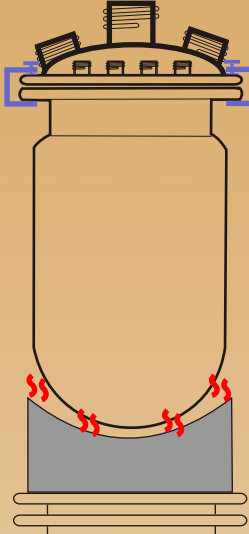

REAX-150 REAX-151

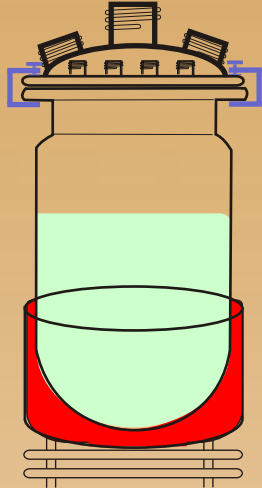

REAX-153

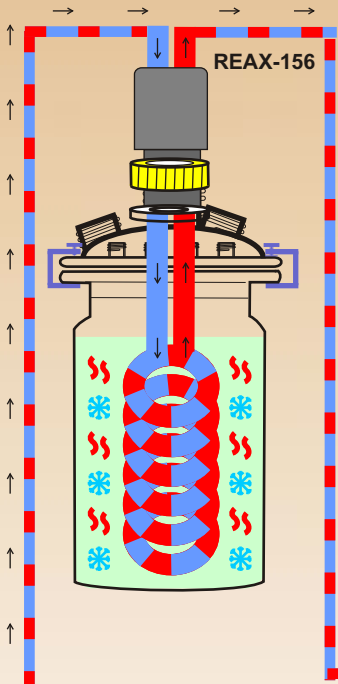

REAX-156

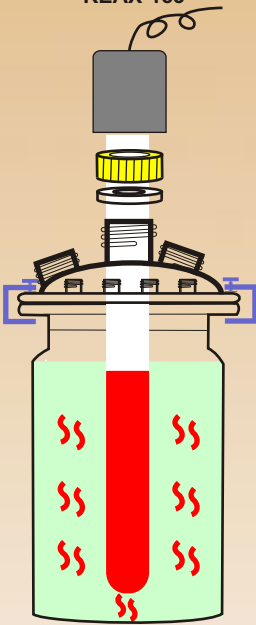

REAX-154

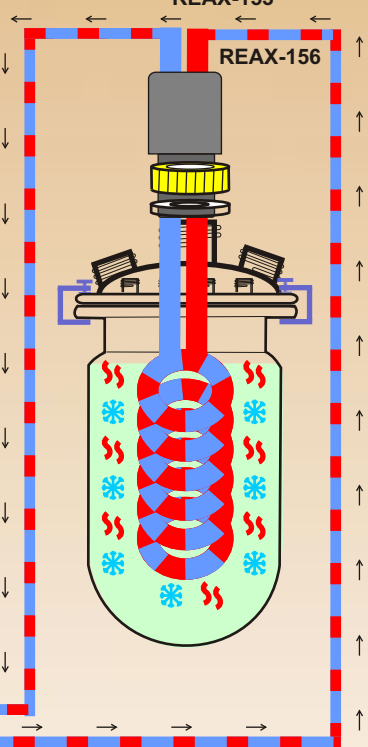
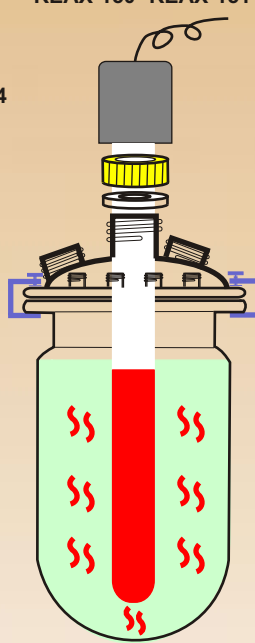

REAX-156



REAX-157

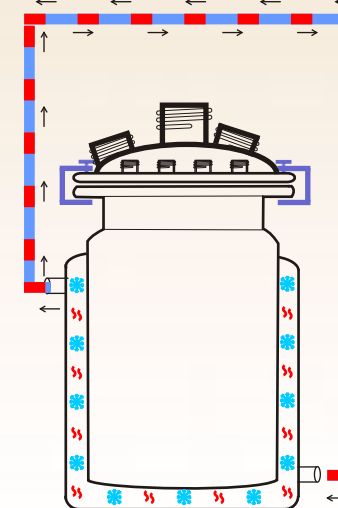

REAX-157 REAX-158

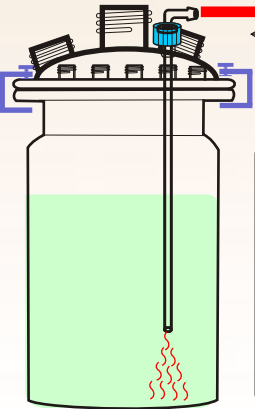

REAX-162

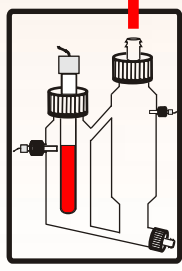

REAX-162

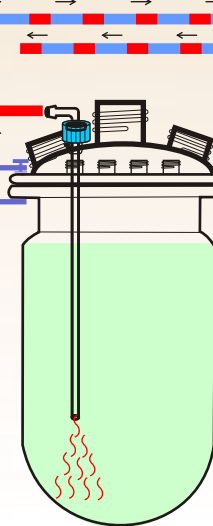



UV STERILIZATION STERILIZATION A UV ESTERILIZAÇÃO A UV ESTERILIZACION A UV

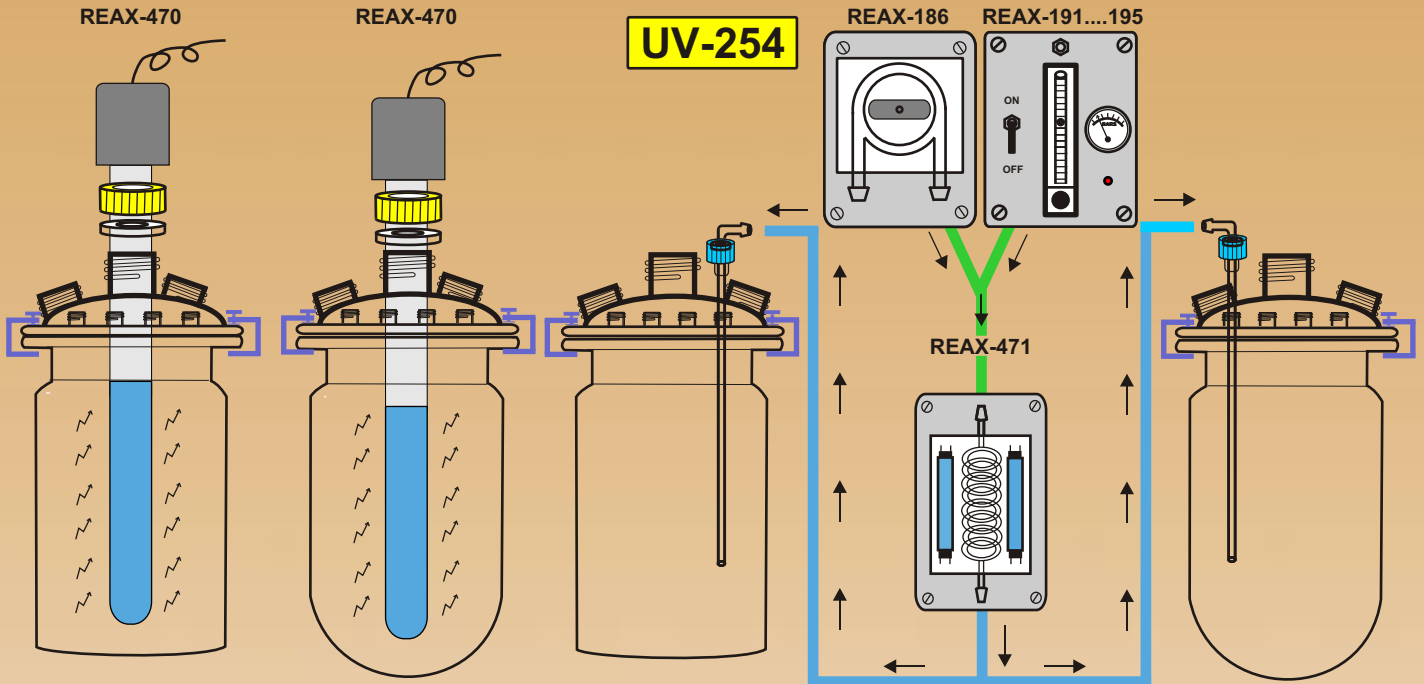

IRRADIATION IRRADIATION IRRADIAÇÃO IRRADIACION

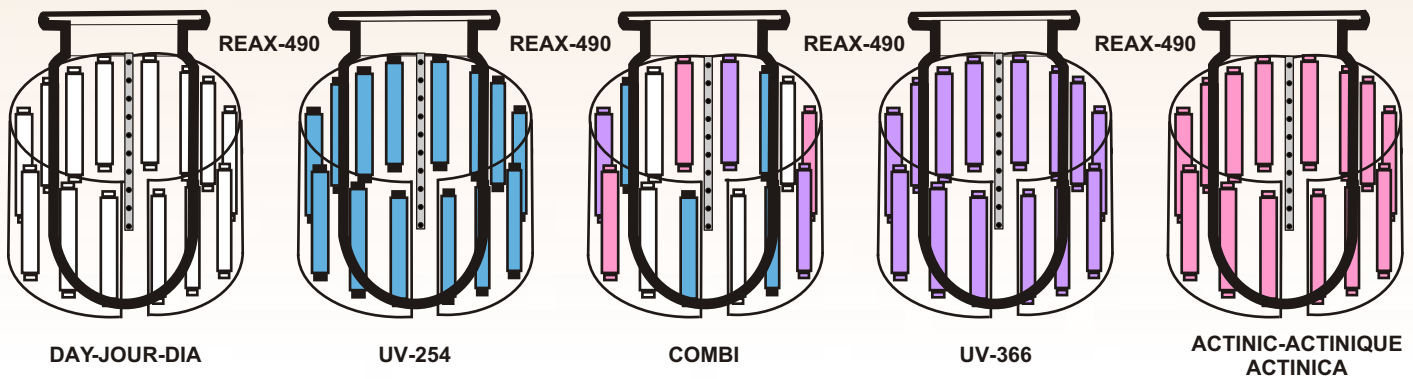
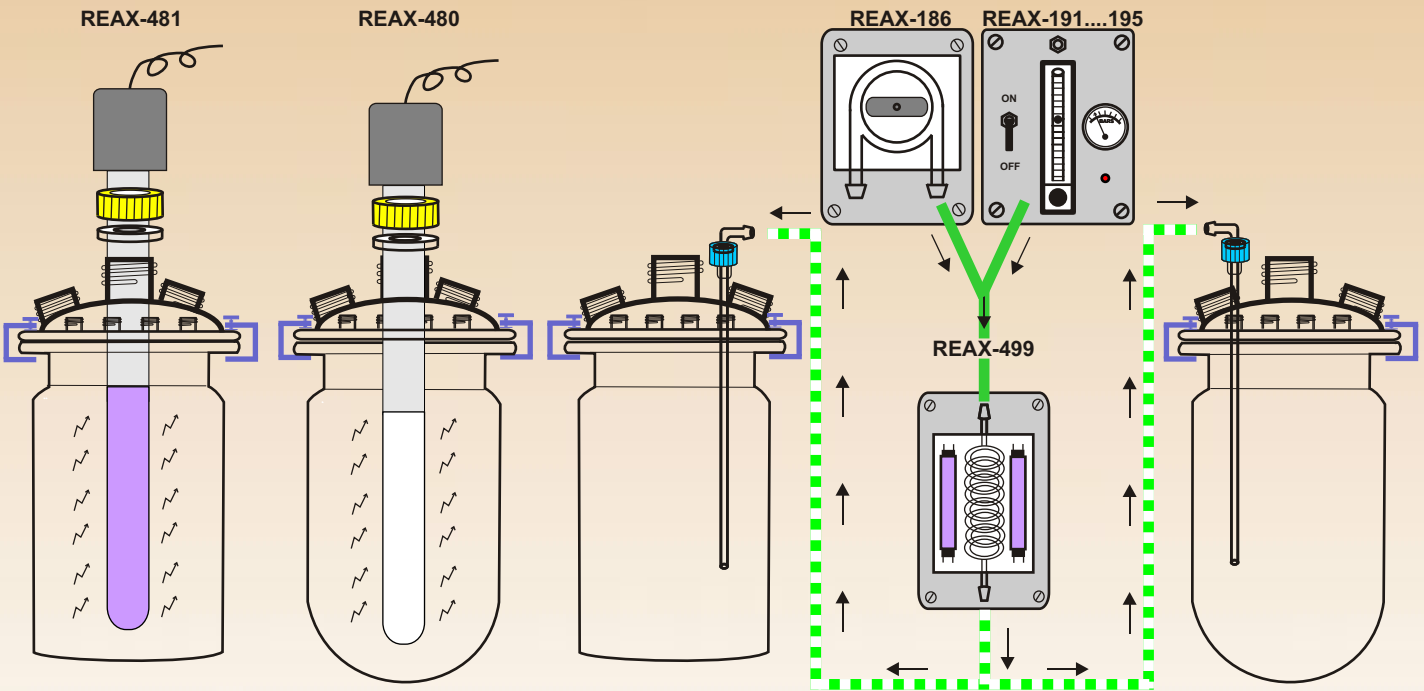



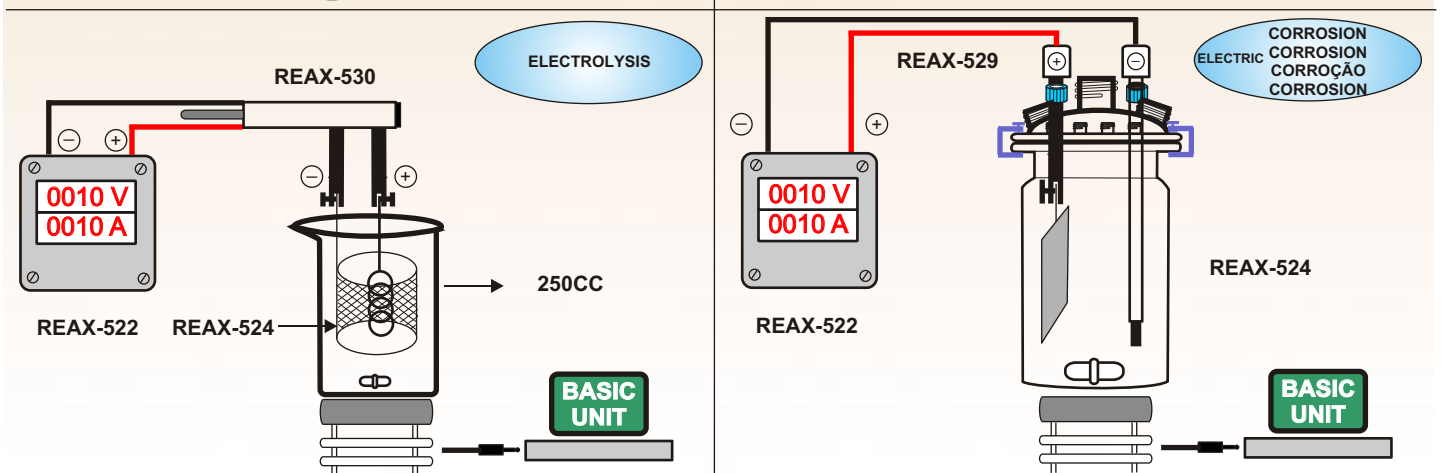
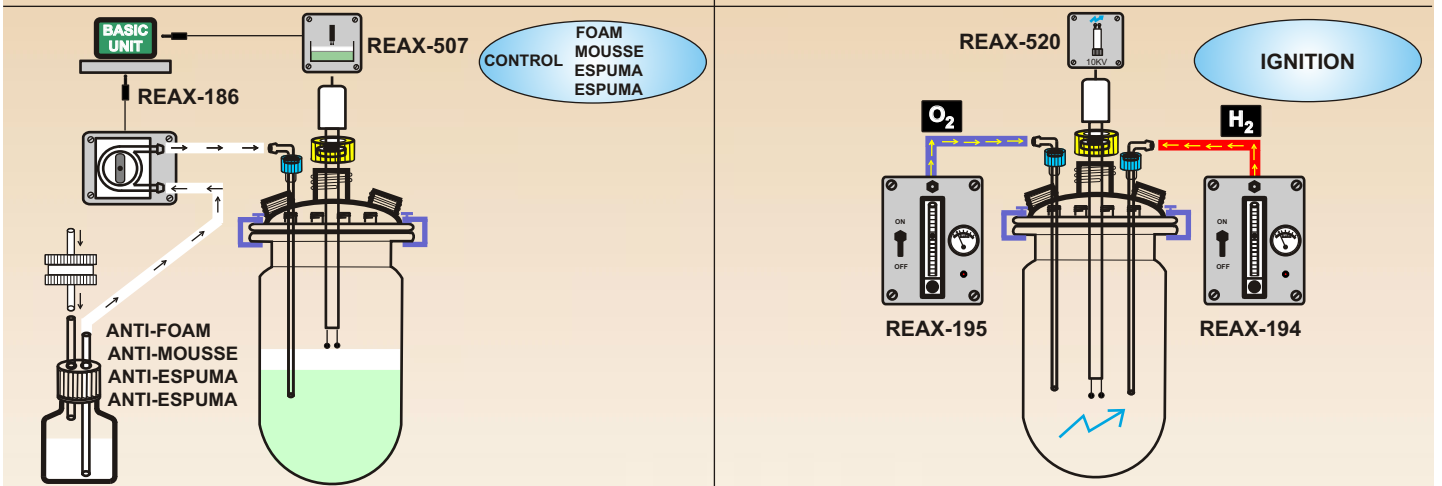
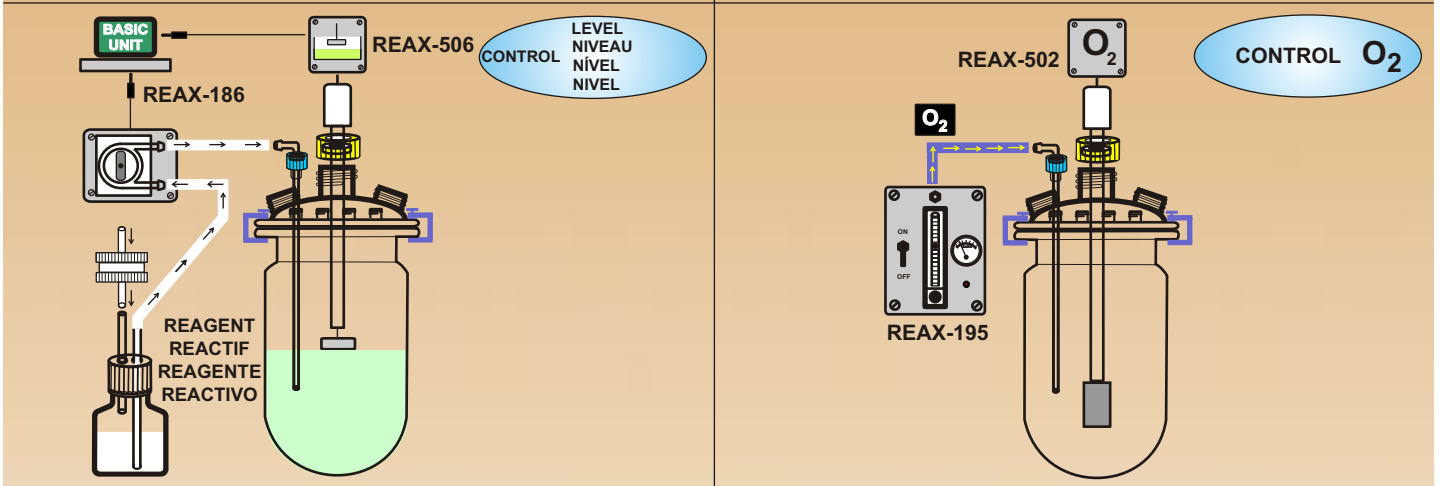
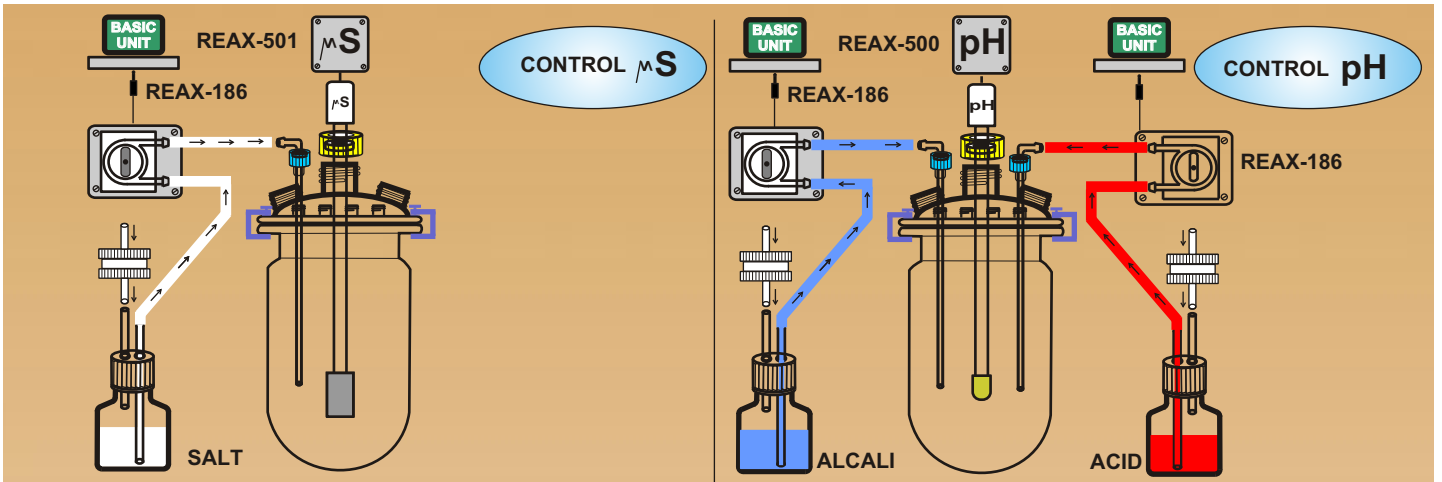



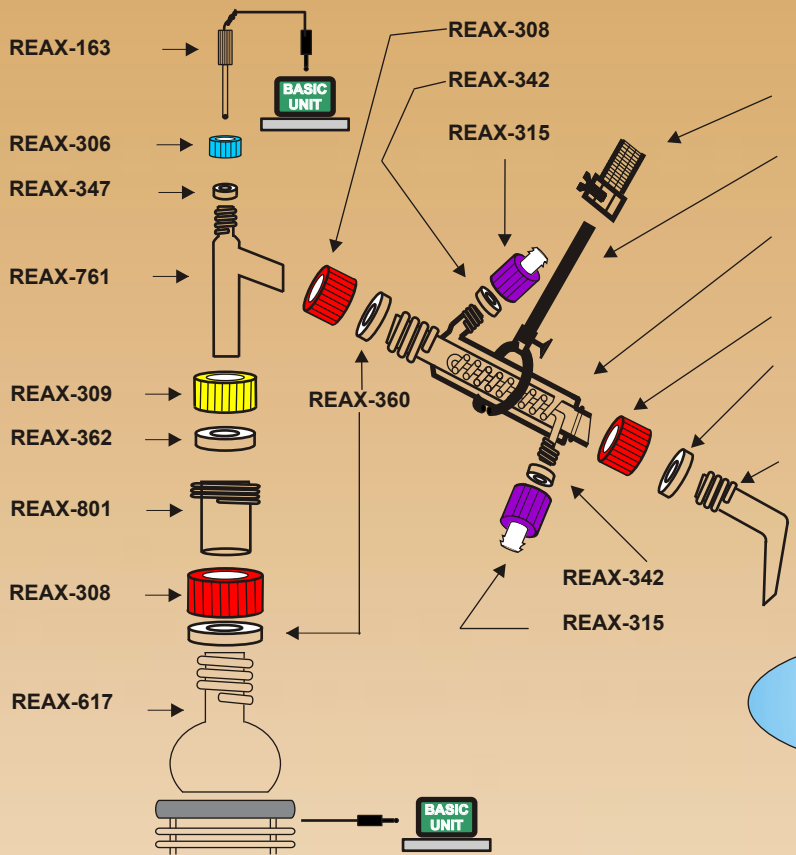

 SIMPLE DISTILLATION 
  DISTILLATION SIMPLE 
  DESTILAÇÃO SIMPLE 
  DESTILACION SIMPLE



Ref COMPLET KIT  
REAX-2100



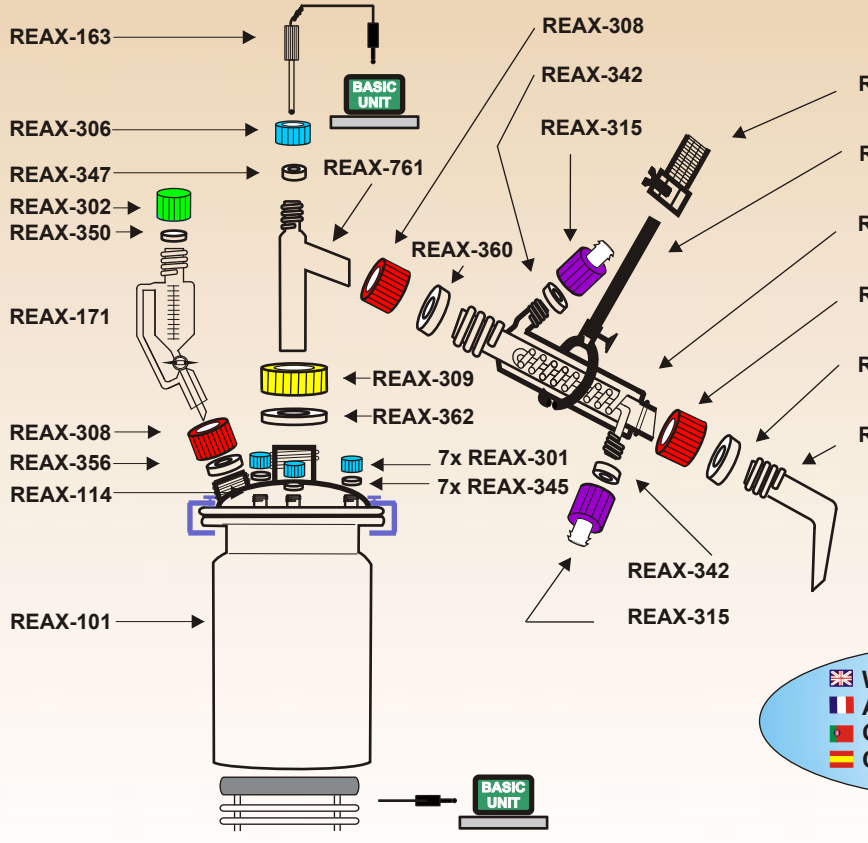

- 1X REAX-163
- 1X REAX-306
- 3X REAX-308
- 1X REAX-309
- 2X REAX-315
- 2X REAX-342
- 1X REAX-347
- 3X REAX-360
- 1X REAX-362
- 1X REAX-617
- 1X REAX-770
- 1X REAX-775
- 1X REAX-801
- 1X REAX-948
- 1X REAX-997

 WITH BALOON  
 AVEC BALLON  
 COM BALÃO  
 CON MATRAZ BALON



Ref COMPLET KIT  
REAX-2101

- 1X REAX-101
- 1X REAX-114
- 1X REAX-163
- 1X REAX-171
- 7X REAX-301
- 1X REAX-302
- 1X REAX-306
- 2X REAX-308
- 1X REAX-309
- 2X REAX-315
- 2X REAX-342
- 7X REAX-345
- 1X REAX-347
- 1X REAX-350
- 2X REAX-360
- 1X REAX-362
- 1X REAX-770
- 1X REAX-775
- 1X REAX-948
- 1X REAX-997

 WITH FLAT REACTOR  
 AVEC REACTEUR PLAIN  
 COM REACTOR PLANO  
 CON REACTOR PLANO

 Regulation included in the Basic Unit REAX-2000  
 Régulation incorporé dans l'Unitée Basique REAX-2000  
 Regulação incorporada na Unidade Basica REAX-2000  
 Regulación incluida en la Unidad Básica REAX-2000





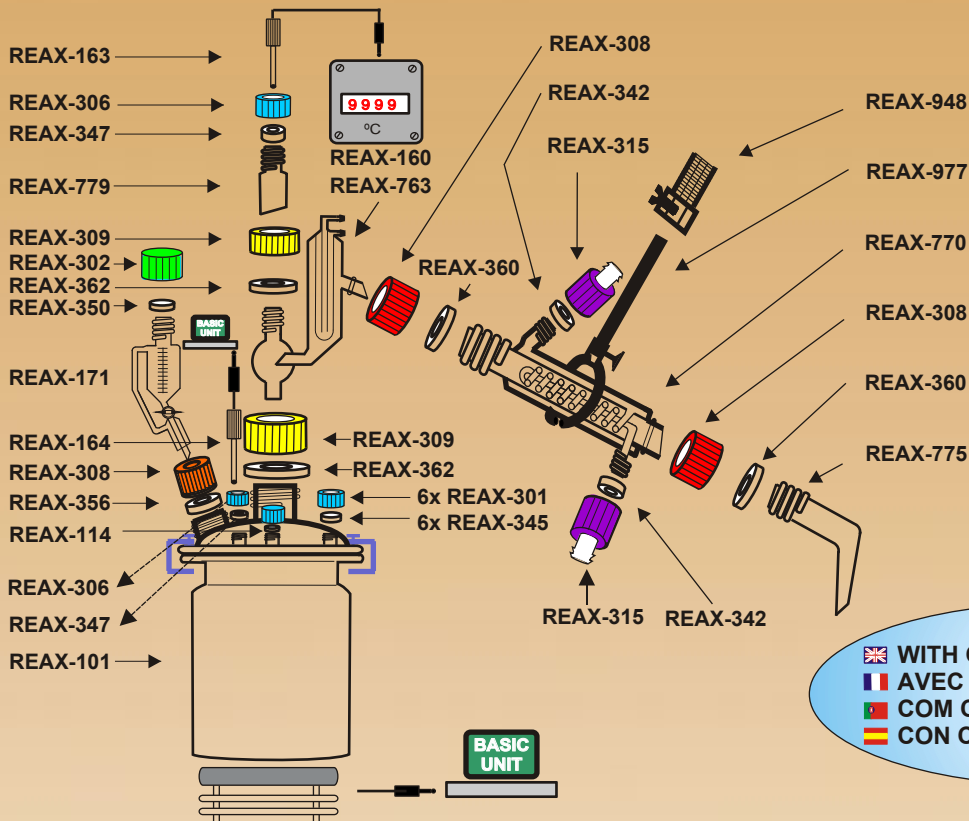

 SIMPLE DISTILLATION 
  DISTILLATION SIMPLE 
  DESTILAÇÃO SIMPLE 
  DESTILACION SIMPLE



Ref COMPLET KIT  
REAX-2102



1X REAX-101	6X REAX-345
1X REAX-114	2X REAX-347
1X REAX-160	1X REAX-350
1X REAX-163	1X REAX-356
1X REAX-164	2X REAX-360
6X REAX-301	1X REAX-763
1X REAX-302	1X REAX-770
2X REAX-306	1X REAX-775
3X REAX-308	1X REAX-779
2X REAX-309	1X REAX-948
2X REAX-315	1X REAX-997
2X REAX-342	

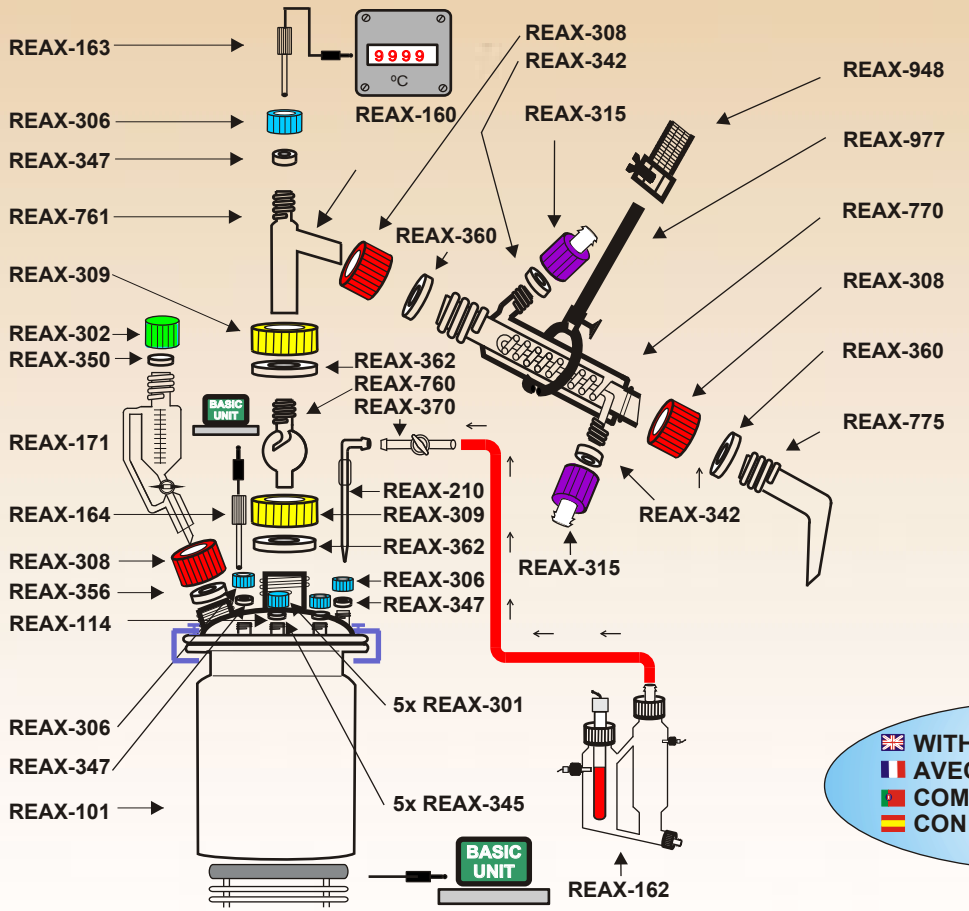



 WITH COOL FINGER HEAD  
 AVEC TETE AVEC FROID  
 COM CABEÇA COM DEDO FRIO  
 CON CABEZAL CON DEDO FRIO



Ref COMPLET KIT  
REAX-2103

1X REAX-101	2X REAX-342
1X REAX-114	5X REAX-345
1X REAX-160	3X REAX-347
1X REAX-162	1X REAX-350
1X REAX-163	1X REAX-356
1X REAX-164	2X REAX-360
1X REAX-171	2X REAX-362
1X REAX-210	1X REAX-370
5X REAX-301	1X REAX-760
1X REAX-302	1X REAX-761
3X REAX-306	1X REAX-770
3X REAX-308	1X REAX-775
2X REAX-309	1X REAX-948
2X REAX-315	1X REAX-997

 WITH STEAM  
 AVEC VAPEUR  
 COM VAPOR  
 CON ARRASTRE DE VAPOR

 Regulation included in the Basic Unit REAX-2000  
 Régulation incorporé dans l'Unitée Basique REAX-2000  
 Regulação incorporada na Unidade Basica REAX-2000  
 Regulación incluida en la Unidad Básica REAX-2000





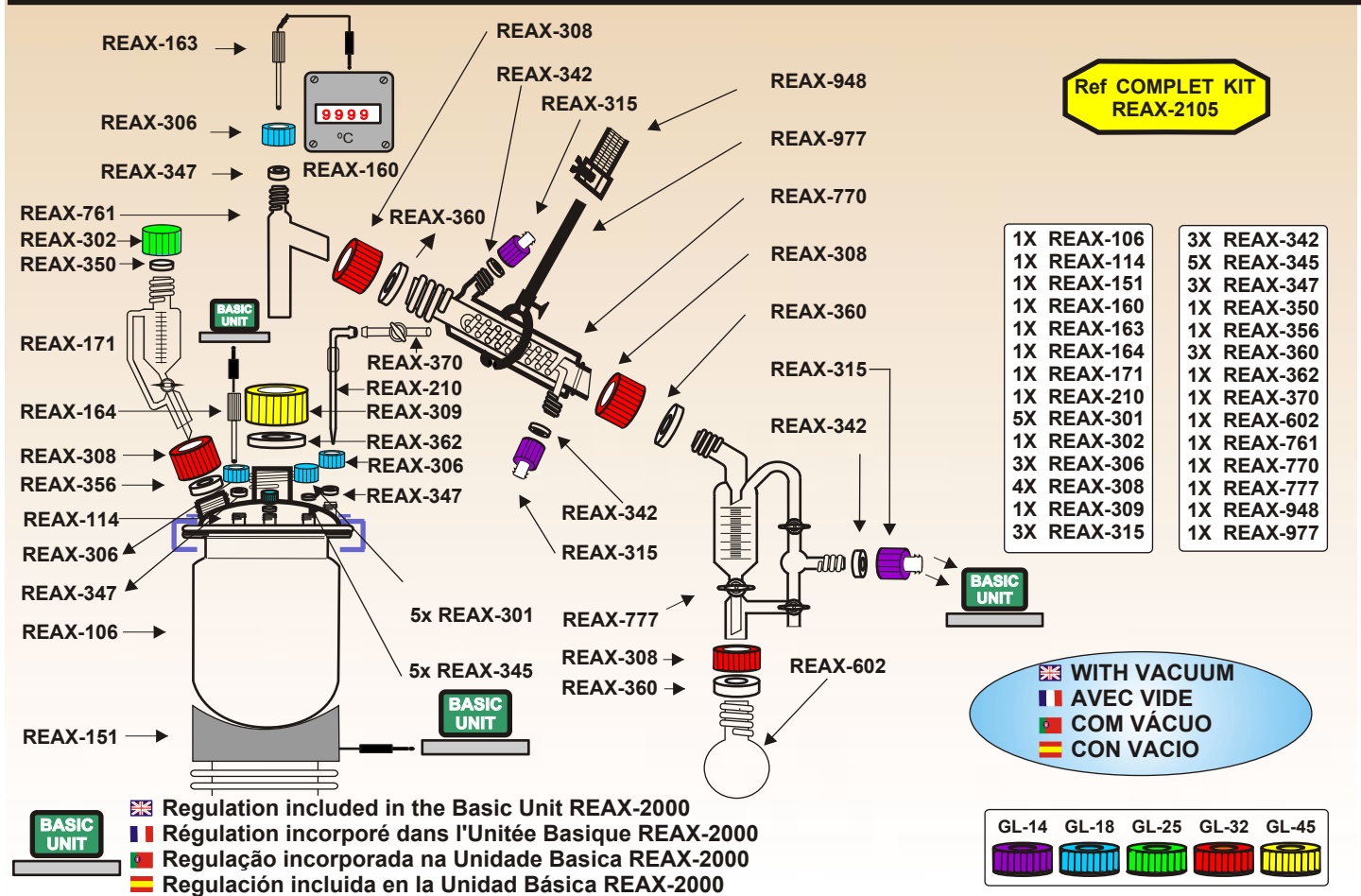
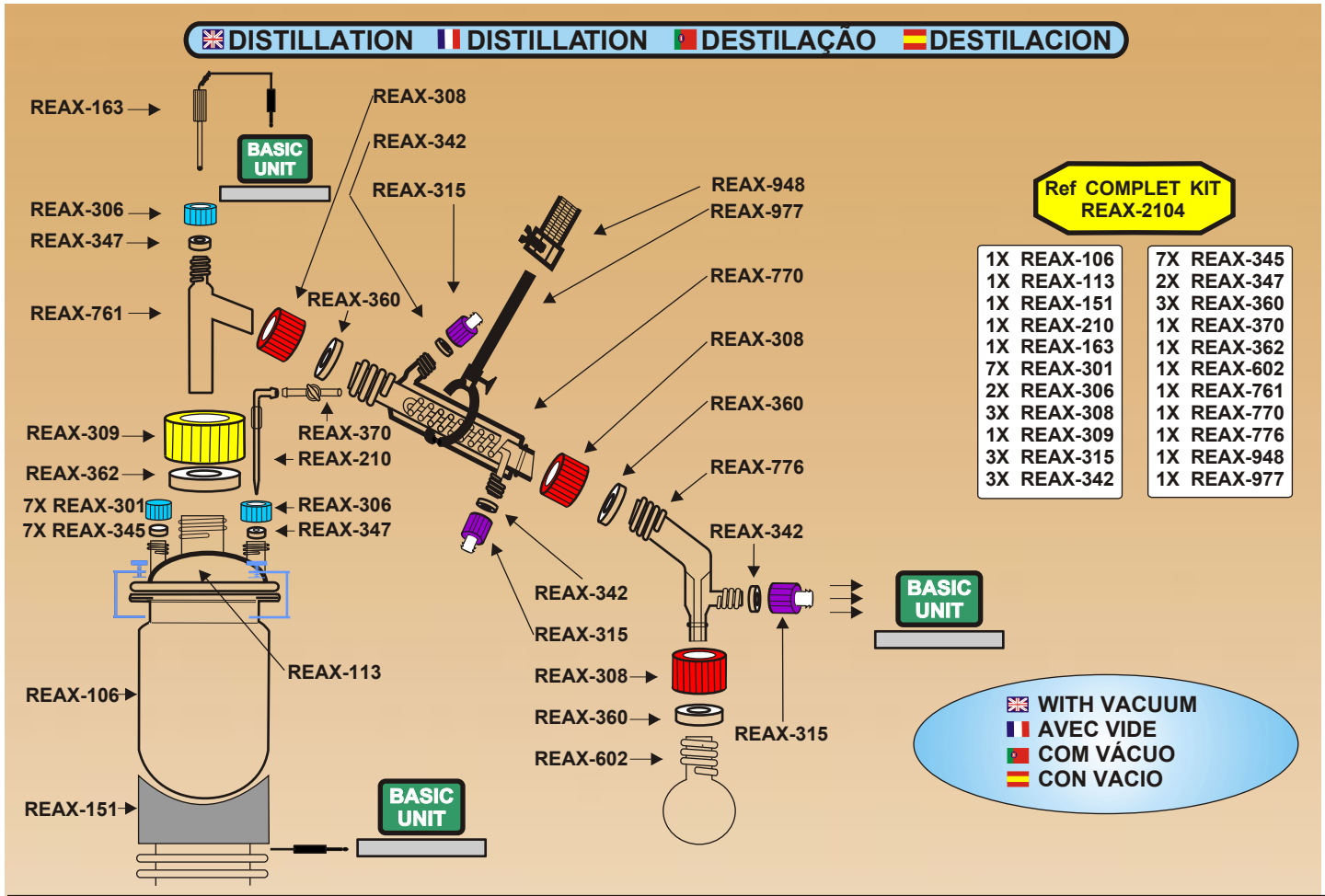



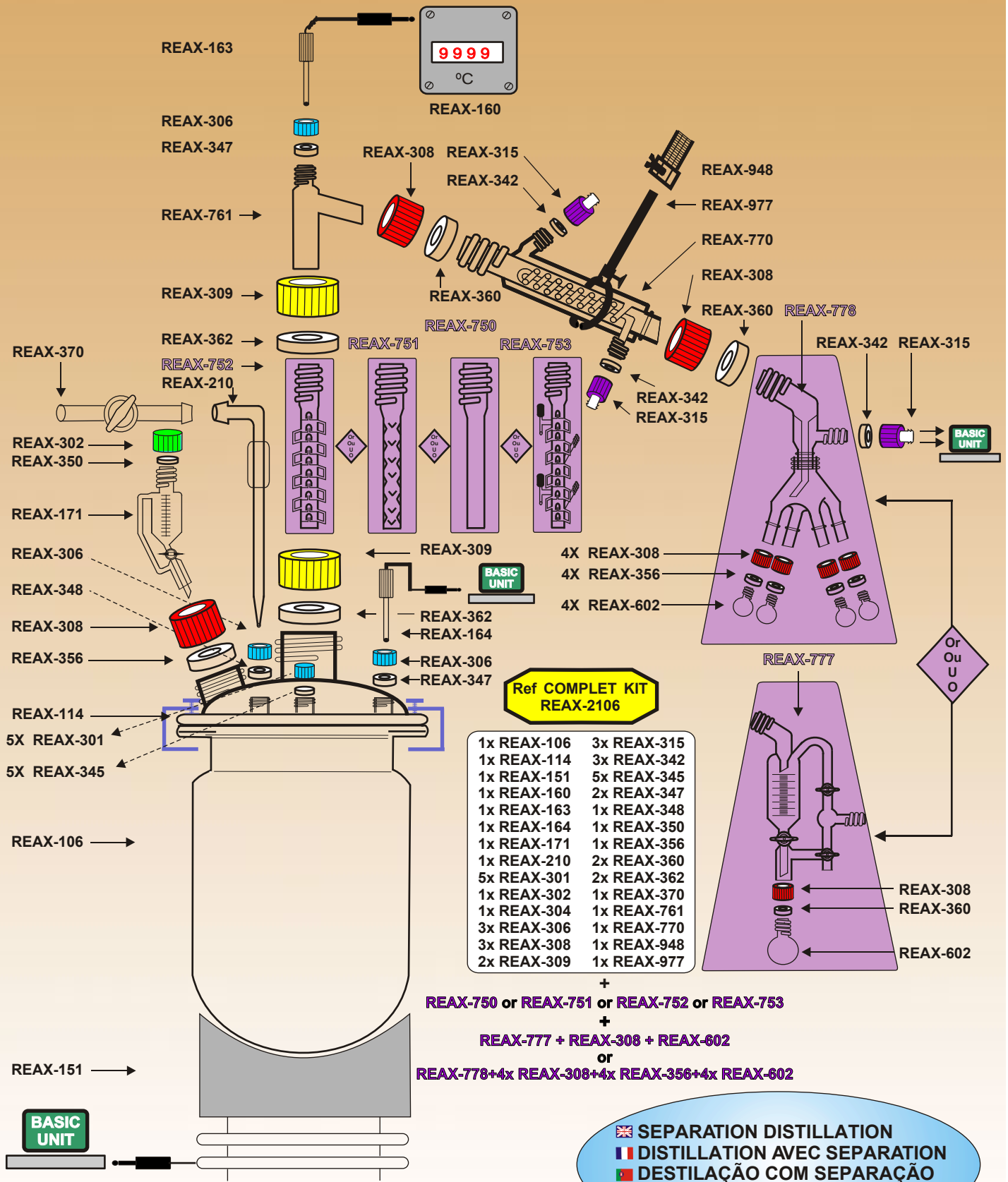

 DISTILLATION 
  DISTILLATION 
  DESTILAÇÃO 
  DESTILACION







**Ref COMPLET KIT REAX-2106**

- |             |             |
|-------------|-------------|
| 1x REAX-106 | 3x REAX-315 |
| 1x REAX-114 | 3x REAX-342 |
| 1x REAX-151 | 5x REAX-345 |
| 1x REAX-160 | 2x REAX-347 |
| 1x REAX-163 | 1x REAX-348 |
| 1x REAX-164 | 1x REAX-350 |
| 1x REAX-171 | 1x REAX-356 |
| 1x REAX-210 | 2x REAX-360 |
| 5x REAX-301 | 2x REAX-362 |
| 1x REAX-302 | 1x REAX-370 |
| 1x REAX-304 | 1x REAX-761 |
| 3x REAX-306 | 1x REAX-770 |
| 3x REAX-308 | 1x REAX-948 |
| 2x REAX-309 | 1x REAX-977 |

+ REAX-750 or REAX-751 or REAX-752 or REAX-753  
 + REAX-777 + REAX-308 + REAX-602  
 or REAX-778+4x REAX-308+4x REAX-356+4x REAX-602

 SEPARATION DISTILLATION  
 DISTILLATION AVEC SEPARATION  
 DESTILAÇÃO COM SEPARAÇÃO  
 DESTILACION CON SEPARACION

 Regulation included in the Basic Unit REAX-2000  
 Régulation incorporé dans l'Unitée Basique REAX-2000  
 Regulação incorporada na Unidade Basica REAX-2000  
 Regulación incluida en la Unidad Básica REAX-2000









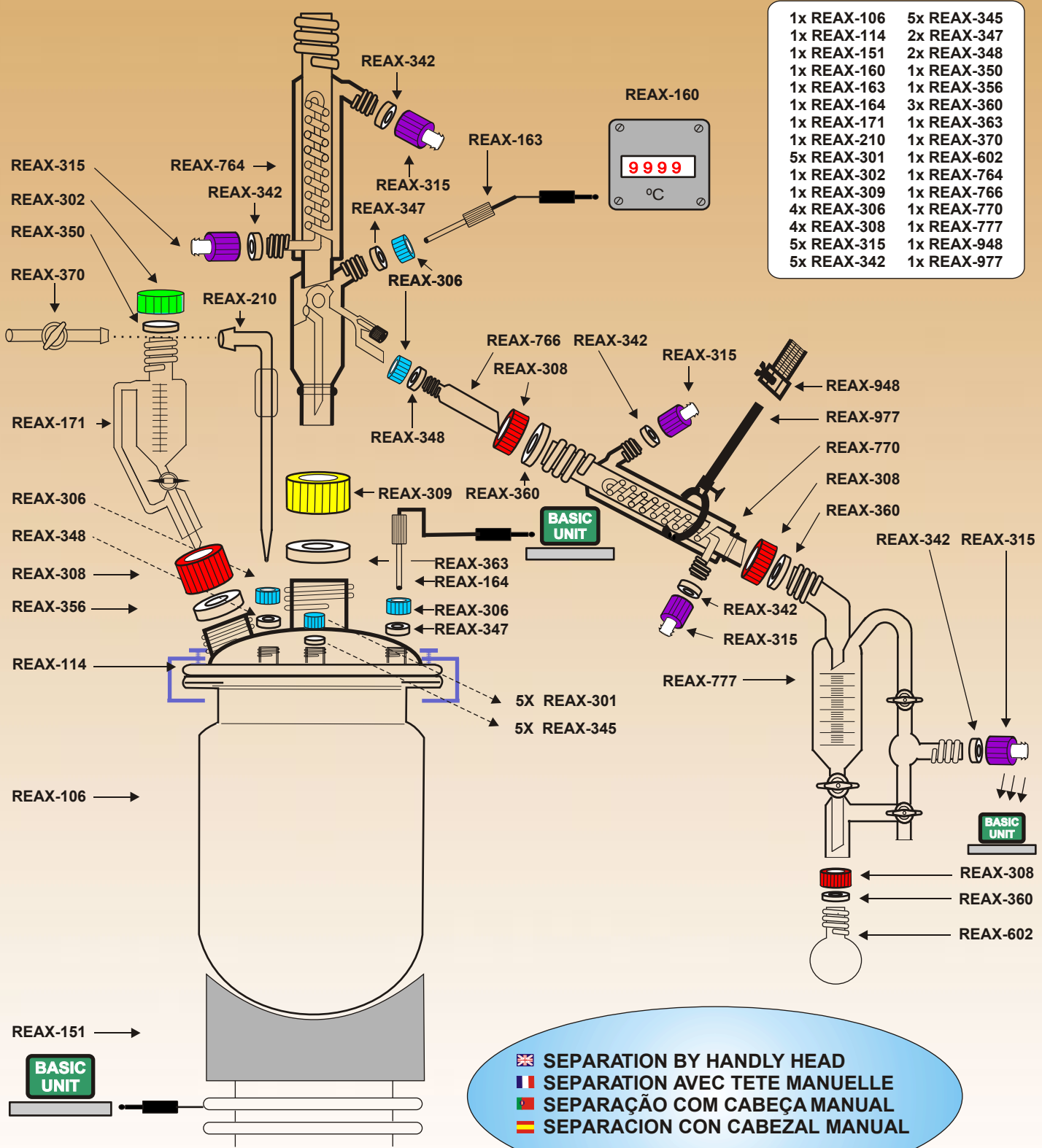

 DISTILLATION  
  DISTILLATION  
  DESTILAÇÃO  
  DESTILACION

Ref **COMPLET KIT**  
REAX-2107

1x REAX-106	5x REAX-345
1x REAX-114	2x REAX-347
1x REAX-151	2x REAX-348
1x REAX-160	1x REAX-350
1x REAX-163	1x REAX-356
1x REAX-164	3x REAX-360
1x REAX-171	1x REAX-363
1x REAX-210	1x REAX-370
5x REAX-301	1x REAX-602
1x REAX-302	1x REAX-764
1x REAX-309	1x REAX-766
4x REAX-306	1x REAX-770
4x REAX-308	1x REAX-777
5x REAX-315	1x REAX-948
5x REAX-342	1x REAX-977



 SEPARATION BY HANDLY HEAD  
 SEPARATION AVEC TETE MANUELLE  
 SEPARAÇÃO COM CABEÇA MANUAL  
 SEPARACION CON CABEZAL MANUAL

 Regulation included in the Basic Unit REAX-2000  
 Régulation incorporé dans l'Unité Basique REAX-2000  
 Regulação incorporada na Unidade Basica REAX-2000  
 Regulación incluida en la Unidad Básica REAX-2000

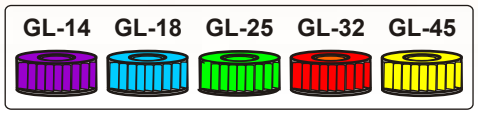









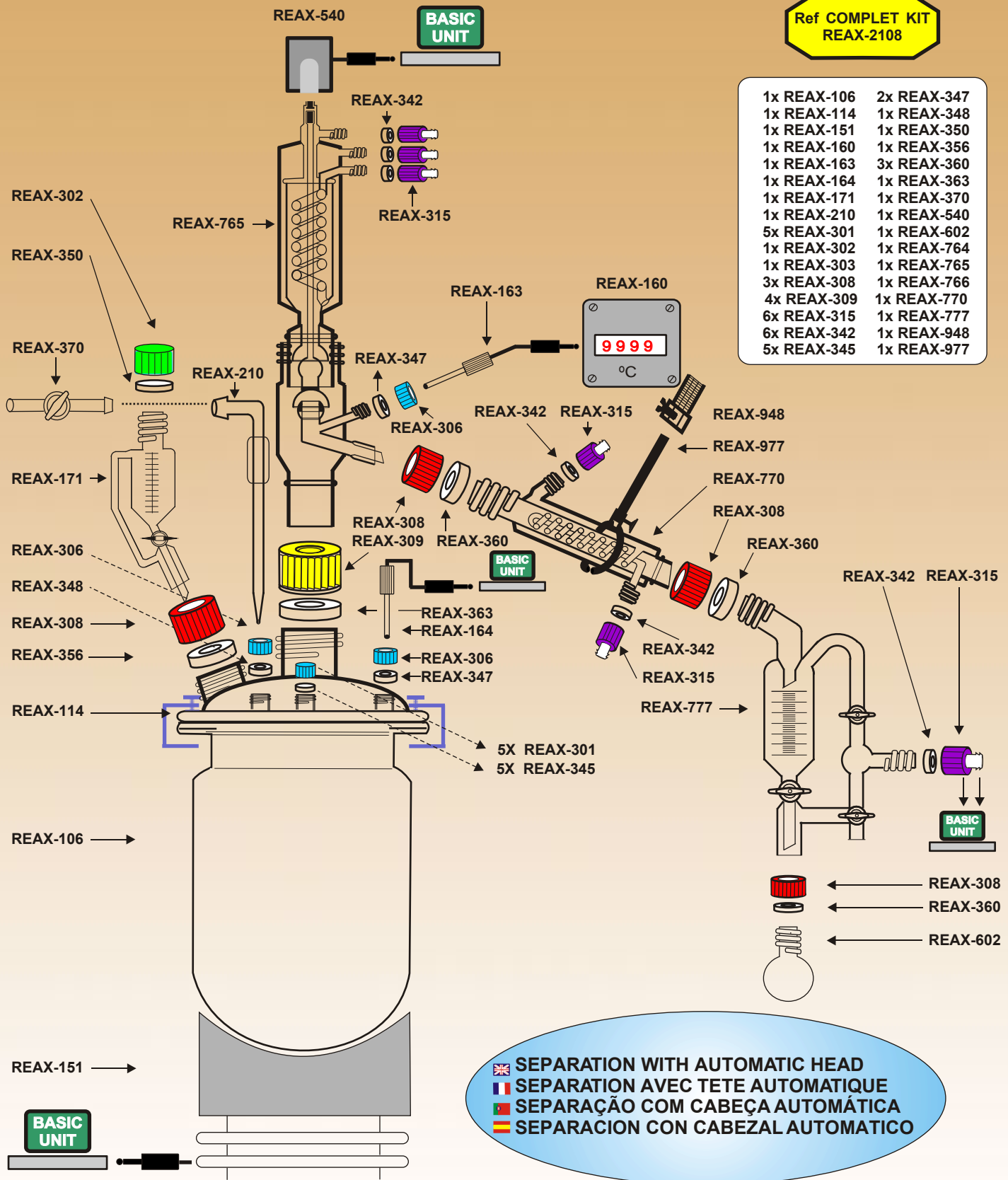

 DISTILLATION 
  DISTILLATION 
  DESTILAÇÃO 
  DESTILACION

Ref COMPLET KIT  
REAX-2108

1x REAX-106	2x REAX-347
1x REAX-114	1x REAX-348
1x REAX-151	1x REAX-350
1x REAX-160	1x REAX-356
1x REAX-163	3x REAX-360
1x REAX-164	1x REAX-363
1x REAX-171	1x REAX-370
1x REAX-210	1x REAX-540
5x REAX-301	1x REAX-602
1x REAX-302	1x REAX-764
1x REAX-303	1x REAX-765
3x REAX-308	1x REAX-766
4x REAX-309	1x REAX-770
6x REAX-315	1x REAX-777
6x REAX-342	1x REAX-948
5x REAX-345	1x REAX-977



 SEPARATION WITH AUTOMATIC HEAD  
 SEPARATION AVEC TETE AUTOMATIQUE  
 SEPARAÇÃO COM CABEÇA AUTOMÁTICA  
 SEPARACION CON CABEZAL AUTOMATICO



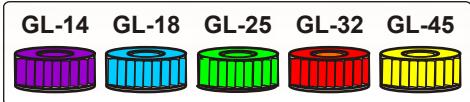

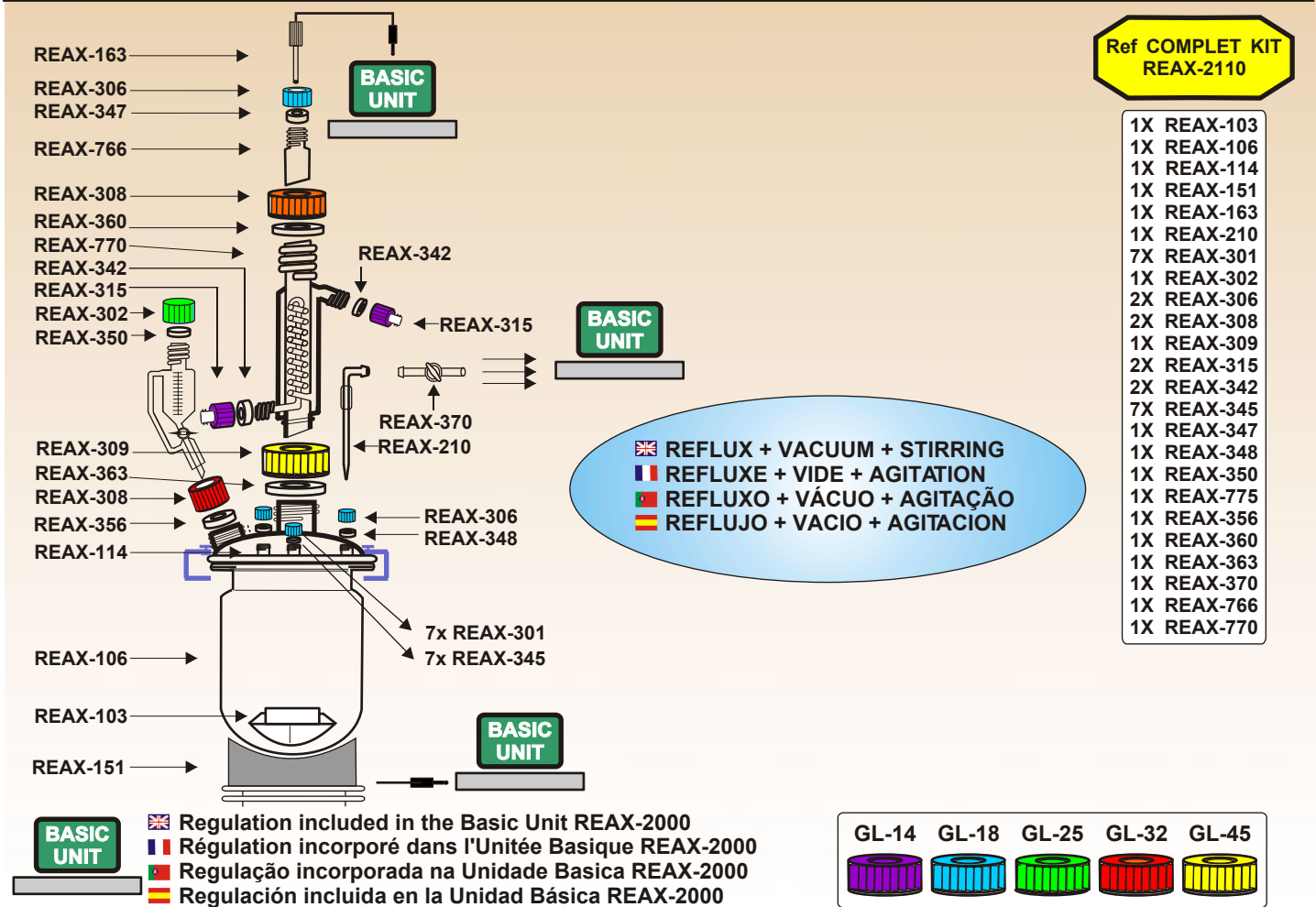
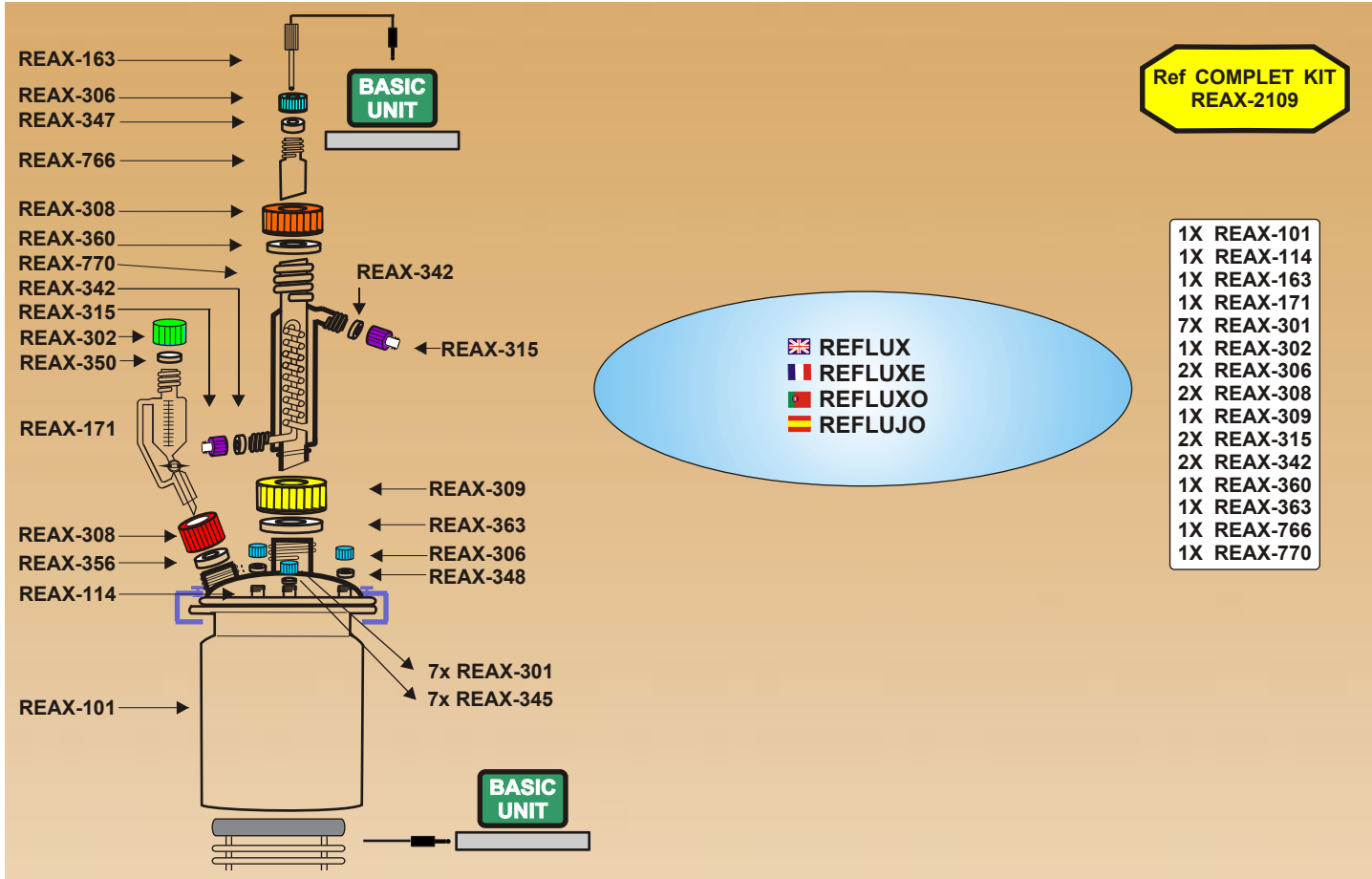
 Regulation included in the Basic Unit REAX-2000  
 Régulation incorporé dans l'Unitée Basique REAX-2000  
 Regulação incorporada na Unidade Basica REAX-2000  
 Regulación incluida en la Unidad Básica REAX-2000

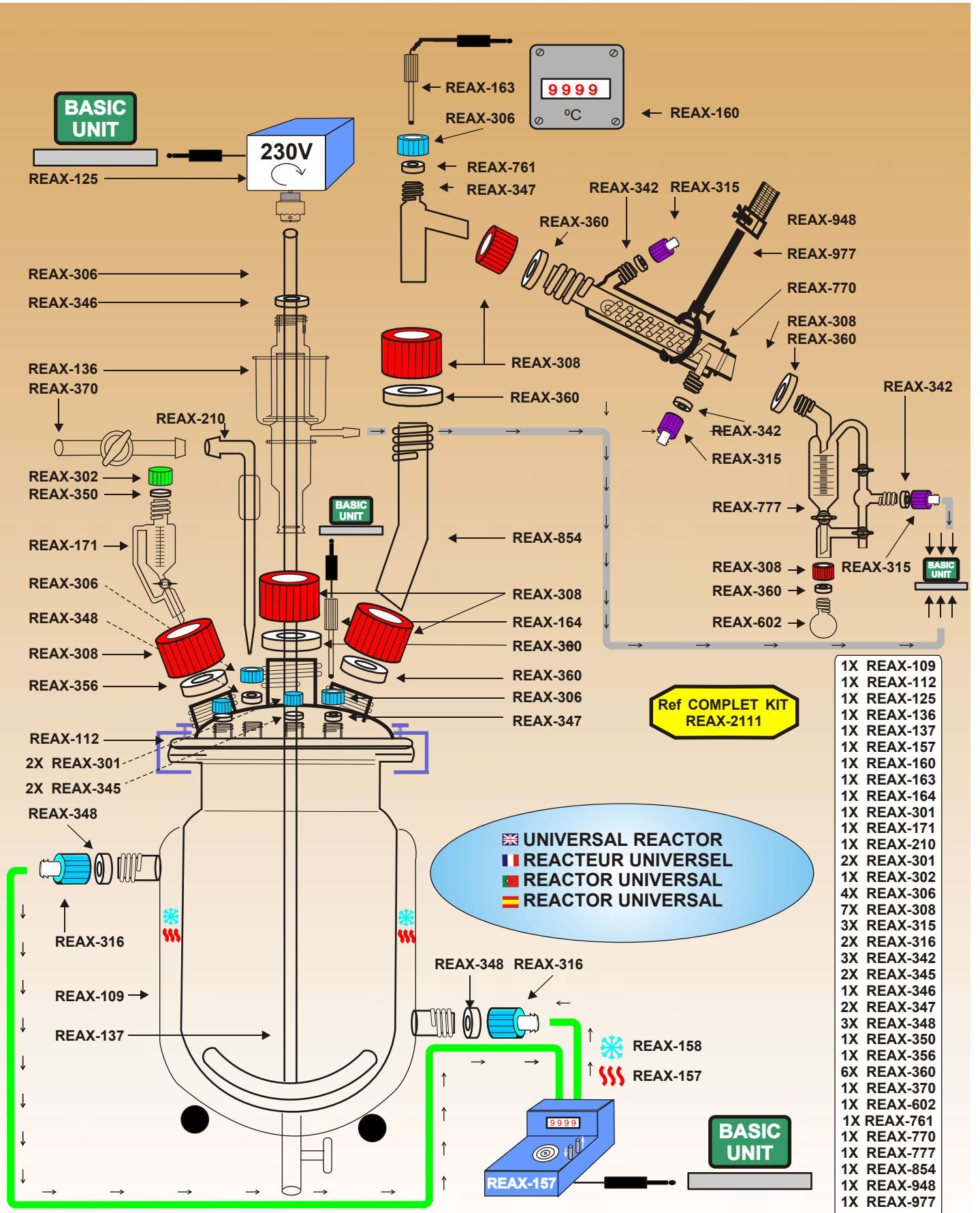









Ref **COMPLET KIT**  
REAX-2111

 **UNIVERSAL REACTOR**  
 **REACTEUR UNIVERSEL**  
 **REACTOR UNIVERSAL**  
 **REACTOR UNIVERSAL**

- 1X REAX-109
- 1X REAX-112
- 1X REAX-125
- 1X REAX-136
- 1X REAX-137
- 1X REAX-157
- 1X REAX-160
- 1X REAX-163
- 1X REAX-164
- 1X REAX-301
- 1X REAX-171
- 1X REAX-210
- 2X REAX-301
- 1X REAX-302
- 4X REAX-306
- 7X REAX-308
- 3X REAX-315
- 2X REAX-316
- 3X REAX-342
- 2X REAX-345
- 1X REAX-346
- 2X REAX-347
- 3X REAX-348
- 1X REAX-350
- 1X REAX-356
- 6X REAX-360
- 1X REAX-370
- 1X REAX-602
- 1X REAX-761
- 1X REAX-770
- 1X REAX-777
- 1X REAX-854
- 1X REAX-948
- 1X REAX-977

 Regulation included in the Basic Unit REAX-2000  
 Régulation incorporé dans l'Unitée Basique REAX-2000  
 Regulação incorporada na Unidade Basica REAX-2000  
 Regulación incluida en la Unidad Básica REAX-2000





SOXHLET EXTRACTOR  
 EXTRACTEUR SOXHLET  
 EXTRACTOR SOXHLET  
 EXTRACTOR SOXHLET

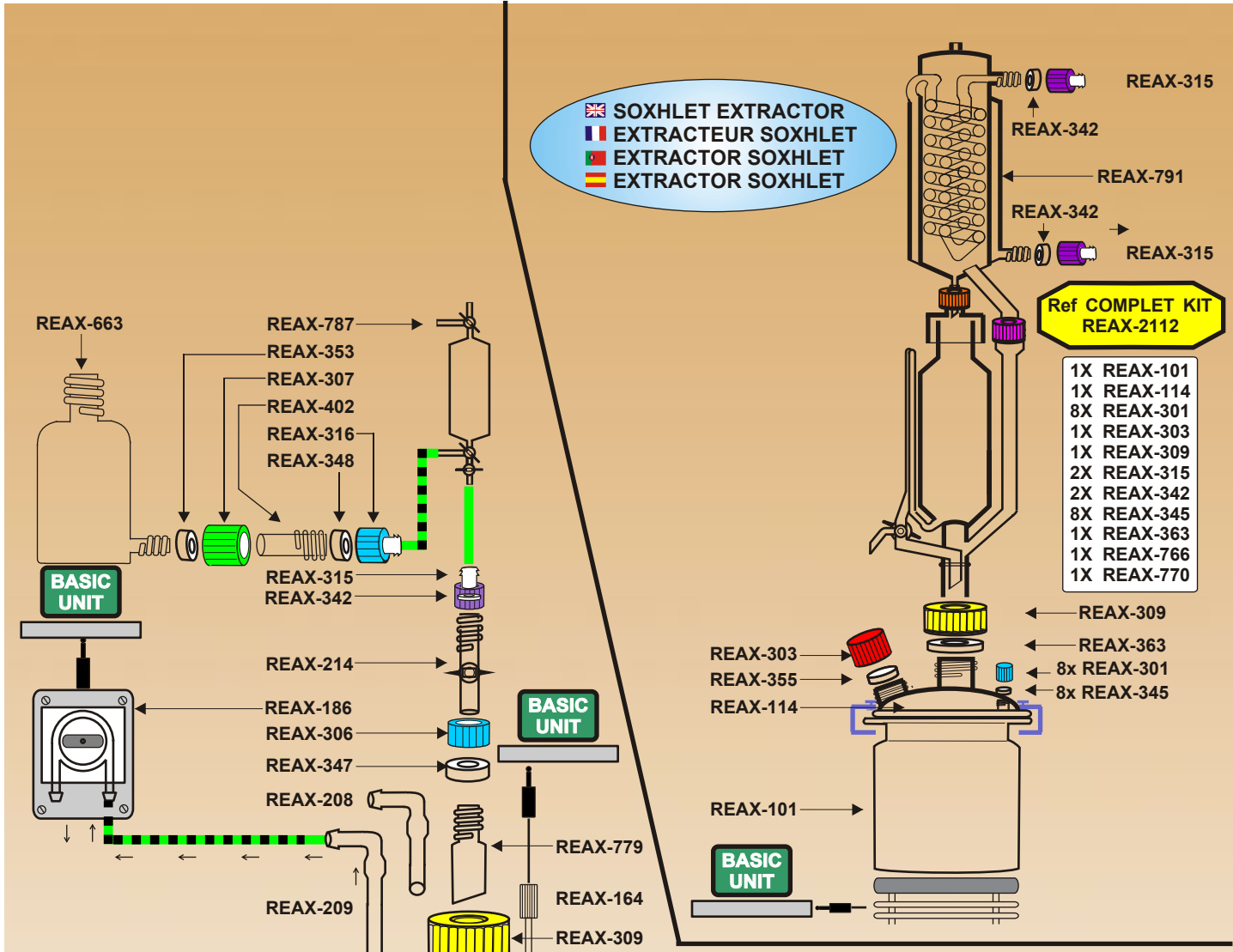

Ref COMPLET KIT REAX-2112

- 1X REAX-101
- 1X REAX-114
- 8X REAX-301
- 1X REAX-303
- 1X REAX-309
- 2X REAX-315
- 2X REAX-342
- 8X REAX-345
- 1X REAX-363
- 1X REAX-766
- 1X REAX-770

Ref COMPLET KIT REAX-2113

ANAEROBIC DIGESTION  
 DIGESTION ANAEROBIQUE  
 DIGESTÃO ANAERÓBICA  
 DIGESTION ANAEROBICA

- 1X REAX-101
- 1X REAX-113
- 1X REAX-131
- 1X REAX-157
- 1X REAX-164
- 1X REAX-186
- 1X REAX-208
- 1X REAX-209
- 1X REAX-214
- 5X REAX-301
- 4X REAX-306
- 1X REAX-307
- 1X REAX-309
- 1X REAX-315
- 4X REAX-316
- 5X REAX-345
- 2X REAX-347
- 4X REAX-348
- 1X REAX-353
- 1X REAX-362
- 1X REAX-663
- 1X REAX-779
- 1X REAX-787

Regulation included in the Basic Unit REAX-2000  
 Régulation incorporé dans l'Unitée Basique REAX-2000  
 Regulação incorporada na Unidade Basica REAX-2000  
 Regulación incluida en la Unidad Básica REAX-2000





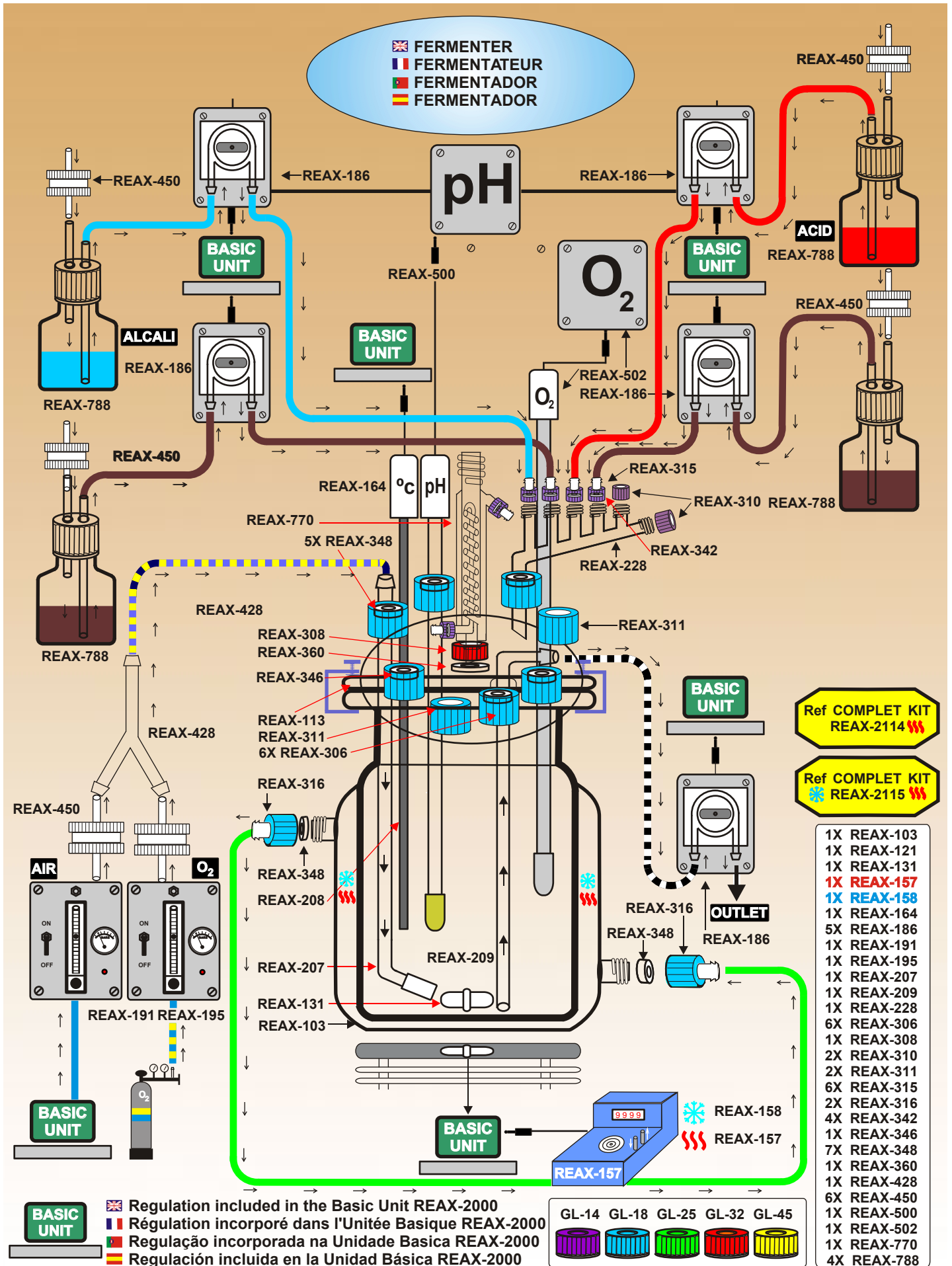

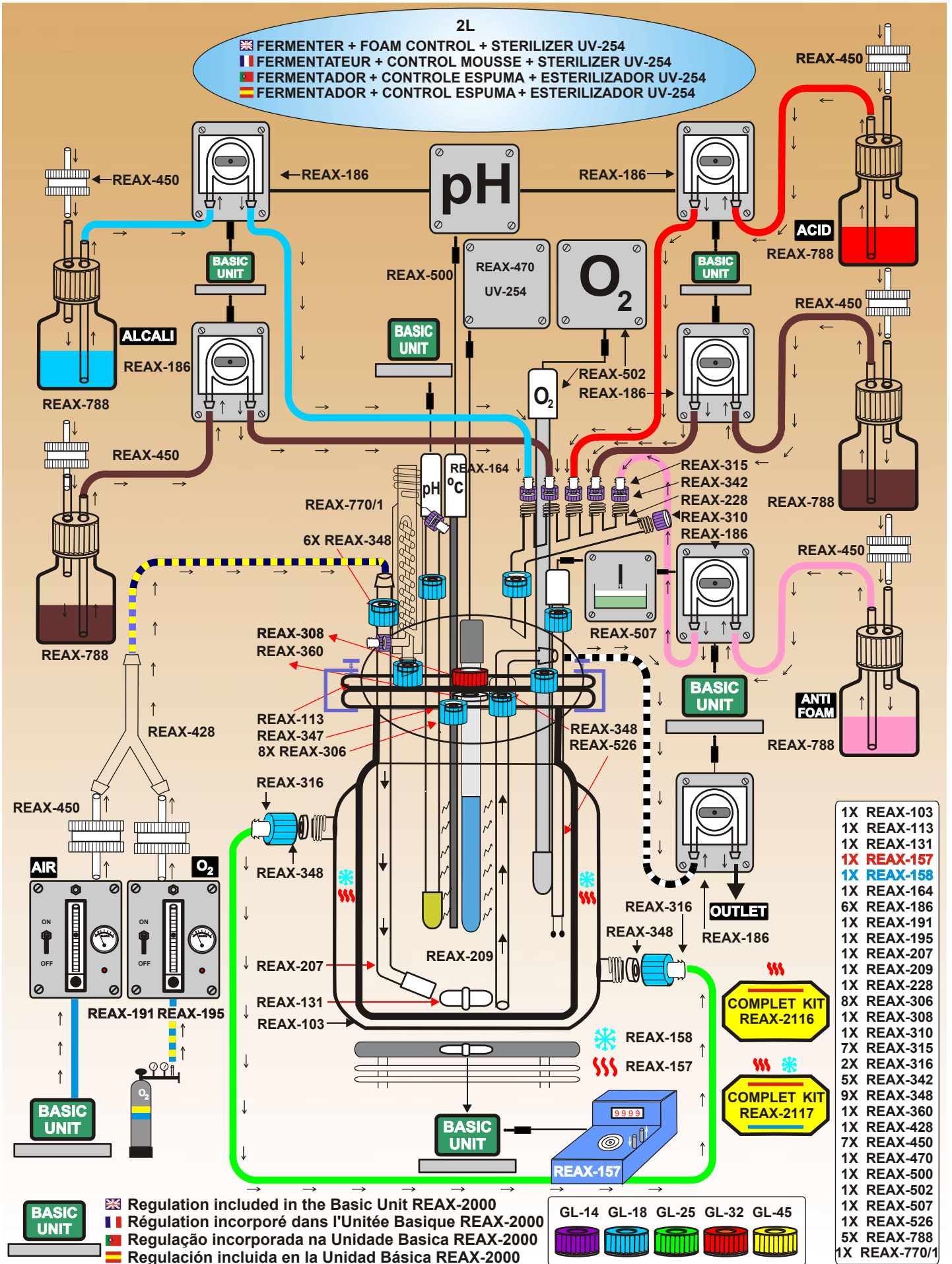



2L

UV-254nm THERMOSTATIC PHOTOCHEMICAL REACTOR  
 REACTEUR PHOTOCHEMIQUE THERMOSTATIQUE A UV-254nm  
 REACTOR FOTOQUÍMICO TERMOSTÁTICO A UV-254nm  
 REACTOR FOTOQUIMICO TERMOSTATICO A UV-254nm

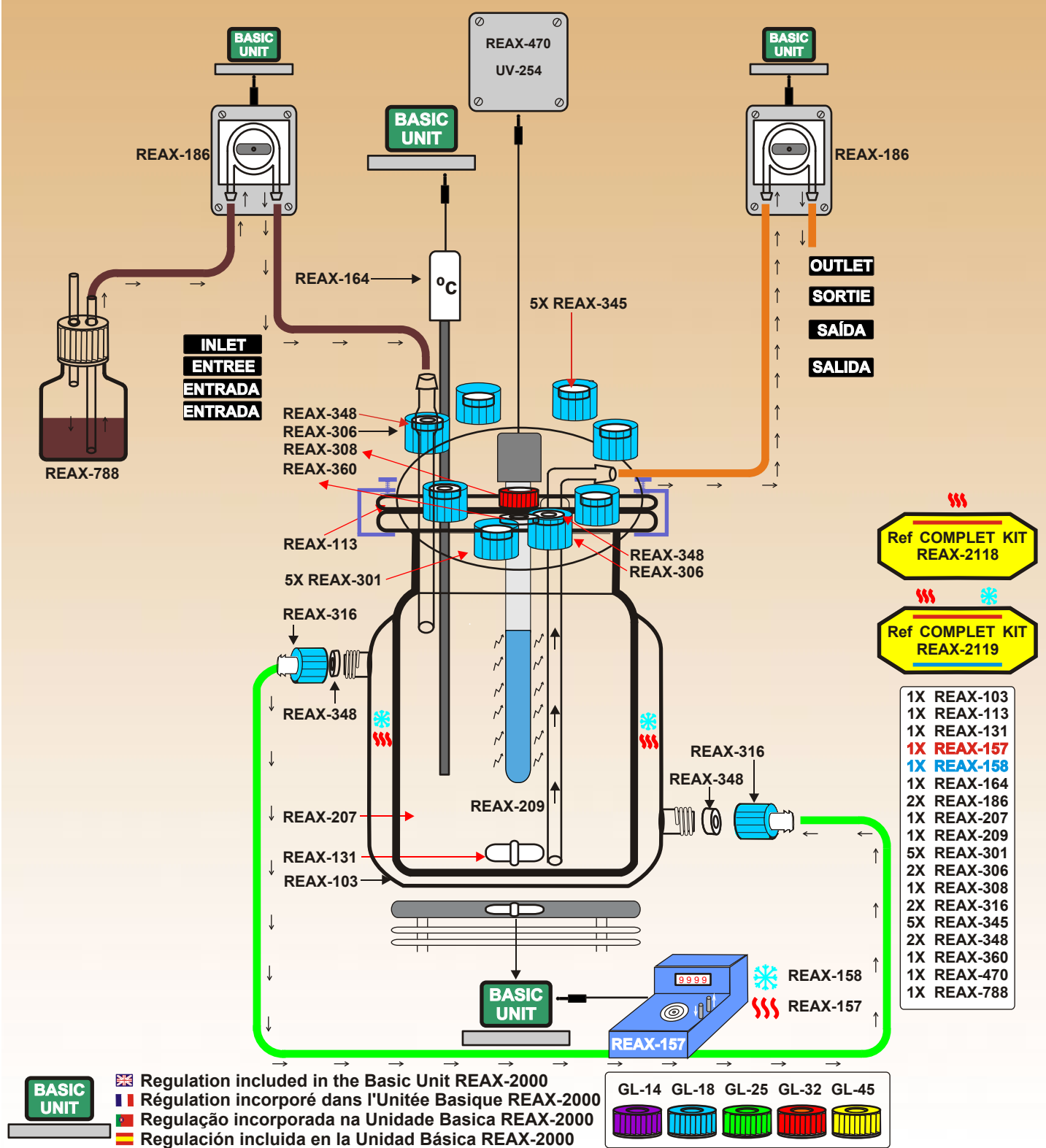



- Each station has:
- Magnetic stirrer
- Dual jacket reactor
- pH electrode
- pH regulator by 2 peristaltic pumps
- 1 Thermometer
- 2 Gas inlets
- 1 Outlet by p.pump
- 1 Septum inlet
- 1 Air sparger
- 1 Exhaust cooler
- 1 Reagent p.pump
- 1 Reagent flask
- 1 Drain outlet cap

- Chaque poste a:
- Agitateur magnétique
- Réacteur double chambre
- pH électrode
- pH régulateur par 2 pompes peristaltiques
- 1 Thermomètre
- 2 Entrées pour gas
- 1 Sortie Pompe péris.
- 1 Entrée septum
- 1 Difusueur d'air
- 1 Réfrigerant
- 1 Pompe Péris. réactifs
- 1 Flacon pour réactif
- 1 Robinet à vidange

1L COMPLET KIT REAX-2120

1L COMPLET KIT REAX-2121

4x 1L-2L

- FERMENTER
- FERMENTATEUR
- FERMENTADOR
- FERMENTADOR

2L COMPLET KIT REAX-2122

2L COMPLET KIT REAX-2123

- Cada estação tem:
- Agitador magnético
- Reactor dupla câmara
- pH elétrodo
- pH regulador com 2 bombas peristálticas
- 1 Termómetro
- 2 Entradas para gas
- 1 Saída bomba Peris.
- 1 Entrada Septum
- 1 Difusor de ar
- 1 Condensador
- 1 Bomba Per. reagente
- 1 Frasco reagente
- 1 Torneira drenagem

- Cada puesto tiene:
- Magnetoagitador
- Reactor encamisado
- pH electrodo
- pH regulador por 2 bombas peristálticas
- 1 Termómetro
- 2 Entradas de gas
- 1 Salida con bomba
- 1 Entrada Septum
- 1 Aireador
- 1 Refrigerante
- 1 Bomba P.reactivo
- 1 Frasco reactivo
- 1 Grifo desague

- COMMON: Basic unit, 1 Base flask, 1 Acid flask, 6 flow-meter rack gas 1, 6 flow-meter rack gas 2, 6 flow-meter rack air, 1 °C probe, 1 air filter, Bath.
- COMMUN: Basic unit, 1 Flacon base, 1 Flacon acide, 1 rack 6 rotamètres gas 1, 1 rack 6 rotamètres gas 2, 1 rack 6 rotamètres aire, 1 sonde °C, 1 filtre d'aire, Bain
- COMUM: Basic unit, 1Frasco Base, 1 Frasco ácido, 1 rack 6 rotamètres gas 1, 1 rack 6 rotamètres gas 2, 1 rack 6 rotamètres ar, 1 sonda °C, 1 filtro de ar, Banho
- COMUN: Basic unit, 1Frasco Base, 1 Frasco ácido, 1 rack 6 rotámetros gas 1, 1 rack 6 rotámetros gas 2, 1 rack 6 rotámetros aire, 1 sonda °C, 1 filtro de aire, Baño

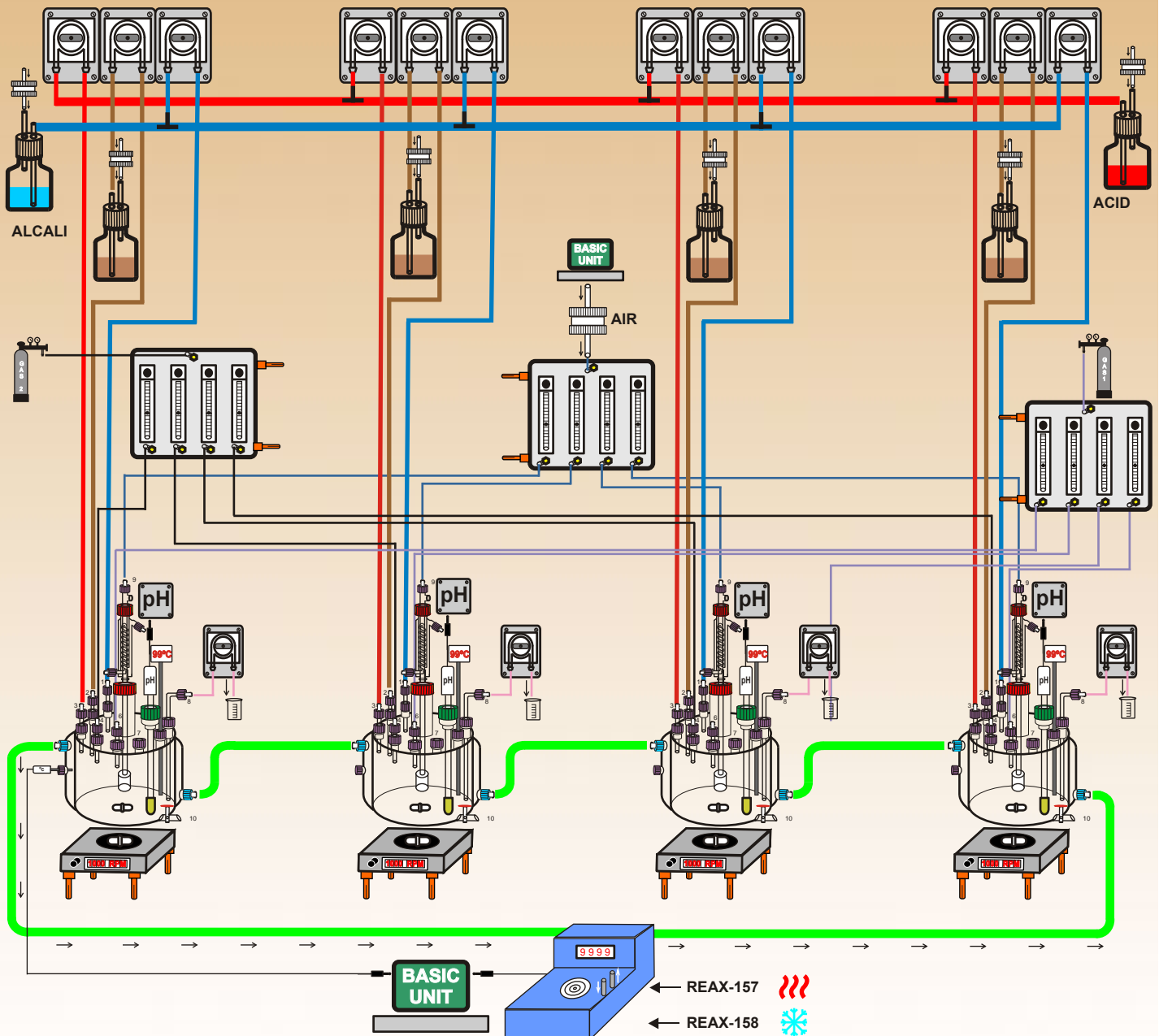

- Regulation included in the Basic Unit REAX-2000
- Régulation incorporé dans l'Unitée Basique REAX-2000
- Regulação incorporada na Unidade Basica REAX-2000
- Regulación incluida en la Unidad Básica REAX-2000

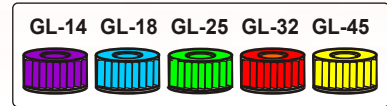





- Each station has:
- Magnetic stirrer
- Dual jacket reactor
- pH electrode
- pH regulator by 2 peristaltic pumps
- 1 Thermometer
- 2 Gas inlets
- 1 Outlet by p.pump
- 1 Septum inlet
- 1 Air sparger
- 1 Exhaust cooler
- 1 Reagent p.pump
- 1 Reagent flask
- 1 Drain outlet cap

- Chaque poste a:
- Agitateur magnétique
- Réacteur double chambre
- pH électrode
- pH régulateur par 2 pompes peristaltiques
- 1 Thermomètre
- 2 Entrées pour gas
- 1 Sortie Pompe péris.
- 1 Entrée septum
- 1 Difusor d'air
- 1 Réfrigérant
- 1 Pompe Péris. réactifs
- 1 Flacon pour réactif
- 1 Robinet à vidange

1L COMPLET KIT  
REAX-2124

1L COMPLET KIT  
REAX-2125

6x 1L-2L  
 FERMENTER  
 FERMENTATEUR  
 FERMENTADOR  
 FERMENTADOR

2L COMPLET KIT  
REAX-2126

2L COMPLET KIT  
REAX-2127

- Cada estação tem:
- Agitador magnético
- Reactor dupla câmara
- pH elétrodo
- pH regulador com 2 bombas peristálticas
- 1 Termómetro
- 2 Entradas para gas
- 1 Saída bomba Peris.
- 1 Entrada Septum
- 1 Difusor de ar
- 1 Condensador
- 1 Bomba Per. reagente
- 1 Frasco reagente
- 1 Tomeira drenagem

- Cada puesto tiene:
- Magnetoagitador
- Reactor encamisado
- pH electrodo
- pH regulador por 2 bombas peristálticas
- 1 Termómetro
- 2 Entradas de gas
- 1 Salida con bomba
- 1 Entrada Septum
- 1 Aireador
- 1 Refrigerante
- 1 Bomba P.reactivo
- 1 Frasco reactivo
- 1 Grifo desague

COMMON: Basic unit, 1 Base flask, 1 Acid flask, 6 flow-meter rack gas 1, 6 flow-meter rack gas 2, 6 flow-meter rack air, 1 °C probe, 1 air filter, Bath.  
 COMMUN: Basic unit, 1 Flacon base, 1 Flacon acide, 1 rack 6 rotamètres gas 1, 1 rack 6 rotamètres gas 2, 1 rack 6 rotamètres aire, 1 sonde °C, 1 filtre d'aire, Bain  
 COMUM: Basic unit, 1Frasco Base, 1 Frasco ácido, 1 rack 6 rotâmetros gas 1, 1 rack 6 rotâmetros gas 2, 1 rack 6 rotâmetros ar, 1 sonda °C, 1 filtro de ar, Banho  
 COMUN: Basic unit, 1Frasco Base, 1 Frasco ácido, 1 rack 6 rotâmetros gas 1, 1 rack 6 rotâmetros gas 2, 1 rack 6 rotâmetros aire, 1 sonda °C, 1 filtro de aire, Baño

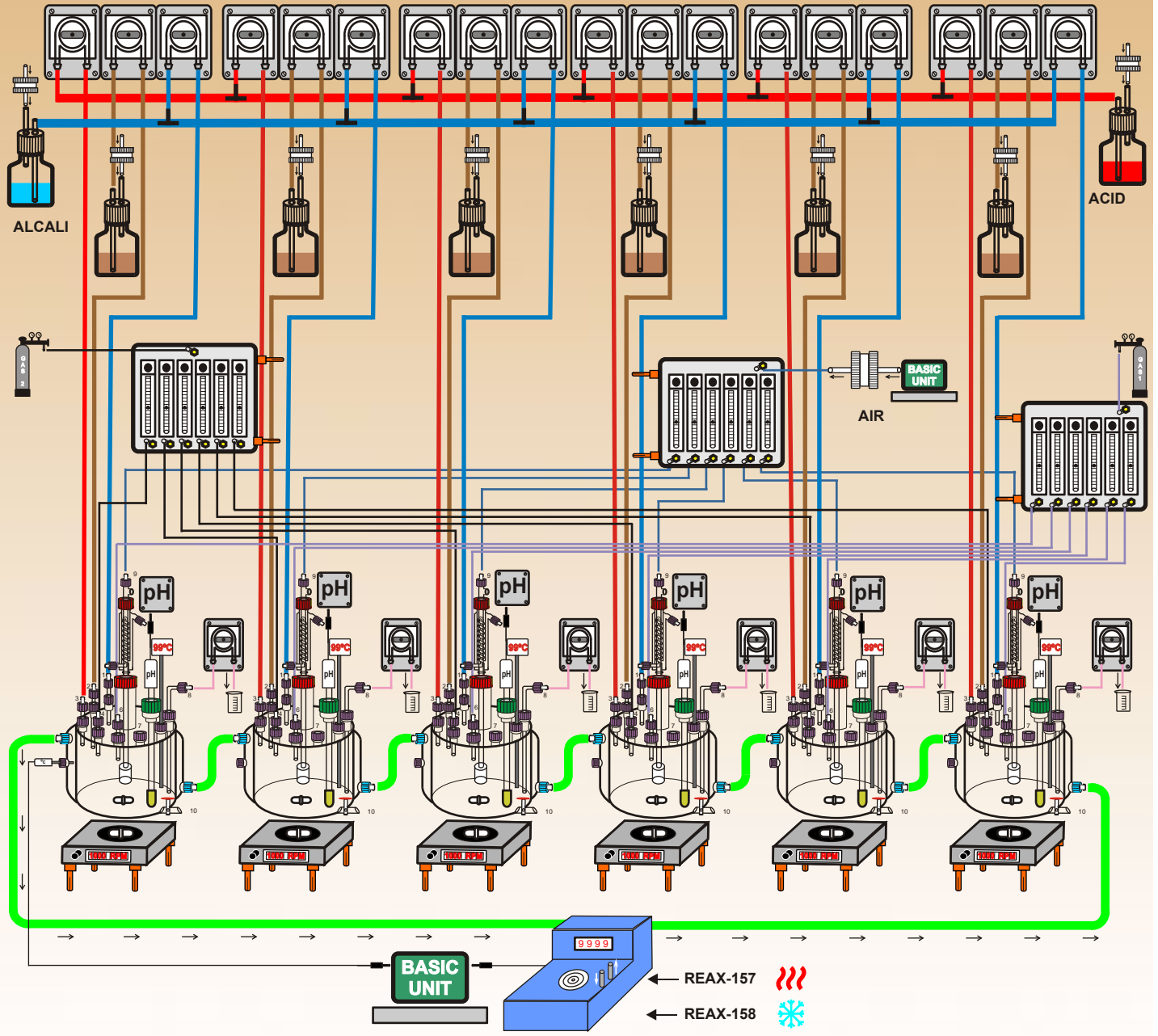

**BASIC UNIT**  
 Regulation included in the Basic Unit REAX-2000  
 Régulation incorporé dans l'Unitée Basique REAX-2000  
 Regulação incorporada na Unidade Basica REAX-2000  
 Regulación incluida en la Unidad Básica REAX-2000

