

Laboratory Glassware, Plasticware & Accessories

Azlon® • MBL® • Pyrex® • Quickfit®

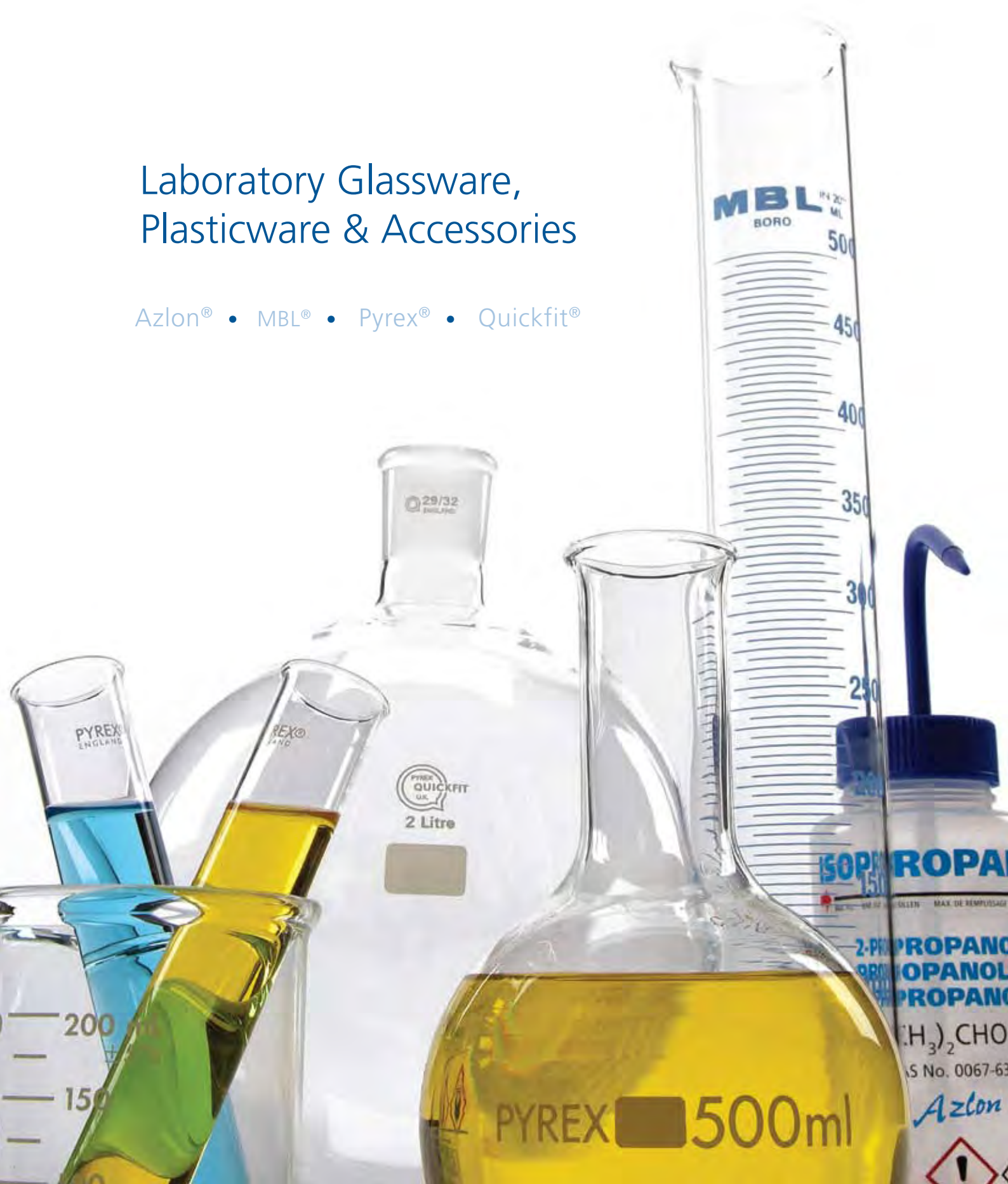

Page	Contents
2-3	Introduction
4	Our history
5-8	Our famous brands
9-10	Customised services
11	Contact us
12-21	Technical information - glassware
22-26	Technical information - plastics
27-281	Products A-Z
282-285	Index by product name
286-297	Index by item code
298	Order information
299	Terms & conditions of sale





Welcome to the second edition of the SciLabware glassware, plasticware and accessories catalogue.

The following pages feature nearly 3,000 general purpose and specialised glassware and reusable plastic laboratory products carrying some of the best known names in science - Azlon®, MBL®, Pyrex®, Quickfit® and Rotaflo®.

You will also find many completely new products, indicated with a 'NEW' flash.

From glass beakers and condensers to plastic measuring cylinders and washbottles, the comprehensive range of SciLabware consumables finds applications in all types of laboratory.

As a market leader in high quality laboratory consumables, we have an unrivalled reputation for product quality and customer service.

We work to the most rigorous International standards. Product excellence is achieved by the enforcement of strict quality standards and meticulous quality control, supported by the specialist skills of some of the worlds most experienced glassblowers and polymer technicians.

The result is a quality conscious culture committed to total customer satisfaction.

If you cannot find the information you need in this catalogue please don't hesitate to contact us and we will do our very best to help you.



FM 24272

SciLabware is an ISO9001:2008
registered company

Our history



SciLabware Limited is a relatively new name but our company has a long and distinguished history.

Our story began with two innovations in laboratory glassware. In 1923 a new heat resistant glass called Pyrex® was made under licence in the UK for the first time. Then in 1934 an assistant chemist and glassblower at the Triplex Safety Glass Company in Kings Norton, Birmingham, made some samples of laboratory glassware fitted with ground-glass conical joints, a development which attracted the interest of the Royal Society. Large scale manufacturing of the new product was soon underway.

In 1962 we began making the glassware in our new factory in Stone, Staffordshire, UK.

Following several acquisitions and a number of changes in ownership, in the 1980's the company became Barloworld Scientific, home of some of the world's most famous brand names in laboratory equipment and consumables.

In April 2008 the glassware and reusable plastic labware side of the business began trading as SciLabware Limited.

In 2011 the business became part of the DURAN Group, who are one of the world's leading manufacturers of borosilicate glass.

Today SciLabware is the leading European full range supplier of quality reusable laboratory ware, under the Pyrex*, Quickfit® MBL® and Rotaflo® brands for glassware and the Azlon® brand for plasticware. The company is still based in Staffordshire, UK and sells its products worldwide through a network of distributors.

Our company name has changed a few times over the years, but one thing has remained constant. As a market leader in high quality laboratory consumables, we have an unrivalled reputation for product quality and customer service, setting standards for others to follow.

* Pyrex is a trademark used under license from Corning Inc.

PYREX®

There are very few products made so well that the brand becomes a generic name for everything similar.

Pyrex® is one of the few.

Pyrex® borosilicate glass was developed in the early years of the 20th century to satisfy the demand for a material with high thermal resistance.

This property, coupled with excellent chemical durability, makes Pyrex® the ideal material for laboratory products.

Today more than 800 items of glassware carry the famous Pyrex® name including beakers, bottles, flasks, dishes and test tubes, all manufactured to the same exacting quality standards.



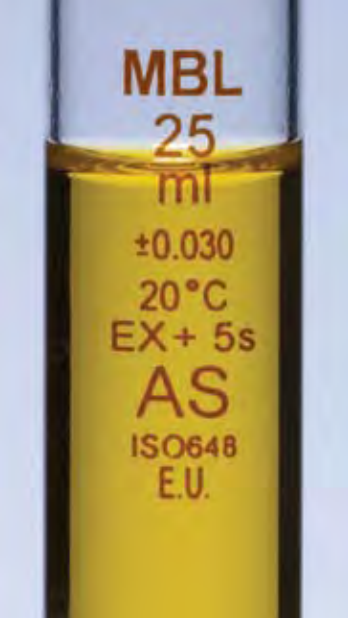

MBL® volumetric glassware has an international reputation for quality and performance. MBL® is ideal for general volumetric applications and offers exceptional value for money.

The range comprises over 300 products, one of the widest selections available, offering unbeatable choice, accuracy and performance.

Rotaflo® stopcocks are renowned for their performance and reliability. The range comprises a wide selection of general purpose stopcocks offering fine flow control and high vacuum versions, individually tested for guaranteed performance.

SVL® glassware has screwthread joints that are easily connected together using purpose made couplings. Only glass and PTFE come into contact with the chemicals being used to provide a grease-free and corrosion-resistant pathway.

SVL® glass is manufactured from Pyrex® borosilicate glass for maximum resistance to chemical attack and thermal shock.

MBL® ROTAFLO® SVL®



Quickfit® pioneered the concept of interchangeable joints in 1934. Today, the brand name is renowned throughout the world for quality and reliability and is the first choice of scientists who demand maximum performance and value for money.

Quickfit® ground-glass joints are precision manufactured with an accurate taper and smooth finish for leak-free performance and assured interchangeability.

The Quickfit® range comprises over 1,000 products, enabling the user to construct the widest choice of assemblies.

Quickfit® glassware is manufactured exclusively from Pyrex® borosilicate glass. This type of glass has a very low co-efficient of expansion, allowing use at both elevated and sub-zero temperatures.



Azlon

For more than half a century, the **Azlon®** name has been synonymous with high quality affordable plastic laboratory ware.

Available in a variety of polymers, Azlon® reusable plastics cover a broad range of applications in the modern laboratory, offering more than 700 products, including bottles, wash bottles, measuring cylinders, jugs and beakers.

Azlon® products are manufactured to the highest quality standards utilising a range of plastic moulding techniques including blow and injection moulding.

Leadership in polymer science and many important innovations have combined to make Azlon® one of the most widely known and respected brands in durable plastic labware.



Custom made glassware

We have been recognised as one of the worlds leading manufacturers of technical glassware for more than 70 years. We make over 2,500 standard products from beakers and bottles to flasks, dishes and test tubes.

Hoever, if you have a specialist glass application that is not covered by the items in this catalogue we are pleased to offer you our unique personal glassblowing services.

Whatever your industry or application, from the production of small to high volume quantities, you will find us helpful, competitive in price and unbeatable in quality.

We work to the most rigorous British and International standards and can offer the full spectrum of specialist glassware services including:

- Glassblowing
- Lathe Work
- Grinding and ground glass joints
- Moulding
- Cutting and shaping
- Glass sinters and filterware
- Calibration and graduation
- Screen-printing with your logo or message

Our skills and expertise are not only confined to the world of science. We have helped to develop glassware for projects from laser tubes for a laser optics company, apothecary bottles for a pharmaceutical chemist and from viscometers for an oil company, to glassware for an innovative piece of cookery equipment.

No matter how challenging your requirement, if the component material is glass and the priority is quality, we can provide the solution.

To find out to how you can turn your concept into a special glass product , follow the links on our website www.scilabware.com and enter your details. Our technical specialists will contact you to help you with your enquiry. Alternatively you can contact us by phone, fax or email:

Tel: +44(0)1785 810307
Fax: +44(0)1785 815066
E-mail: customglass@scilabware.com



Custom printed washbottles



Design your own washbottle and we will print it for you.

- Available in a range of bottle sizes from 250ml - 1000ml
- Wide or narrow mouth
- Venting or non-venting
- Choice of cap colours
- Minimum order 500 pieces

To find out more about our custom bottle printing service go to our website www.scilabware.com and enter your requirements in our custom printing enquiry form.

Alternatively you could send us an email at azlon@scilabware.com.

For more information about our full range of standard Driplok® venting and non-venting washbottles see pages 69 to 71 in this catalogue.

Contact us

The SciLabware range of glassware, reusable plasticware and accessories is available to customers through a worldwide network of distributors.

To find your local dealer, simply visit our website and click on the **Where to Buy** tab. If you need any additional help with sourcing contact our Customer Service Department for advice.

Our new website is a one-stop information hub for nearly 3,000 products from the Pyrex®, Quickfit®, MBL® and Azlon® brands. As well as full technical specifications for every item in our range it offers advice on selection of products and their usage from our qualified scientists and glass and polymer technologists. The website also has promotions, useful tips, FAQs, downloads, giveaways, images and product certification.

Our aim is to provide the highest level of customer care before, during and after the sale.

Head Office:

SciLabware Limited

Beacon Road

Walton Industrial Estate

Stone

Staffordshire ST15 0SA

United Kingdom

Tel +44 (0)1785 812121

Fax +44 (0)1785 811064

email: info@scilabware.com

www.scilabware.com



Glassware

Glass is an inorganic mixture of metal oxides fused together at high temperatures, which upon cooling, solidifies into the clear, rigid, non-crystalline, versatile material known widely across the globe.



Pyrex® Borosilicate Glass

All Pyrex®, Quickfit®, SVL® and many MBL® branded SciLabware products are manufactured from borosilicate glass (unless otherwise stated).

Standards

Pyrex® is a borosilicate glass which meets the specifications of the following standards:

ISO 3585, DIN 12217	Type 3.3 borosilicate glass
ASTM E-438	Type 1 Class A borosilicate glass
US Pharmacopoeia	Type 1 borosilicate glass
European Pharmacopoeia	Type 1 glass

Due to the demanding conditions that borosilicate glass is subjected to, maximum chemical toughness, minimum thermal expansion and high resistance to thermal shock make Pyrex® the ideal material for use in the laboratory.

Many SciLabware Ltd products also conform to other standards set out for laboratory glassware; for example beakers comply to ISO 3819 and volumetric flasks comply to ISO 1042 and DIN 12664. Typically these standards will specify not only glass type, but also dimensional detail, volumetric accuracy and tolerances.

Chemical Composition

Pyrex® glass has the following typical composition (% by weight):

SiO ₂	=	80.6%
B ₂ O ₃	=	13.0%
Na ₂ O	=	4.0%
Al ₂ O ₃	=	2.3%

Physical Properties

Coefficient of expansion (20 – 300°C)	=	3.3x10 ⁻⁶ K ⁻¹
Density	=	2.23g/cm ³
Refractive index (Sodium D line)	=	1.474
Dielectric constant (1MHz, 20°C)	=	4.6
Specific heat (20°C)	=	750J/kg°C
Thermal conductivity (20°C)	=	1.14W/m°C
Poissons Ratio (25 - 400°C)	=	0.2

Chemical Properties

Pyrex® borosilicate glass has a very high resistance to attack from water, acids, salt solutions, halogens and organic solvents. Only hydrofluoric acid, hot concentrated phosphoric acid and strong alkaline solutions cause appreciable corrosion of the glass.

Hydrolytic resistance

For many applications, it is important that laboratory glassware has excellent hydrolytic resistance; e.g. during steam sterilisation procedures, where repeated exposure to water vapour at high temperature can leach out alkali (Na⁺) ions. Pyrex® borosilicate glass has a relatively low alkali metal oxide content and consequently a high resistance to attack from water. Pyrex® fits into Class 1 of glasses for hydrolytic resistance according to ISO 719 (98°C) and ISO 720 (121°C).

Acid resistance

Glasses with a high percentage weight of silica (SiO₂) are less likely to be attacked by acids. Pyrex® borosilicate glass is over 80% silica and therefore remarkably resistant to acids (with the exception of hot concentrated phosphoric acid and hydrofluoric acid). Glass is separated into 4 acid resistance classes and Pyrex® corresponds to Class 1 in accordance with DIN 12116 and meets the requirements of ISO 1776.

Alkali resistance

Alkaline solutions attack all glasses and Pyrex® can be classified as moderately resistant. The alkali resistance of Pyrex® borosilicate glass meets Class 2 requirements as defined by ISO 695 and DIN 52322.

Temperature resistance

Pyrex® borosilicate glass has excellent thermal properties at both high and low temperatures. The maximum recommended working temperature for laboratory glassware manufactured from Pyrex® is 500°C (for short periods of time only). Special care should be taken at temperatures above 150°C to ensure both heating and cooling are achieved in a slow and uniform manner (see Care and Maintenance of Laboratory Glassware).

Pyrex® also performs excellently at lower temperatures. Pyrex® can withstand conditions down to approximately -192°C and is suitable for use with liquid nitrogen. In normal laboratory use, temperatures of -70°C are easily sustained for lengthy periods. Again special care should be taken to avoid sudden changes in temperature, and cooling should be achieved in a slow uniform manner.

Optical data

Pyrex® borosilicate glass is clear and colourless in appearance and thus transmits light through the visible range of the spectrum. This quality makes it ideal for work involving photochemical reactions, for example chlorinations. The graph (above) shows the degree of transmission of light as a function of wavelength in the ultra-violet, visible and infra-red regions of the spectrum. For the majority of glassware detailed in our catalogue, the thickness of the glass is 2–5mm.

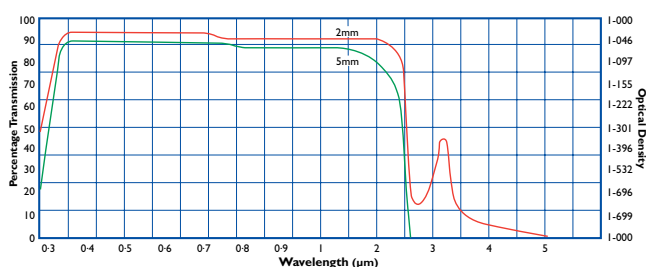

Amber coated Pyrex® glassware

Several SciLabware glass products, including media-lab bottles and volumetric flasks, are available in amber-coated glass. The glassware is coated on the exterior surface with a brown diffusion colour which results in a strong absorption in the short wavelength region up to 500nm. This feature is particularly useful when handling reagents that are light-sensitive.

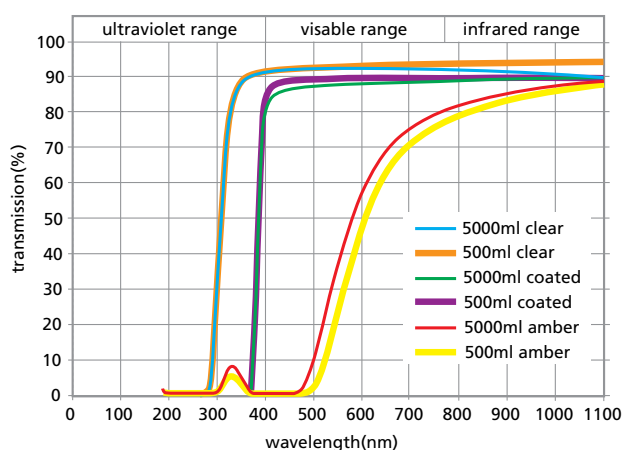

Glassblowing data

Listed in this catalogue are some Pyrex® and Quickfit® items that are suitable for further manipulation and processing. These items include stopcocks, ground glass joints, sinters and screwthreads. When working with these products, Glassblowers may find the following information useful regarding Pyrex® borosilicate glass:

Working point	=	1252°C
Softening point	=	821°C
Annealing point	=	565°C
Strain point	=	510°C

Pyrex® bottles with retrace codes

Pyrex® media bottles are used in many laboratory processes but they are also used in packaging, which often has to meet the strict requirements of the United States and European Pharmacopoeias (USP and EP), GMP and ISO 9000.

To meet these stringent requirements, all Pyrex® media bottles are now printed with a 'Retrace Code'. This retrace code allows the product to be traced to the point of production and the matching batch. This code is our commitment to support your quality management documentation and can be easily downloaded from the SciLabware web site by keying in the 8-digit code shown on the side of the bottle. 'Retrace' codes can be found on all Pyrex® 1516/: 1517/: 1518/: 1519/: and 1520/: series bottles.



Pyrex® bottles with plastic coating

The Pyrex® range of 1518: media-lab bottles have a plastic coating



to provide protection from mechanical impact and to help reduce leakage of the contents should the glass break.

The maximum working temperature for these bottles is 135°C but long term exposure (>30 mins) should be avoided.

Avoid exposure to direct heat from a hotplate or a Bunsen flame. The 1518: media bottle is suitable for freezing at -30°C and can also be used in microwave ovens.

Please note that the plastic coating does not increase the permissible pressure at which the bottles can be used and a protective screen is recommended for all pressure work.

Centrifuge tubes

This catalogue lists a number of Pyrex® and Quickfit® centrifuge tubes. Within the product information for each entry we advise the maximum Relative Centrifugal Force (RCF) they can be subjected to. Before centrifuging, it is important to calculate the actual RCF values that will be generated. This can quickly be determined by using the following nomogram.

To calculate the RCF value at any point along the tube, measure the radius, in mm, from the centre of the centrifuge spindle to the particular point.

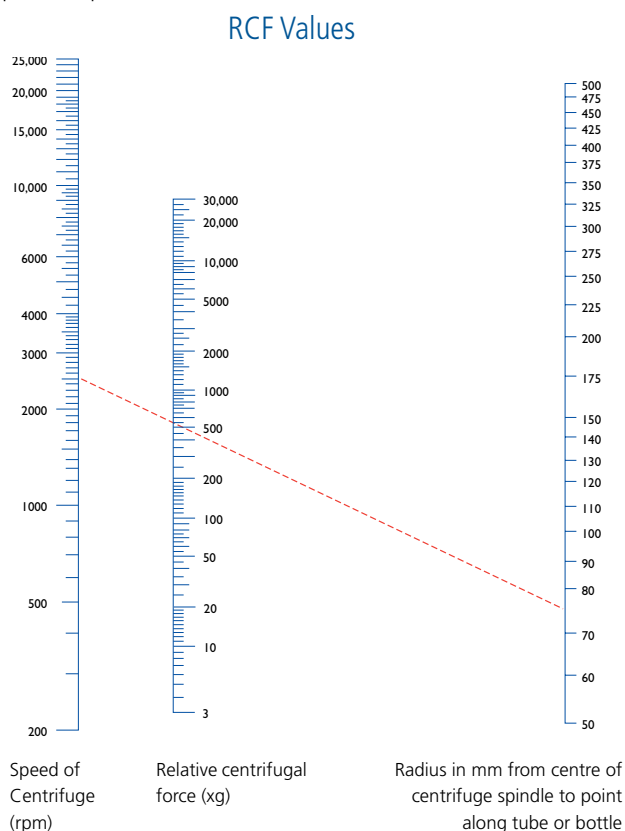

NB: The chosen point should be the base of the tube as this area will experience the maximum RCF.

Note the radius value from the right of the table and draw a line to the appropriate centrifuge speed value on the left hand column. The RCF value is the point where the line crosses the centre column.

The nomogram is based on the following equation:

$$RCF = (11.17 \times 10^{-7}) RN^2$$

R = Rotational radius (in mm)

N = Rotational speed (in RPM)

The allocated RCF values are for tubes in good condition. Do not use centrifuge tubes which are scratched, abraded or chipped as the strength will be seriously impaired.

Sintered discs

The SciLabware ranges of filtration glassware utilise sintered discs manufactured from Pyrex® borosilicate glass. Since they are manufactured from Pyrex® they are resistant to the majority of corrosive reagents, unaffected by ammonia, sulphuric acid and other solvents that are damaging to filter paper. The sintered glassware is available in six porosity classes from 0 – 5, as outlined in the table below. The pore sizes indicated, give a range of pores present within the sinter disc. Therefore, the size of particles that will be obstructed will generally be of a size at the upper end of the range.

Porosity Grade	ISO 4793 designation	Pore index (mic.)	Principal uses
0	P250	160 - 250	Coarse filtration, gas dispersion and support for other filter material
1	P160	100 - 160	Course precipitate filtration, gas dispersion, coarse grain material filtration
2	P100	40 - 100	Medium and crystalline precipitate filtration, medium filtration and washing of gases
3	P40	16 - 40	Analytical work with medium precipitates
4	P16	10 - 16	Analytical work with fine precipitates
5	P10	4 - 10	Bacteria filtration

In addition to the above detail, sinters should be treated under the same conditions as described in the general Pyrex® thermal properties as listed on page 13.

When using new sintered glassware for the first time, we recommend a wash with hydrochloric acid followed by several rinses with distilled water to remove any residual glass dust particles from the sinter.

Sintered discs (continued)

In order to select the correct sinter for any specific application, in addition to the porosity, it is also useful to know the flow rates of liquids and gases through the sinters. These values are given in the charts below for water and air. The data applies to 30mm diameter filter discs. The flow rates for other disc diameters can be calculated by multiplying the value read off by the conversion factor given in the table below.

Filter disc dia. mm	10	20	30	40	60	90	120	150	175
Conversion factor	0,13	0,55	1	1,5	2,5	4,3	6,8	9,7	15

Water flow rate

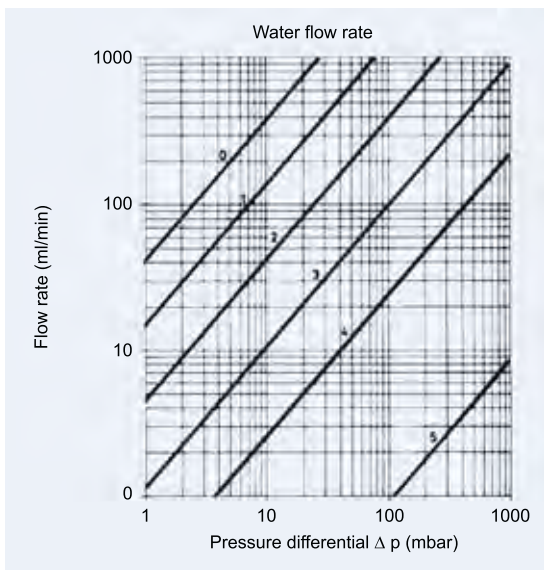

Dry-air flow rate

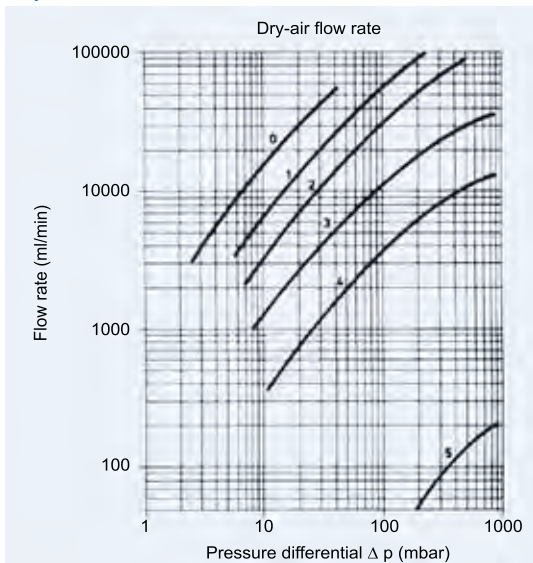

Quickfit® Products

Conical joints

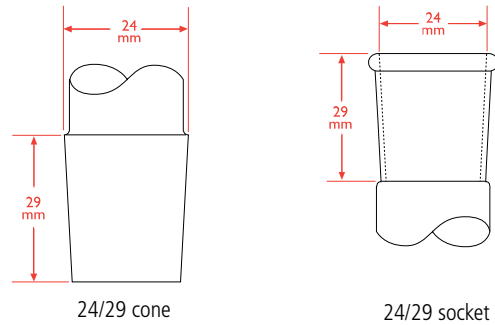

Spherical joints

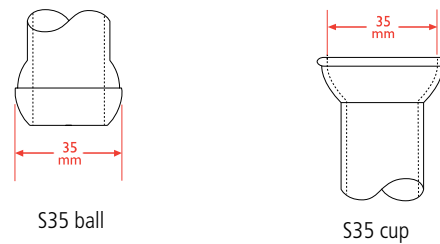

Flat flange

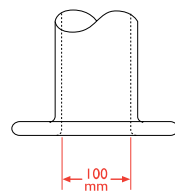

100mm bore flange

Screwthread

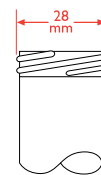

28 screwthread

Conical Joints - size designation

Size designation	Actual dia. of wide end (mm)	Actual dia. of narrow end (mm)	Nominal length of engagement (mm)
7/16	7.5	5.9	16
10/19	10.0	8.1	19
12/21	12.5	10.4	21
14/23	14.5	12.2	23
19/26	18.8	16.2	26
24/29	24.0	21.1	29
29/32	29.2	26.0	32
34/35	34.5	31.0	35
40/38	40.0	36.2	38
45/40	45.0	41.0	40
50/42	50.0	45.8	42
55/44	55.0	50.6	44
60/46	60.0	55.4	46

Quickfit® screwthread joints

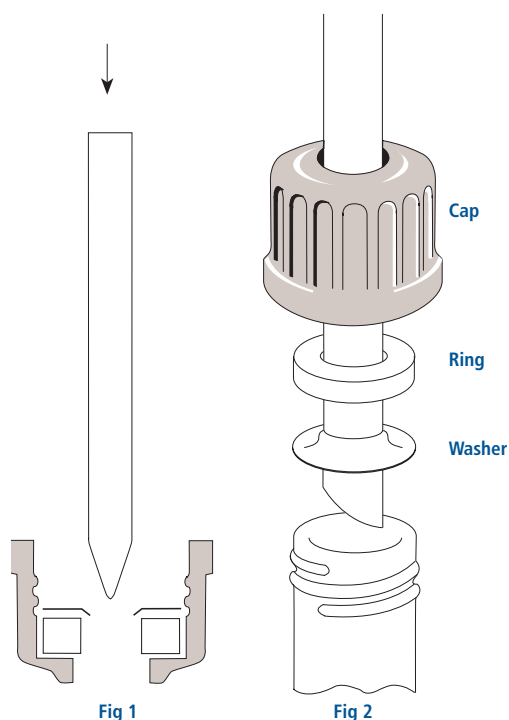

Screwcap assembly

When using screwthreads it is important that the PTFE washer is fitted carefully and correctly. This is best achieved by opening out the washer to the correct diameter using a tapered former. This should be carried out with the silicone rubber ring and PTFE washer in position in the plastic cap as shown in **Fig 1**. Withdraw the tapered former and remove the rubber ring and washer from the cap.

Fit each component separately to the fitting which is to be held, as shown in **Fig 2**, and screw the cap on to the thread. It is advisable that the ends of all fittings should be slightly tapered or fired in a Bunsen flame to remove sharp edges and produce a slight taper.

Quickfit® flask dimensions

The body diameter of Quickfit® Round Bottomed and Flat Bottomed flasks comply with ISO 1773 (BS 6352).

Nominal capacity ml	Approx bulb dia. 'a' mm	Approx bulb height 'b' mm	Nominal capacity ml	Approx bulb dia. 'a' mm	Approx bulb height 'b' mm
5	25	-	1000	132	115
10	30	-	2000	166	155
25	40	-	3000	188	-
50	50	40	5000	220	-
100	65	55	10000	279	-
150	75	65	20000	345	-
250	85	75	-	-	-
500	105	95	-	-	-

Quickfit® flask dimensions

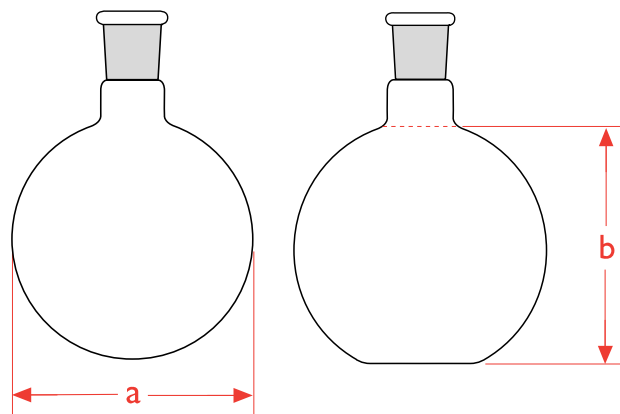

Volumetric Glassware

SciLabware Ltd manufactures two brands of volumetric glassware, Pyrex® and MBL®. As the name indicates Pyrex® volumetrics are manufactured solely from Pyrex® borosilicate glass. MBL® volumetric products are manufactured from borosilicate and soda-lime glass. Soda-lime glass is generally used for Class B products or where long term exposure to chemicals is unlikely, e.g. one mark pipettes.

Pyrex® volumetric glassware has superior thermal and chemical resistance and is better suited to glassware for storage of solutions, e.g. flasks.

The use of Pyrex® borosilicate glass for volumetric glassware means accuracy is retained over a longer working lifetime than their soda-lime equivalents. With everyday use, volumetric glassware requires recalibration. Soda-lime glass items will generally necessitate twice as many recalibrations as items constructed from borosilicate glass.

ASTM 542 and ISO 4787 international standards for calibration of laboratory volumetric glassware recommend that volumetric flasks are recalibrated at the following intervals (or sooner if chemical corrosion is observed): Borosilicate – 10 years; Soda-lime – 5 years.

Volumetric accuracy

SciLabware volumetric glassware is manufactured and calibrated in accordance with international ISO standards to permit very accurate determination and measurement of specific volumes. They are available in two accuracy classes: Class A/AS and Class B. The two classes differ in the accuracy of measurement with a Class A/AS being the highest accuracy, and class B is approximately half of a class A. Class AS has the same high tolerances as Class A, but is designed to permit more rapid outflow on burettes and pipettes.

Inscriptions

SciLabware volumetric glassware is manufactured and calibrated in accordance with international ISO requirements. All of our volumetric glassware is marked with a set of inscriptions in accordance with any specific standard associated with it.

Tolerance	Class A/AS – Highest level of accuracy. Class B – General purpose work calibrated to a lower level of accuracy
Standard	The standard to which the product conforms
Graduation	Pyrex® and MBL® volumetric glass is graduated in ml (millilitres) in accordance with ISO
IN	Calibrated to contain
EX	Calibrated to deliver
Blowout	Indication that last drop should be blown out of jet
Temp °C	All Pyrex® and MBL® volumetric glassware is calibrated at 20°C
Certification	All Class A/AS Works Certified glassware bears a serial number for identification and traceability.

Certification

Many of our range of volumetric products are available with certification. Our certificates confirm that the product has been tested for compliance to the appropriate standard. Below is an overview of the certification that is offered by SciLabware.

Works Certified Products



Pyrex® and MBL® Class A/AS Works Certified volumetric flasks, pipettes, cylinders and burettes are inscribed with an individual serial number and are supplied with an individual calibration certificate. Each certificate includes details of the actual volume, uncertainty estimation for the calibration and the required tolerance for compliance.

Batch certificates



For our ranges of Pyrex® Class A volumetric flasks and cylinders and MBL® Class AS pipettes a downloadable batch certificate is available from the SciLabware website. The batch certificate contains detailed information pertaining to the specific production batch including average volume and standard deviation for the batch.

To download a batch certificate visit www.scilabware.com and go the 'certificates' section then follow the links for the specified product. Simply enter the serial number marked on each volumetric item and the batch certificate is downloaded as a pdf.

Re-calibration

Normally, volumetric glassware only needs re-calibrating after extensive or demanding usage, which may have affected the original accuracy.

Re-calibration is usually not necessary if:

- The glassware is new but been in storage for some time. Age does not affect accuracy.
- The glassware is only subjected to moderate temperatures such as cleaning in a washing machine or sterilising in an autoclave at 121°C.
- The glassware has been used for less than 5 years with no repeated use of corrosive chemicals or strong acids/alkalis.

However, recalibration should definitely be considered under the following circumstances:

- The glassware is made from soda-lime glass and has been in use for 5 years.
- The glassware is made from borosilicate and has been in use for 10 years.
- The glassware has been subjected to temperatures in excess of 150°C.
- The glassware is frequently used with strong acids or bases.
- There are any signs of chemical corrosion e.g. frosting of internal glass surfaces.

Care and maintenance of laboratory glassware

SciLabware Ltd has a commitment to provide the highest quality glassware products. All of our glassware is manufactured with great care in order to provide you with a reliable piece of laboratory equipment. To obtain maximum life and performance from your glassware, correct handling is essential. The following notes will serve as a guide to new users and to remind more experienced handlers of the recommended procedures.

General precautions

Before using any piece of glassware, take time to examine it carefully and ensure that it is in good condition. Do not use any glassware which is scratched, chipped, cracked or etched. Defects like these can seriously weaken the glass and make it prone to breakage in use.

- Dispose of broken or defective glassware safely. Use a purpose-designed disposal bin that is puncture resistant and clearly labelled.



- Pyrex® laboratory glassware should under no circumstances be disposed of in a domestic glass recycling stream (e.g. bottle banks), since its high melting point make it incompatible with other glass (soda-lime glass) for recycling. The correct method of disposal is to include it in with general waste in accordance with the relevant guidelines, provided that the glass is free of any harmful chemical contamination.
- Never use excessive force to fit rubber bungs into the neck of glass aspirators, test tubes, conical flasks, etc. Take care to select the correct size.
- Many SciLabware products are provided with durable, easy to use screwthread connectors, to allow installation of any tubing. When attaching tubing, ensure the screwthread connector is removed from the glassware, the tubing is lubricated and protective gloves are worn. Never use excessive force to connect rubber hose or tubing.



- Lifting or carrying large glass flasks, beakers or bottles etc. by the neck or rim can be very dangerous. It is best to provide support from the base and sides.
- When stirring solutions in glass vessels, such as beakers and flasks, avoid using stirring rods with sharp ends which can scratch and weaken the glassware.
- Do not mix concentrated sulphuric acid with water inside a glass measuring cylinder. The heat of reaction can break the seal at the base of the cylinder.



- We recommend that all glassware is washed before it is first used.
- Wash glassware promptly after use to avoid hard dried residues. Use a biodegradable, phosphate free detergent, specially formulated for laboratory use.
- Do not use cleaning brushes which are badly worn and where the metal spine may scratch the glass.

Heating and cooling

The maximum recommended working temperature for Pyrex® and Quickfit® glassware is 500°C (for short periods only). However, once the temperature exceeds 150°C extra special care should be taken to ensure that heating and cooling is achieved in a slow and uniform manner.

- Pyrex® borosilicate glass is microwave safe. However, as with any microwave vessel, be sure it holds a microwave absorbing material, such as water, before placing in the oven. Many SciLabware items utilise plastic screwcaps and connectors. These are typically manufactured from polypropylene or PTFE, both of which are microwave safe.



- Do heat vessels gently and gradually to avoid breakage by thermal shock. Similarly, allow hot glassware to cool gradually and in a location away from cold draughts.



- If you are using a hotplate, ensure that the top plate is larger than the base of the vessel to be heated. Also, never put cold glassware onto a hotplate which is already well heated. Warm up gradually from ambient temperature.

- When autoclaving Pyrex® containers, e.g. bottles with screwcaps – always slacken off the caps. Autoclaving with tightly screwed caps can result in pressure differences and consequent breakage.

- If you are using a Bunsen burner, employ a soft flame and use a wire gauze with ceramic centre to diffuse the flame.



Preparation of media

Take great care when heating liquids that have a HIGH VISCOSITY. Viscous liquids can act as thermal insulators and can cause 'hot spots' leading to thermal breakage of the glassware. This is particularly important with MEDIA SOLUTIONS as the viscosity usually increases considerably during preparation.



- Do regularly stir the solution to assist even distribution of heat. If using a magnetic stirrer set the speed to ensure adequate agitation of the whole liquid.
- Do not use glass vessels with thick walls e.g. Pyrex® 'Heavy Duty Ware' or standard beakers or flasks which have capacities of 5 litres or greater.

Vacuum and Pressure Use

Because working conditions can vary enormously, SciLabware cannot guarantee any glassware against breakage when used under vacuum or pressure. The application of positive pressures inside glass apparatus is particularly hazardous and should be avoided if at all possible. Safety precautions should always be taken to protect personnel and a number of these are listed below:

- Always use an adequate safety screen and/or protective cage.
- Under no circumstances use glassware that is scratched, cracked or chipped. Its strength will be seriously impaired.
- Do not use flat bottomed vessels such as Erlenmeyer flasks and bottles under vacuum as they are likely to implode. Exceptions are vessels with specially thickened walls such as Büchner filter flasks and desiccators.
- Avoid stress caused by over-tightening clamps. Support glassware gently where possible.

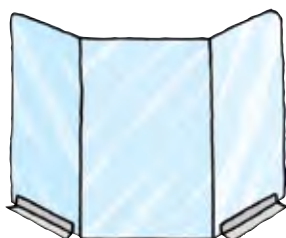

- Never subject glassware to sudden pressure changes. Always apply and release pressure gradients and vacuums gradually.

Ground Glass Joints

Lubricate the ground surfaces of joints to prevent leakage in use and facilitate separation. Use a silicone-free laboratory grease and apply a light coat completely around the upper part of the joint

Alternatively, consider PTFE joint sleeves which can be fitted between the cone and socket.

- If ground glass joints do seize, then the following remedies can be considered;

- Always wear thick protective gloves and safety spectacles. Never use force.



- Carefully rock the cone in its socket to achieve separation.
- If the joint is 'dry', try to provide lubrication. Hold the joint upright and add penetrating oil to the top of the cone. Wait until the penetrating oil is well into the joint before trying to separate.
- If the use of temperature is permissible, e.g. no volatile liquids present, then warm the outer socket under a running stream of hot water from the tap. Hold under the tap for a few minutes before trying to separate.

Sintered Glassware



New apparatus with sintered glass discs should be washed before use to remove loose particles of dust etc. Wash through with hot dilute hydrochloric acid followed by a thorough rinse with water.

- Do ensure that the porosity of the sintered disc is appropriate for the application. Porosity 0 sinters are for coarse filtration, whilst higher grades give progressively finer filtration.
- Never subject sintered glassware to differential pressures exceeding 100kN/m² (1 bar).

Volumetric Glassware

Do ensure that all volumetric glassware is kept scrupulously clean. Dirt, and especially grease, can distort the shape of the meniscus and also cause droplets of liquid to adhere to the vessel walls. Both seriously impair accuracy. (Good cleanliness is indicated by uniform wetting of the glass surface with distilled water).

- Never pipette by mouth. Always use a purpose designed pipette filler.
- Autoclaving at 121°C and cleaning in automatic dishwashers is acceptable and will not affect the accuracy of Pyrex® or MBL® glassware.



- All items should be held in a vertical position when reading the meniscus. The meniscus should be at eye level to avoid parallax errors.
- If using strong corrosive acids etc. select volumetric ware manufactured from chemically resistant Pyrex® borosilicate glass.
- Do not expose volumetric glassware to direct heat e.g. hotplates, bunsen flame.

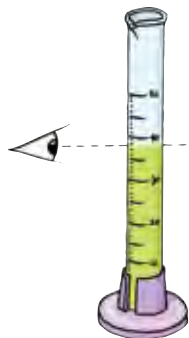

Pyrex® is a registered trade mark of Corning Inc. SciLabware is a registered user.

Physical properties and chemical resistance of plastics

These icons provide a quick guide as to the chemical resistance of the polymers and can be found throughout the catalogue where appropriate.



Moderate resistance to common aqueous laboratory chemicals, but avoid organic solvents, strong acids and bases



Excellent resistance to most laboratory chemicals



Good general resistance to a range of laboratory chemicals including acids, bases and some solvents



Can be subjected to autoclaving at 121°C without damage to the polymer.



Where no icon is shown, this product is made from several materials. In this instance please refer to the chemical resistance/physical properties chart for each polymer.

Polypropylene, PP

- Translucent rigid polymer
- Temperature range -20 to +135°C
- Autoclavable at 121°C
- Good to excellent chemical resistance
- Resistant to fatigue making it tough
- Typically used for beakers, bottles and cylinders



Polytetrafluoroethylene, PTFE

- Opaque rigid polymer
- Wide temperature range -200 to +260°C
- Autoclavable at 121°C
- Unrivalled resistance to almost all chemicals
- Extremely low friction coefficient
- Typically used for bottles, beakers and stirrers



Low Density Polyethylene, LDPE

- Translucent flexible polymer
- Narrow temperature range of -50 to +80°C
- Not autoclavable at 121°C
- Good to excellent chemical resistance
- Robust and virtually unbreakable
- Typically used for wash bottles



Polymethylmethacrylate, Acrylic (PMMA)

- Transparent rigid polymer
- Narrow temperature range -60 to +50°C
- Not autoclavable at 121°C
- Moderate chemical resistance
- Very tough and high clarity
- Typically used for radiation shields



High Density Polyethylene, HDPE

- Translucent rigid polymer
- Broad temperature range of -100 to +120°C
- Not autoclavable at 121°C
- Good to excellent chemical resistance
- High tensile strength making it very tough
- Typically used for bottles



Polystyrene, PS

- Transparent rigid polymer
- Narrow temperature range -40 to +90°C
- Not autoclavable at 121°C
- Moderate chemical resistance
- Brittle yet has excellent clarity
- Typically used for container ware



Polymethylpentene, PMP (TPX)

- Transparent rigid polymer
- Broad temperature range -180 to +145°C
- Autoclavable at 121°C
- Good to excellent chemical resistance
- Has a low density and a high clarity
- Typically used for beakers and cylinders



Polyvinylchloride, PVC

- Rigid polymer
- Narrow temperature range -25 to +70°C
- Not autoclavable at 121°C
- Moderate chemical resistance
- Rigid or flexible, coloured or clear
- Typically used for trays and troughs



Polycarbonate, PC

- Transparent rigid polymer
- Broad temperature range -135 to +135°C
- Autoclavable at 121°C
- Moderate chemical resistance
- High impact strength
- Typically used for safety shields



Physical properties of plastics

	LDPE	HDPE	PP	PMP (TPX)	PC	PS	PMMA	PTFE	
Max usage Temp. °C	80	120†	135	145	135	90	50	260	
Min usage Temp. °C	-50	-100	-20††	-180	-135	-40	-60	-200	
Transparency	Translucent	Translucent	Translucent	Clear	Clear	Clear	Clear	Opaque	
Flexibility	Flexible	Rigid	Rigid	Rigid	Rigid	Rigid	Rigid	Rigid	
Specific Gravity	0.92	0.95	0.9	0.83	1.2	1.05	1.2	2.2	
Microwaveable	Yes	No	Yes	Yes	Marginal	No	No	Yes	
Autoclavable	No	No	Yes	Yes	Yes	No	No	Yes	
Sterilisation	Gas	Yes	Yes	Yes	Yes	Yes	No	Yes	
	Dry Heat	No	No	No	Yes	No	No	Yes	
	Radiation (Gamma)	Yes	Yes	No	No	Yes	Yes	Yes	
	Disinfection	Yes	Yes	Yes	Yes	Yes	Some	Some	Yes
Permeability*	N ₂	180	42	48	8,000	50	25	3	Unknown
	O ₂	500	185	240	32,000	300	400	12	308
	CO ₂	2,700	580	800	115,000	1,075	1,500	68	Unknown
	Water Absorption (%)	<0.01	<0.03	<0.2	0.01	0.35	0.05	0.35	<0.01
Cytotoxic	No	No	No	No	No	No	No	No	

* Permeability (cc-mm/m²-24hr.Bar).

† Polymer may be malleable at temperatures above 80°C if the product is under structural stress.

†† Material may become brittle at low temperatures.

Food safety

Food Contact/Animal Derivative Statement

SciLabware can confirm that in respect to contact of plastic materials with foodstuffs our suppliers comply with the following:

EU Directive 2002/72 relating to plastic materials and articles intended to come into contact with foodstuffs.

Code of Federal Regulation (CFR), Title 21, Food and Drug Administration (FDA), Part 177.1520 "Olefin Polymers", (a) 2(i) and (c) 2.1 and 2.2.

We can also confirm that in respect to Bovine Spongiform Encephalopathy (BSE) / Transmissible Spongiform Encephalopathy (TSE), that our suppliers do not use tallow derived from animal sources in the manufacture of our products.

EU Regulation 1907/2006/EC (REACH)

Regulation EC No.1907/2006 of the European Parliament and of the council concerning the Registration, Evaluation, Authorisation and restriction of Chemicals (REACH) is continually being reviewed and updates implemented.

After consultation with the UK Health and Safety Executive (HSE) and Smithers REACH Services (SRS), SciLabware Limited is deemed to be a 'Distributor of Articles' (Finished products) for laboratory products.

Laboratory Plastics (Azlon®)

The laboratory plastics we supply are deemed as articles under REACH and therefore require no (Pre-) registration as there is 'no intended release of chemicals from these products'. SciLabware Limited products, to the best of our knowledge and that of our suppliers, do not contain SVHC's above thresholds of 0.1% on a weight/weight basis.

Laboratory Glassware (Pyrex®, Quickfit®, and MBL®)

In the framework of the REACH Regulation (1907/2006/EC) glass

is exempt from registration under Annex V item 11 (Commission Regulation 987/2008/EC) of 8 October 2008 amending Regulation 1907/2006/EC)

Lipsol® Detergent

We are in constant communication with the manufacturers of Lipsol® to ensure that any relevant REACH (Pre) registration requirements are met. We confirm that Lipsol does not contain any SVHC's above the threshold of 0.1% on a weight/weight and is compliant with REACH. For full up to date information on REACH, please visit our website.

Recycling plastics

Although our products are designed for the reusable market you may wish to dispose of them at some point. Therefore here is some advice on recycling of our plastics.

Recycling involves the segregation of plastic products by specific resin types ready for the process of converting them into new raw materials for use in other products.

In order to assist with this segregation, the Society of the Plastics Industry (SPI) had adopted a classification system to identify the seven main types of plastic where each resin is assigned a number.

A large proportion of our products also have the following SPI code permanently moulded into them: -



The seventh classification, or "other" denotes that the product is either not of the preceding plastics or it is a mixture.

SciLabware does not currently supply any products made from PET.

Before recycling any items, please consider the environment and further handling. All items should be washed, cleaned and/or disinfected prior to disposal.

Chemical resistance of plastics

 **Excellent resistance:**
continuous exposure to the substance does not cause damage within 30 days.

	LDPE		HDPE		PP		PMP (TPX)		PVC		PC		PS		SAN		PMMA		PTFE		POM		
	20	50	20	50	20	50	20	50	20	50	20	50	20	50	20	50	20	50	20	50	20	50	
Temperature °C																							
Acetaldehyde	●	▲	●	■	■	▲	■	▲	▲	▲	■	▲	▲	▲	▲	▲	▲	▲	▲	●	●	●	●
Acetic Acid (Glacial)	■	▲	●	●	●	■	■	■	●	▲	▲	▲	▲	▲	▲	▲	▲	▲	▲	●	●	▲	▲
Acetic Anhydride	▲	▲	■	■	■	■	●	■	▲	▲	▲	▲	▲	▲	▲	▲	▲	▲	▲	●	●	▲	▲
Acetone	■	▲	▲	▲	■	▲	●	●	▲	▲	▲	▲	▲	▲	▲	▲	▲	▲	▲	●	●	●	●
Ammonium Chloride (10%)	●	●	●	●	●	●	●	●	●	■	■	■	●	●	●	●	■	■	●	●	□	□	
Ammonium Hydroxide (30%)	●	●	●	●	●	●	●	●	●	▲	▲	■	■	■	■	■	■	■	●	●	●	●	
Amyl Acetate	■	▲	●	■	■	▲	●	■	▲	▲	▲	▲	▲	▲	▲	▲	▲	●	●	●	●	●	
Aniline (Phenylamine)	●	■	●	●	●	●	●	■	▲	▲	▲	▲	▲	▲	▲	▲	▲	▲	●	●	■	■	
Aqua Regia	▲	▲	▲	▲	▲	▲	▲	▲	▲	▲	▲	▲	▲	▲	▲	■	▲	▲	▲	●	●	●	●
Benzaldehyde	●	■	■	▲	▲	■	●	■	▲	▲	▲	▲	▲	▲	▲	▲	▲	▲	▲	●	●	●	●
Benzene	▲	▲	▲	▲	▲	▲	▲	▲	▲	▲	▲	▲	▲	▲	▲	▲	▲	▲	▲	●	●	●	■
Benzoic Acid	●	●	●	●	●	■	●	●	●	■	●	■	■	■	●	●	●	●	●	●	□	□	
Boric Acid (10%)	●	●	●	●	●	●	●	●	●	●	●	●	●	●	●	●	●	●	●	●	●	●	●
Butyl Acetate	■	■	■	■	■	■	■	■	●	▲	▲	▲	▲	▲	▲	▲	▲	▲	▲	●	●	●	■
Butyric Acid (Butanoic acid)	▲	▲	■	▲	▲	▲	▲	▲	●	▲	▲	▲	▲	▲	▲	▲	▲	▲	▲	●	●	□	□
Calcium Hydroxide (Saturated)	●	●	●	●	●	●	●	●	●	▲	▲	■	■	●	●	■	▲	●	●	●	●	●	
Carbon Disulphide	▲	▲	▲	▲	▲	▲	▲	▲	▲	▲	▲	▲	▲	▲	▲	▲	▲	▲	▲	●	●	●	●
Carbon Tetrachloride	■	▲	■	▲	■	▲	▲	▲	●	▲	▲	▲	▲	▲	■	▲	▲	▲	▲	●	●	■	■
Chloroform	■	▲	■	▲	▲	▲	▲	▲	▲	▲	▲	▲	▲	▲	▲	▲	▲	▲	▲	●	●	▲	▲
Citric Acid (1M)	●	●	●	●	●	●	●	●	●	●	●	●	●	●	●	●	●	□	●	●	□	□	
Cresol	▲	▲	■	▲	■	■	▲	▲	▲	▲	▲	▲	▲	■	▲	▲	▲	▲	▲	●	●	□	□
Cyclohexane	■	▲	■	▲	■	▲	▲	▲	▲	▲	●	■	▲	▲	■	▲	■	□	●	●	●	●	
Dibutyl Phthalate	■	▲	■	▲	■	■	■	■	▲	▲	■	▲	▲	▲	▲	▲	▲	▲	▲	●	●	●	●
Dichlorobenzene	■	▲	■	▲	■	▲	▲	▲	▲	▲	▲	▲	▲	▲	▲	▲	▲	▲	▲	●	●	▲	▲
Diethyl Ether	▲	▲	■	▲	■	▲	▲	▲	●	▲	▲	▲	▲	▲	▲	▲	▲	▲	▲	●	●	●	●
Diethylene Glycol	●	●	●	●	●	●	●	●	■	▲	■	■	●	●	●	●	▲	▲	▲	●	●	●	●
Dimethyl Formamide (DMF)	●	●	●	●	●	●	●	●	▲	▲	▲	▲	▲	▲	▲	▲	▲	▲	▲	●	●	●	●
Dimethyl Sulfoxide (DMSO)	●	●	●	●	●	●	●	●	▲	▲	▲	▲	□	■	▲	▲	▲	▲	▲	●	●	□	□
Dioxane	■	■	■	■	▲	▲	■	■	▲	▲	▲	▲	▲	▲	▲	▲	▲	▲	▲	●	●	■	■
Ethyl Acetate (Ethyl Ester)	●	●	●	●	■	▲	■	▲	▲	▲	▲	▲	▲	▲	▲	▲	▲	▲	▲	●	●	□	□
Ethyl Alcohol (Absolute Ethanol)	●	■	●	●	●	●	●	■	●	●	■	●	■	▲	▲	▲	▲	▲	▲	●	●	●	●
Ethyl Chloride (Chloroethane)	■	▲	▲	▲	■	▲	■	▲	▲	▲	▲	▲	▲	▲	▲	▲	▲	▲	▲	●	●	□	□
Ethylene Chloride	■	▲	▲	▲	■	▲	■	▲	▲	▲	▲	▲	▲	▲	▲	▲	▲	▲	▲	●	●	▲	▲
Ethylene Oxide (Pure)	■	■	●	●	●	●	■	■	■	■	●	●	●	■	■	■	●	●	●	●	●	●	●
Ethylene Oxide (Gas)	■	■	●	●	●	●	■	■	■	■	●	●	●	■	■	■	●	●	●	●	●	□	□
Formaldehyde (Formalin) 40%	●	■	●	■	●	●	●	●	●	●	●	●	■	■	■	▲	●	■	●	●	●	●	●
Formic Acid (50%)	■	■	●	●	●	■	●	●	●	▲	■	■	■	■	●	■	□	□	●	●	□	□	
Formic Acid (100%)	■	■	●	●	●	■	●	●	▲	■	▲	■	■	▲	▲	□	□	●	●	▲	▲	▲	
Glycerine (Glycerol)	●	●	●	●	●	●	●	●	●	●	●	●	●	●	●	●	●	●	●	●	●	■	■

Technical information - plasticware

Good resistance;
continuous exposure to the substance causes minor damage within 7 - 30 days

Poor resistance:
not suitable for continuous exposure to the substance. Immediate damage may occur

No information available

	LDPE		HDPE		PP		PMP (TPX)		PVC		PC		PS		SAN		PMMA		PTFE		POM			
	20	50	20	50	20	50	20	50	20	50	20	50	20	50	20	50	20	50	20	50	20	50		
Temperature °C																								
Hexane	▲	▲	■	■	■	■	■	▲	●	▲	■	▲	▲	▲	●	●	●	□	●	●	●	●		
Hydrobromic Acid (69%)	●	●	■	■	■	■	●	●	●	●	■	■	■	■	■	■	▲	▲	●	●	▲	▲		
Hydrochloric Acid (5%)	●	●	●	●	●	●	●	●	●	●	●	●	●	●	●	●	■	□	●	●	▲	▲		
Hydrochloric Acid (35%)	●	●	●	●	●	■	■	■	●	●	■	▲	●	●	●	■	▲	▲	●	●	▲	▲		
Hydrofluoric Acid (48%)	●	●	●	●	●	■	■	■	■	■	▲	▲	▲	▲	●	■	▲	▲	●	●	▲	▲		
Hydrogen Peroxide (30%)	●	●	●	●	●	■	■	■	●	●	●	●	●	■	●	●	■	▲	●	●	●	▲		
Lactic Acid (85%)	●	●	●	●	●	■	■	■	■	■	■	■	■	■	■	■	■	■	■	■	■	▲		
Methyl Acetate	●	▲	●	●	●	■	■	▲	▲	▲	▲	▲	▲	▲	▲	▲	▲	□	□	●	●	□	□	
Methyl Alcohol (Methanol)	●	■	●	●	●	●	●	■	●	●	■	■	■	■	▲	▲	▲	▲	●	●	●	●		
Methyl Ethyl Ketone (Butanone)	▲	▲	▲	▲	●	●	●	▲	▲	▲	▲	▲	▲	▲	▲	▲	▲	▲	▲	●	●	□	□	
Methylene Chloride (Dichloro Methane)	▲	▲	●	▲	●	▲	●	▲	▲	▲	▲	▲	▲	▲	▲	▲	▲	▲	▲	●	●	▲	▲	
Mineral Oil	■	●	●	●	●	■	■	■	●	●	●	●	●	●	●	●	●	●	●	●	●	●	●	
Nitric Acid (10%)	●	●	■	■	■	■	■	■	■	●	■	■	■	■	■	■	■	■	□	●	●	▲	▲	
Nitric Acid (70%)	●	▲	●	▲	▲	▲	●	▲	▲	▲	▲	▲	▲	▲	▲	▲	▲	▲	▲	●	●	▲	▲	
Nitrobenzene	▲	▲	▲	▲	▲	▲	●	▲	▲	▲	▲	▲	▲	▲	▲	▲	▲	▲	▲	●	●	■	▲	
Oxalic Acid (10%)	●	●	●	●	●	●	●	●	●	●	●	●	●	●	●	●	●	●	●	●	●	●	●	
Perchloric Acid (70%)	■	▲	■	▲	▲	▲	■	▲	■	▲	▲	▲	▲	▲	■	■	■	■	●	●	■	■	▲	▲
Phenol (100%)	▲	▲	▲	▲	▲	▲	▲	▲	▲	▲	▲	▲	▲	▲	▲	▲	▲	▲	▲	▲	●	●	▲	▲
Phosphoric Acid (85%)	●	▲	●	●	●	■	■	■	■	■	■	■	■	■	■	■	■	▲	●	●	●	▲		
Picric Acid	▲	▲	▲	▲	▲	▲	●	●	▲	▲	▲	▲	▲	■	■	●	●	□	□	●	●	□	□	
Potassium Hydroxide (30%)	●	●	●	●	●	●	●	●	●	●	▲	▲	■	■	●	●	●	●	●	●	●	●	●	
Potassium Permanganate	●	●	●	●	●	■	■	■	■	■	■	■	■	■	■	■	■	▲	●	●	■	■		
Propylene Glycol	●	●	●	●	●	●	●	●	■	■	■	■	●	●	●	●	□	□	●	●	●	●		
Pyridine	▲	▲	▲	▲	●	■	▲	▲	▲	▲	▲	▲	▲	▲	▲	▲	▲	▲	▲	●	●	■	■	
Salicylic Acid	●	●	●	●	●	●	●	■	■	●	■	●	■	●	■	□	□	●	●	▲	▲			
Silver Nitrate	●	■	●	●	●	●	●	●	■	●	●	●	●	●	■	□	□	●	●	■	■			
Sodium Hydroxide (50%)	■	■	●	●	●	●	●	●	●	▲	▲	●	■	●	■	■	■	▲	●	●	●	●		
Sodium Hypochlorite (15%)	●	■	●	■	■	▲	●	●	●	■	■	●	■	●	●	●	●	●	●	●	□	□		
Sulphuric Acid (20%)	●	●	●	●	●	●	●	●	■	●	■	●	●	●	■	■	■	■	●	●	□	□		
Sulphuric Acid (60%)	●	■	●	■	■	■	■	■	■	■	■	■	■	■	▲	▲	▲	▲	●	●	▲	▲		
Sulphuric Acid (98%)	■	■	■	■	■	●	■	■	■	▲	▲	▲	■	■	▲	▲	▲	▲	▲	●	●	▲	▲	
Tetrahydrofuran (THF)	■	▲	■	●	■	■	■	■	▲	▲	▲	▲	▲	▲	▲	▲	▲	▲	▲	●	●	■	■	
Toluene	■	▲	▲	▲	▲	▲	■	■	▲	▲	▲	▲	▲	▲	▲	▲	▲	▲	▲	●	●	▲	▲	
Trichloroacetic Acid	■	▲	■	▲	■	■	●	●	■	▲	■	▲	■	▲	▲	▲	▲	□	□	●	●	□	□	
Trichloroethylene	▲	▲	▲	▲	▲	▲	▲	▲	▲	▲	▲	▲	▲	▲	▲	▲	▲	▲	▲	●	●	▲	▲	
Turpentine	■	▲	■	▲	■	▲	■	■	■	■	■	■	■	■	■	■	■	▲	●	●	●	●		
Xylene	▲	▲	■	▲	▲	■	▲	▲	▲	▲	▲	▲	▲	▲	▲	▲	▲	▲	▲	●	●	●	●	
Zinc Chloride (10%)	●	●	●	●	●	●	●	●	●	●	●	●	●	●	●	●	●	●	●	●	●	●	■	
Zinc Sulphate (10%)	●	●	●	●	●	●	●	●	●	●	●	●	●	●	●	●	●	●	●	●	●	■	▲	

This chart gives general guidelines only on the chemical resistance of plastics. There are many factors that influence chemical resistance, we therefore recommend that you test for your own application before selecting the appropriate Azlon® product. If you have any doubts please contact SciLabware for assistance.

Care and maintenance of laboratory plasticware

The following guidelines are provided to ensure your plastic laboratory-ware is maintained in the best possible condition.

These guidelines are not definitive and care must be taken as each polymer has its own unique properties. Please also consult the chemical and physical properties charts in this catalogue. If you are still unsure e-mail azlon@scilabware.com for advice.



General Precautions

- Chemicals can adversely affect the performance of laboratory plasticware resulting in cracking, loss of strength and flexibility etc.

If in any doubt, note the type of polymer the product is manufactured from, the chemical that is to be used, then confirm compatibility by checking against the chemical resistance chart. (See pages xx - xx).

Washing and cleaning

- Most laboratory plasticware is readily cleaned in warm water with a detergent and soft cloth or sponge.

Avoid using abrasive cleaners or scouring pads which can result in surfaces becoming scratched.

- A low or non-alkaline detergent is suitable for cleaning most plasticware.

Note however that polystyrene and polycarbonate products are susceptible to attack by alkalis and a neutral detergent is recommended.

- If using an automatic laboratory washing machine to wash plastic volumetric ware, such as measuring cylinders, employ a wash temperature below 60°C. High temperatures can affect volumetric accuracy.

- Ultrasonic baths may be used for cleaning plasticware. However do take care that the products do not directly touch the transducer membrane.

Heating

- Never place plasticware in direct contact with a flame or place onto a hotplate surface.



- Most plastics allow the transmission of microwaves. However, as with any microwave vessel, be sure it holds a microwave absorbing material, such as water, before placing in the oven.



Sterilisation

- If the plasticware is to be sterilised by autoclaving always pre-check that the polymer can withstand repeated exposure to temperatures of 121°C. (See Physical Properties chart on page 18).

Azlon® plastic products that are autoclavable are identified by an *A* symbol in this catalogue.

- When autoclaving bottles always ensure the caps are loosened or removed to prevent accidental collapse or deformation.

Disposal

- If the disposal of an item of plasticware is unavoidable, always follow local laws and regulations.

Where reclamation facilities are offered it can be helpful to segregate the products by polymer type: many Azlon® products are marked with an SPI code to help identification.





Adapters, cone/screwthread



- With screwthread joint complete with plastic cap, silicone rubber ring and PTFE washer
- Ideal for securing thermometers, gas inlet tubes, etc.

Product Code	Thread size	Cone size	Acceptable dia. through screwcap mm	Pack qty.
ST51/13	13	14/23	6.0 - 7.0	2
ST51/18	18	14/23	7.0 - 8.5	2
ST52/13	13	19/26	6.0 - 7.0	2
ST52/18	18	19/26	7.0 - 8.5	2
ST52/24	24	19/26	10.5 - 11.5	2
ST53/13	13	24/29	6.0 - 7.0	2
ST53/18	18	24/29	7.0 - 8.5	2
ST53/24	24	24/29	10.5 - 11.5	2
ST54/13	13	29/32	6.0 - 7.0	2
ST54/18	18	29/32	7.0 - 8.5	2
ST54/24	24	29/32	10.5 - 11.5	2
ST54/28	28	29/32	18.0 - 19.0	1
ST55/28	28	34/35	18.0 - 19.0	1



i Spare plastic caps, rubber rings and PTFE washers are listed on page 202.

Adapters, expansion



- Useful for the connection of dissimilar sized ground glass joints
- Large sized socket at the top and small sized cone at the base

Product Code	Socket size	Cone size	Pack qty.
XA10	14/23	10/19	2
XA21	19/26	14/23	2
XA31	24/29	14/23	2
XA32	24/29	19/26	2
XA41	29/32	14/23	2
XA42	29/32	19/26	2
XA43	29/32	24/29	2
XA52	34/35	19/26	2
XA53	34/35	24/29	2
XA54	34/35	29/32	2
XA64	40/38	29/32	1
XA74	45/40	29/32	1
XA85	50/42	34/35	1





Adapters, reduction



- Useful for the connection of dissimilar sized ground glass joints
- Small sized socket at the top, large sized cone at the bottom

Product Code	Socket size	Cone size	Pack qty.
DA01	10/19	14/23	2
DA12	14/23	19/26	2
DA13	14/23	24/29	2
DA14	14/23	29/32	2
DA23	19/26	24/29	2
DA24	19/26	29/32	2
DA25	19/26	34/35	2
DA34	24/29	29/32	2
DA35	24/29	34/35	2
DA36	24/29	40/38	1
DA37	24/29	45/40	1
DA38	24/29	50/42	1
DA39	24/29	55/44	1
DA45	29/32	34/35	2
DA47	29/32	45/40	1
DA56	34/35	40/38	1
DA57	34/35	45/40	1
DA58	34/35	50/42	1



Adapters, Reduction, PTFE



- Useful for the connection of dissimilar sized ground glass joints, works with Quickfit®
- Excellent chemical resistance
- Operating temperature up to 260°C

Product Code	Socket	Cone	Pack qty.
SWN902	10/19	14/23	1
SWN908	19/26	34/35	1
SWN909	24/29	29/32	1
SWN911	29/32	34/35	1



Adapters, multiple, with two parallel necks



- With two parallel necks

Product Code	Socket size	Cone size	Pack qty.
MA1/11	14/23	14/23	1
MA1/2	19/26	19/26	1
MA1/3	19/26	24/29	1
MA1/33	24/29	24/29	1
MA1/44	29/32	29/32	1



Adapters, multiple, with two necks



- With two necks :
 - One vertical
 - One angled at 45°

Product Code	Socket size	Cone size	Pack qty.
MA2/2	19/26	19/26	1
MA2/3	19/26	24/29	1



Adapter, multiple, with three necks



- With three necks:
 - Two vertical
 - One at 45°

Product Code	Socket size vertical necks	Socket size angled neck	Cone size	Pack qty.
MA4/23	19/26	19/26	24/29	1





Adapters, swan neck



- With screwthread joint to accept thermometers and air leak tubes etc.

Product Code	Socket size	Cone size	Thread size	Pack qty.
MA6/22	19/26	19/26	13	1
MA6/33	24/29	24/29	13	1



Acceptable diameter of thermometer through the screwcap is 6 - 7mm. Spare plastic caps, rubber rings and PTFE washers are listed on page 202.



Adapters, receiver



- With short or long stem
- Useful for feeding distillate from condensers into receiving vessels

Product Code	Socket size	Approx stem length mm	Pack qty.
RA1/01	14/23	65	1
RA1/02	19/26	65	1
RA1/03	24/29	65	1
RA1/04	29/32	65	1
RA1/10	10/19	120	1
RA1/11	14/23	190	1
RA1/12	19/26	200	1
RA1/13	24/29	200	1
RA1/14	29/32	200	1



For plastic joint clips to secure glassware, please see page 194.



Adapters, receiver, straight type



- Straight type

Product Code	Socket size	Overall height mm	Pack qty.
RA1/22	19/26	180	1
RA1/23	24/29	180	1



Adapters, receiver, side socket



- With side socket inclined at an angle of 15° from horizontal

Product Code	Socket size	Cone size	Approx overall height (mm)	Pack qty.
RA4/11	14/23	14/23	120	1
RA4/22	19/26	19/26	120	1
RA4/23	19/26	24/29	120	1



Adapters, receiver, plain bend



- Plain bend without vent

Product Code	Socket size	Cone size	Approx overall height (mm)	Pack qty.
RA9/11	14/23	14/23	90	1
RA9/22	19/26	19/26	100	1
RA9/23	19/26	24/29	110	1
RA9/33	24/29	24/29	125	1
RA9/44	29/32	29/32	140	1



Adapters, receiver, bend with vent



- Bend with vent
- With side-arm to provide vent to atmosphere
- Avoids the problems of 'closed systems'

Product Code	Socket size	Cone size	Approx overall height (mm)	Pack qty.
RA2/11	14/23	14/23	80	1
RA2/22	19/26	19/26	106	1
RA2/23	19/26	24/29	120	1
RA2/33	24/29	24/29	130	1



The side-arm is for venting purposes and not for connection to a vacuum source. For adapters with vacuum connection, see RA3: and RA13: series.



Adapters, receiver, vacuum, angled



- Delivery stem within cone
- With side-arm for connection to a vacuum supply
- Easy connection to flexible tubing via detachable plastic screwthread connector

Product Code	Socket size	Cone size	Approx overall height (mm)	Pack qty.
RA3/11/SC	14/23	14/23	110	1
RA3/22/SC	19/26	19/26	140	1
RA3/23/SC	19/26	24/29	140	1
RA3/33/SC	24/29	24/29	150	1
RA3/44/SC	29/32	29/32	165	1

 For spare screwthread connectors, please refer to page 96.



Adapters, receiver, vacuum, straight



- Delivery stem within cone
- With side-arm for connection to a vacuum supply
- Easy connection to flexible tubing via detachable plastic screwthread connector

Product Code	Socket size	Cone size	Approx overall height (mm)	Pack qty.
RA13/33/SC	24/29	24/29	140	1



Adapters, receiver, pig



- Allows up to three flasks* to be connected to a condenser outlet
- Useful for collecting distillate fractions
- By slightly rotating the adapter a new flask is presented to the distillate
- With side-arm for connection to a vacuum supply

Product Code	Socket size	Cone size	Approx overall height (mm)	Pack qty.
RA5/11/SC	14/23	14/23	110	1
RA5/21/SC	19/26	14/23	110	1

 It is not dimensionally possible to fit large capacity flasks to these receivers.
*Maximum flask capacity is: RA5/11/SC - 50ml flask RA5/21/SC - 100ml flask.



Adapters, receiver, vacuum, four flask connector



- Allows four flasks to be connected to a condenser outlet
- Useful for collecting fractions when distilling under vacuum
- Each flask can be progressively filled by rotating the adapter
- Avoids problems of disturbing vacuum conditions when changing flasks
- Choice of collection flasks

Product Code	Description	Socket size	Cone size	Pack qty.
RA11/SC	Screwthread vacuum receiver adapter to take four flasks	19/26	14/23	1
RA12/2	Sloping delivery adapter	19/26	19/26	1
FR25/1S	25ml flask	14/23	-	5
FR50/1S	50ml flask	14/23	-	5
FR100/1S	100ml flask	14/23	-	5



i A choice of retaining clips to hold the flasks are detailed on page 194.

Adapters, receiver, Perkin



- For vacuum distillation work
- Allows receiver flasks to be changed without disturbing the vacuum within the system
- Fitted with 3 x GP Rotaflo® stopcocks with PTFE keys:
 - No lubrication required
 - No contaminating greases
 - No chemical corrosion
- With screwcap system for gentle release of vacuum at conclusion of work

Product Code	Capacity (ml)	Cone size	Socket size	Pack qty.
RA6/11/SC	10	14/23	14/23	1
RA6/22/SC	30	19/26	19/26	1
RA6/23/SC	30	24/29	19/26	1
RA6/33/SC	30	24/29	24/29	1



i Spare Rotaflo® keys are listed on page 241.



Adapters, splash head, vertical



- Usually inserted between a flask and condenser to prevent 'carry-over' of raw liquid

Product Code	Socket size	Cone size	Pack qty.
SH17/23	19/26	24/29	1



Adapters, splash head, sloping



- Popular adapter used in distillation assemblies to prevent raw liquid 'carrying over' from flask to condenser

Product Code	Cone size to fit flask	Cone size to fit condenser	Pack qty.
SH7/02	19/26	19/26	1
SH7/03	24/29	19/26	1
SH7/43	24/29	24/29	1
SH7/0/44	29/32	29/32	1



Adapters, splash head, vertical distillation



- A splash head for use in distillation assemblies in which the condenser is assembled in the vertical mode
 - Lower cone accepts flask, upper cone accepts condenser
 - Splash head reduces entrainment of raw liquid into the vapour stream

Product Code	Cone size to fit flask	Cone size to fit condenser	Pack qty.
SH7/12	19/26	19/26	1
SH7/13	24/29	19/26	1
SH7/53	24/29	24/29	1



Adapters, splash head, rotary evaporator, anti-climb



- For use with rotary evaporators
- Protects against liquid ingress into the condenser from 'bumping' solvents
- Useful for liquids that have tendency to foam
- Splash heads feature a 29/32 socket

Product Code	Cone size	Pack qty.
SH15/19	19/26	1
SH15/24	24/29	1
SH15/29	29/32	1



Adapters, splash head, rotary evaporator, with sinter



- For use with rotary evaporators
- Prevents possible contamination of condenser
- Features a coarse porosity 1 sinter to reduce carry over
- Splash heads feature a 29/32 socket

Product Code	Cone size	Pack qty.
SH16/19	19/26	1
SH16/24	24/29	1
SH16/29	29/32	1



Adapters, steam distillation head



- A splash-head with integral stem for the introduction of steam into flasks
- Stem is connected to steam supply via detachable screwthread safety connector

Product Code	Cone size to fit flask	Cone size to fit condenser	Pack qty.
SH7/23/SC	24/29	19/26	1



Screwthread connector, cat no: 4510/02, accepts 9mm bore flexible tubing. Spare screwthread connectors are available on page 96.





Adapters, still head



- Used in distillation assemblies for connecting flasks to condenser
- Upper socket designed to accept thermometer either via cone/screwthread adapter or thermometer pocket

Product Code	Cone size to fit flask	Cone size to fit condenser	Socket size	Pack qty.
SH4/0	10/19	10/19	10/19	1
SH4/1	14/23	14/23	14/23	1
SH4/22	19/26	19/26	14/23	1
SH4/2	19/26	19/26	19/26	1
SH4/23	24/29	19/26	14/23	1
SH4/33	24/29	24/29	14/23	1
SH4/24	29/32	19/26	14/23	1
SH4/44	29/32	29/32	14/23	1
SH4/55	34/35	34/35	14/23	1



Adapters, still head, Claisen



- Similar to the SH4: still heads but with extra socket to accept dropping funnel or stirrer etc.

Product Code	Cone size to fit flask	Cone size to fit condenser	Socket size	Pack qty.
SH6/1	14/23	14/23	14/23	1
SH6/22	19/26	19/26	14/23	1
SH6/23	24/29	19/26	14/23	1
SH6/33	24/29	24/29	14/23	1
SH6/44	29/32	29/32	14/23	1



PTFE joint sleeves eliminate the possibility of joint seizure, see page 193.



Adapters, still head, recovery



- Provides a simple vapour conduit between flasks and distillation condensers

Product Code	Cone size to fit flask	Cone size to fit condenser	Pack qty.
SH1/11	14/23	14/23	1
SH1/22	19/26	19/26	1
SH1/23	24/29	19/26	1
SH1/33	24/29	24/29	1
SH1/44	29/32	29/32	1



Adapters, still head, recovery, vertical mode



- Used in distillation assemblies in which the condenser is assembled in the vertical mode

Product Code	Cone size to fit flask	Cone size to fit condenser	Pack qty.
SH2/22	19/26	19/26	1
SH2/33	24/29	24/29	1





Adapters, Solvent still head



- Apparatus for distillation and collection of oxygen free solvents
- Solvent removed from the flask via
 - Top stopcock by syringe
 - Drainage through T-bore stockcock
- Drainage arm utilises a 14/23 Quickfit® cone

Product Code	Approx capacity ml	Approx height (mm)	Cone size	Socket size	Pack qty.
SH9/250	250	225	19/26	19/26	1
SH9/500	500	235	24/29	24/29	1
SH9/1L	1000	270	29/32	29/32	1

 Syringes should be purchased separately

 The use of solvent still heads involve the use of drying agents and generates hot solvents. Care should be taken when handling these potential hazards.



Adapters, stopcock, cone



- With GP Rotaflo® PTFE stopcock:
 - No lubrication required
 - No contaminating greases
 - Fine flow control
 - Positive closure
- Detachable plastic screwthread connectors allow rubber hose etc. to be fitted easily and safely

Product Code	Cone size	Stopcock bore mm	Pack qty.
MF11/1/SC	14/23	3.0	1
MF11/2/SC	19/26	3.0	1
MF11/3/SC	24/29	3.0	1
MF11/4/SC	29/32	3.0	1



 The detachable screwthread connectors accept flexible tubing having a bore of 9mm diameter - see page 96 for details.



Adapters, stopcock, T shape, cone



- With GP Rotaflo® PTFE stopcock providing fine flow control and positive closure
- Detachable plastic screwthread connectors allow rubber hose etc. to be fitted easily and safely

Product Code	Cone size	Stopcock bore mm	Pack qty.
MF11/1B/SC	14/23	3.0	1
MF11/2B/SC	19/26	3.0	1
MF11/3B/SC	24/29	3.0	1



The detachable screwthread connectors accept flexible tubing having a bore of 9mm diameter.



Adapters, stopcock, socket



- With GP Rotaflo® PTFE stopcock providing fine flow control and positive closure
- Detachable plastic screwthread connectors allow rubber hose etc. to be fitted easily and safely

Product Code	Socket size	Stopcock bore mm	Pack qty.
MF14/1/SC	14/23	3.0	1
MF14/2/SC	19/26	3.0	1
MF14/3/SC	24/29	3.0	1



The detachable screwthread connectors accept flexible tubing having a bore of 9mm diameter.



Adapters, tubing, right angle



- With right angle connection for attachment of rubber hose etc.
- Detachable plastic screwthread connectors allow flexible tubing to be fitted easily and safely

Product Code	Cone size	Pack qty.
MF10/1B/SC	14/23	1
MF10/2B/SC	19/26	1
MF10/3B/SC	24/29	1
MF10/4B/SC	29/32	1
MF10/5B/SC	34/35	1



For spare screwthread connectors, please see page 96.



Adapter, tubing, straight



- With straight connection for the attachment of rubber hose etc.
- Detachable plastic screwthread connectors allow flexible tubing to be fitted easily and safely

Product Code	Socket size	Pack qty.
MF13/2/SC	19/26	1
MF13/3/SC	24/29	1
MF13/4/SC	29/32	1

i Screwthread connector accepts rubber hose with a bore of 9mm.



Adapters, tubing, side-arm



- With side-arm for the attachment of rubber hose etc.
- Detachable plastic screwthread connector allows flexible tubing to be fitted easily and safely

Product Code	Socket size	Cone size	Pack qty.
MF17/1/SC	14/23	14/23	1
MF17/2/SC	14/23	19/26	1
MF17/3/SC	14/23	24/29	1
MF18/2/SC	19/26	19/26	1
MF18/3/SC	19/26	24/29	1
MF18/4/SC	19/26	29/32	1
MF18/5/SC	19/26	34/35	1
MF18/33/SC	24/29	24/29	1
MF18/44/SC	29/32	29/32	1



i For spare screwthread connectors, please see page 37.

Ampoule breakers, HDPE



- Enables safe and easy breaking of glass ampoules
- Broken ampoule top is retained for safe disposal
- Choice of size to suit all common glass ampoules

Product Code	Ampoule size	Pack qty.
AWY700	1 - 4 ml	1000
AWY702	5 - 10 ml	1000





Arsenic determination apparatus, aspirators



Arsenic determination apparatus

- Designed for the estimation of arsenic and antimony
- Method uses the formation of a complex between arsine and silver diethyldithiocarbamate with subsequent measurement at 5380A

Product Code	Description	Socket size	Cone size	Pack qty.
1AD/1	Complete Assembly	-	-	1
AD3	Absorption tube	-	24/29	1
FE100/3	100ml Erlenmeyer flask	24/29	-	5

i Reference: Elliot and Loper, *Analytical Chemistry*, (1974), 46, 2256.



Aspirator bottles, tubing side-arm

PYREX®

- Tubular side arm for attachment of 9mm bore flexible tubing
- Unground neck to accept rubber stoppers

Product Code	Capacity (ml)	Body diam. mm	Neck I.D.(at top) mm	Bottle height mm	Pack qty.
1531/06D	250	73	18	131	10
1531/08D	500	89	23	163	10
1531/10D	1000	111	28	200	5
1531/12D	2000	138	28	248	5



Aspirator bottles, ground glass side-socket

PYREX®

- Complies with ISO 4796
- Ground side socket (size 29/32) to accept stopcock assemblies
- Unground top neck to accept rubber stoppers

Product Code	Capacity (ml)	Body diam. mm	Neck I.D.(at top) mm	Bottle height mm	Pack qty.
1541/12D	2000	138	28	248	5
1541/16D	5000	181	44	318	1
1541/18D	10000	227	59	398	1
1541/20D	15000	258	59	460	1
1541/22D	20000	288	59	492	1

i Compatible with stopcocks on page 39.



Aspirator bottles, ground glass side-socket and neck

PYREX®

- Complies with ISO 4796
- Ground side socket (size 29/32) to accept stopcock assemblies
- Ground neck
- Supplied with glass stopper

Product Code	Capacity (ml)	Body diam. mm	Stopper size	Neck I.D. (at top) mm	Height with stopper	Pack qty.
1569/12DP	2000	138	29/32	29	262	2
1569/16D	5000	181	45/40	45	333	1
1569/18D	10000	227	60/46	60	414	1
1569/22D	20000	288	60/46	60	508	1



i Compatible with stopcocks as detailed below.

Aspirator stopcocks with ground cone

PYREX®

- For use with Aspirator bottles 1541: and 1569:
- Type 1568/04M with Rotaflo® PTFE key which is chemically inert and requires no lubrication
- Type 1571/02M with traditional glass key

Product Code	Stopcock bore mm	Cone size	Overall length mm	Pack qty.
1568/04M	3.0	29/32	53	1
1571/02M	4.0	29/32	95	1





Aspirator bottles, large capacity

PYREX®

- Ideal for storage of distilled water etc.
- Choice of sizes up to 20 litre capacity
- Wide neck with simple glass cover
- Supplied with plastic connector and rubber/PTFE sealing ring
- Accepts either stopcock GP6/10W or glass tubing of 14mm O.D.

Product Code	Capacity (ml)	Ext. neck diam. mm	Total height mm	Max. diam. mm	Pack qty.
1565/16M	5000	100	320	200	1
1565/18M	10000	127	395	234	1
1565/22M	20000	160	500	300	

i Aspirator and stopcock should be ordered separately.



Aspirator accessories and spares

PYREX®

- Stopcock for use with Aspirator Bottles 1565: series with Rotaflo PTFE key
- Essential spare connectors and sealing rings for 1565: series

Product Code	Description	Pack qty.
GP6/10W	10mm bore Aspirator Rotaflo stopcock	1
1548/02M	Spare plastic connector for outlet	1
1547/02M	Spare rubber/PTFE sealing ring	1



Aspirator, narrow neck, HDPE



- Large capacity aspirators with screw caps
- Ideal for bench-top dispensing of common solvents/distilled water etc. featuring smooth operating leak-proof stopcocks
- Good resistance to chemical attack

Product Code	Capacity litres	Neck I.D. mm	Overall height mm	Pack qty.
BGH034	5	49	330	1
BGH036	10	49	380	1
BGH038	25	80	580	1
BGH040	50	80	700	1

 Large carboys can be found on page 63.



Aspirator, narrow neck, HDPE, spares

Product Code	Description	Pack qty.
SWQ016	Spare stopcock for BGH034 & BGH036	1
SWQ003	Spare stopcock for BGH038 & BGH040	1

Aspirator, heavy duty, polypropylene



- Squat form for stable location on shelves, bench top or in transit
- Moulded handle for safe and secure carrying
- Clear moulded graduations allowing quick and easy volume assessment
- Leakproof heavy duty stopcock opens and closes in a quarter turn
- Autoclavable polypropylene for easy cleaning and sterilisation
- Caps have moulded drill guides for easy location of probes and feed-lines

Product Code	Capacity litres	Thread size mm	Max height x width mm	Pack qty.
BNP05A	5	45	270 x 220	1
BNP10A	10	90	360 x 280	1
BNP20A	20	90	420 x 350	1

 When autoclaving aspirators always ensure the caps are completely loosened or removed to prevent accidental implosion.

Aspirators, heavy duty, polypropylene, spares

Product Code	Description	Pack qty.
CAP/045H	Spare cap for BNP05A/B	1
CGZ85PP	Spare cap for BNP10A/B & 20A/B	1
SCBNP01	Spare stopcock	1



 Carboys can be found on page 63.



Aspirator, wide neck, HDPE



- Large capacity aspirator with easy fill wide aperture
- Screw cap with water tight rubber seal, leak-proof stopcock and carry handles
- Ideal for bench top dispensing of common laboratory liquids
- Good resistance to chemical attack

Product Code	Capacity litres	Neck I.D. mm	Height mm	Pack qty.
BGH068	30	240	415	1
BGH070	50	240	640	1
BWX072	100	240	770	1

i Spare stopcocks for this item - SWQ003 can be found on page 41.



Aspirator, square, HDPE



- Square shape saves space on benchtops and shelves
- Push-in water tight stopcock
- Graduated body
- 5 litre version features two moulded handles for safe transportation
- Larger sizes have a carry handle

Product Code	Capacity litres	Base mm	Neck I.D. mm	Height mm	Pack qty.
BSH05A	5	165	40	325	1
BSH10A	10	210	40	365	1
BSH20A	20	262	50	465	1
BSH30A	30	305	65	525	1

i Replacement stopcock: 4461/0010



Bags, autoclave, blue, polypropylene



- Suitable for autoclaving biohazardous waste at 121°C
- Strong side weld construction (50µm)
- Printed with instructions for use and biohazard symbol

Product Code	Size (mm)	Pack qty.
BWY200	300 x 608	100
BWY202	608 x 764	100
BWY204	608 x 896	100



Bags, autoclave, high temperature, clear, polypropylene



- Suitable for autoclaving biohazardous waste at 135°C
- Strong side weld construction (50µm)
- Transparent and printed with instructions for use and biohazard symbol

Product Code	Size (mm)	Pack qty.
BWY250	302 x 660	100
BWY252	433 x 632	100
BWY254	608 x 866	100



Balers, polypropylene



- Enables easy sampling of liquids
- A choice of 3 sampling volumes
- Supplied with 1m durable polypropylene coated steel handle
- Handle is screwed into beaker (13mm thread) via a welded coupling tube
- Units are autoclavable up to 121°C

Product Code	Capacity (ml)	Pack qty.
BWX016	250	1
BWX018	500	1
BWX020	1000	1





Basket, low form, polypropylene



- Strong lightweight rectangular basket
- Suitable for use as a draining / autoclave basket or for general storage
- Units stack when not in use to save space
- Good chemical resistance
- Autoclavable to 121°C

Product Code	I x w x h mm	Nom. Capacity ml	Pack qty.
TWR200	400 x 300 x 100	10000	1



Baskets, With hinged lid, polypropylene



- Autoclavable at 121°C
- Ideal for sterilising test tubes
- Useful for storage in the laboratory
- Stackable space saving design

Product Code	I x w x h mm	Pack qty.
BWK004	143 x 120 x 109	1
BWK006	167 x 167 x 155	1
BWK009	225 x 225 x 230	1



Pyrexcellence

In the world of laboratory glassware, all things are not created equal.

Take the Pyrex® heavy duty beaker for example. Made with 20% more borosilicate glass than a standard beaker, it has thicker walls, a heavier base and a reinforced rim and spout, making it significantly more resistant to impact fracture.

Pyrex® heavy duty beakers are also quality controlled for uniform thickness to give consistent, safe performance for years to come. The benefits to you - fewer breakages, fewer accidents, lower replacement costs.

To find out more about the best value for money glassware available, see page 47 in this catalogue.

PYREX® is a registered trademark of Corning Inc.

PYREX®

SciLabware Ltd., Beacon Road, Stone, Staffordshire, ST15 0SA UK
Tel: +44 (0)844 936 0231 Fax: (0)844 936 0232 www.scilabware.com

 **SciLabware**
AZLON® IJBL® PYREX® QUICKFIT®



Beakers, low form

PYREX®

- Complies with ISO 3819 and DIN 12331
- Manufactured from Pyrex® borosilicate glass
- Excellent thermal performance
- High resistance to chemical attack
- White graduations and marking spot

Product Code	Capacity (ml)	Height mm	O.D. mm	Pack qty.
1000/03M	5	30	22	10
1000/05M	10	35	26	10
1000/11M	25	50	34	10
1000/02M	50	60	42	10
1000/04D	100	70	50	10
1000/06D	150	80	60	10
1000/10D	250	95	70	10
1000/14D	400	110	80	10
1000/18D	600	125	90	10
1000/20D	800	135	100	10
1000/22D	1000	145	105	10
1000/28D	2000	185	130	10
1000/30D	3000	210	150	4
1000/34D	5000	270	170	1
1000/38D	10000	350	217	1

 1000/38D is supplementary to ISO range. Graduations are approximate.

LIPSOL® LABWARE DETERGENT

- Excellent cleaning performance - ideal for use with laboratory glassware and plasticware
- Great value for money
- Totally biodegradable

For full details see page 89





Beakers, low form, heavy duty

PYREX®

- Mechanically stronger than standard beakers
- Designed for longer life and increased user safety
- Reinforced rims and spout, less prone to breakage during washing etc.
- Thicker walls and heavier bases
- Manufactured from Pyrex® borosilicate glass
- White graduations and marking spot

Product Code	Capacity (ml)	Height mm	O.D. mm	Pack qty.
1003-150	150	89	57	12
1003-250	250	90	68	12
1003-400	400	110	77	12
1003-600	600	124	90	6
1003-1L	1000	156	108	6
1003-2L	2000	179	131	4
1003-3L	3000	230	170	1
1003-4L	4000	250	160	1
1003-5L	5000	300	180	1

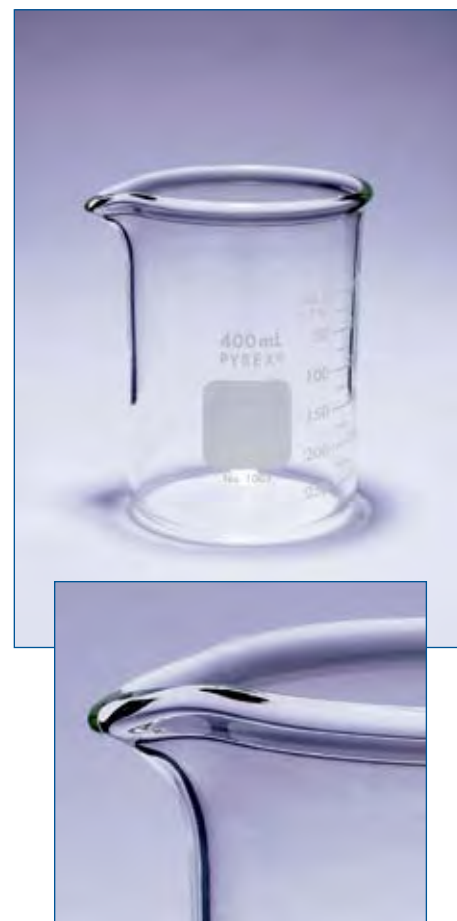

Graduations are approximate. For advice on the care and use of Pyrex® glassware, please refer to the technical information section.



The thicker walls of Pyrex® heavy duty beakers mean that care must be taken when heating and cooling.

Beakers, tall form

PYREX®

- Complies with ISO 3819 and DIN 12331
- Manufactured from Pyrex® borosilicate glass
- Tall form with spout
- White graduations and marking spot

Product Code	Capacity (ml)	Height mm	O.D. mm	Pack qty.
1015/02M	50	70	38	10
1015/04D	100	80	48	10
1015/06D	150	95	54	10
1015/10D	250	120	60	10
1015/14D	400	130	70	10
1015/18D	600	150	80	10
1015/22D	1000	180	95	10
1015/26D	2000	240	120	10



Graduations are approximate.



Beakers, conical form

PYREX®

- Conical shape (Phillips pattern) with spout
- Manufactured from Pyrex® borosilicate glass
- Excellent thermal performance and chemical resistance

Product Code	Capacity (ml)	Height mm	Base diam. mm	Top diam. mm	Pack qty.
1020/06D	250	105	68.0	52	10
1020/16D	500	142	86.0	59	10



Beakers, jacketed

PYREX®

- Useful for maintaining samples at a constant temperature
- With integral jacket through which a temperature controlling medium can be circulated
- Manufactured from heat resistant Pyrex® borosilicate glass
- With PTFE screwthread connectors for simple and safe connection of 9mm bore tubing

Product Code	Inner chamber capacity	Diam. ext mm	Diam. int mm	Height int mm	Height total mm	Pack qty.
1025/10SC	250	70	52	130	138	1
1025/18SC	600	95	70	170	180	1
1025/22SC	1000	110	80	215	235	1
1025/28SC	2000	130	106	260	280	1



For spare PTFE screwthread connectors, please refer to page 96. A range of jacketed reaction flasks are featured on page 151.



Beakers, straight sided, printed graduations, polypropylene



- Complies with ISO 7056
- Popular classic Azlon beakers
- Ideal for general laboratory use - straight stable shape
- Polypropylene material - good chemical resistance
- Can withstand temperatures up to 121°C and therefore autoclavable
- Graduations are clearly printed in indelible solvent resistant ink

Product Code	Capacity (ml)	Grads. ml	O.D. (mm)	Height mm	Pack qty.
BDA208P	10	1.0	32	32	10
BDA212P	25	2.0	42	40	10
BDA218P	50	5.0	51	51	10
BDA224P	100	10.0	62	62	10
BDA230P	250	25.0	82	82	10
BDA234P	400	50.0	94	95	10
BDA236P	500	50.0	93	101	10
BDA238P	600	50.0	106	107	5
BDA240P	1000	100.0	127	126	5
BDA242P	2000	200.0	158	160	1



i BDA234P and BDA238P are supplementary to ISO 7056.

Beakers, straight sided, printed graduations, polypropylene, sets



- Set of popular classic Azlon beakers
- Ideal for general laboratory use - straight stable shape
- Polypropylene material - good chemical resistance
- Can withstand temperatures up to 121°C and therefore autoclavable
- Graduations are clearly printed in indelible solvent resistant ink

Product Code	Description	Pack qty.
BDA218MES	Set of 3 beakers (50, 100 & 250ml)	1
BDA1198	Set of 3 beakers (500, 1000 & 2000ml)	1
BDA1199	Set of 5 beakers (10, 25, 50, 100 & 250ml)	1
BDA1200	Set of 8 beakers (10, 25, 50, 100, 250, 500, 1000 & 2000ml)	1
BDA300P	Set of 10 beakers (One of each size)	1



i BPB0400P, BPB0600P and BPB3000P are supplementary to ISO range.

Beakers, tapered, printed graduations, polypropylene



- Tapered stacking style - space saving and easy to handle
- Comply to ISO 7056
- High clarity polypropylene - autoclavable at 121°C with good chemical resistance
- Crisp, blue, easy to read indelible graduations
- Precise non drip pouring spouts

Product Code	Capacity (ml)	Grads. ml	Rim diam. mm	Height mm	Pack qty.
BPB0025P	25	5.0	41.5	51	10
BPB0050P	50	10.0	50.5	61	10
BPB0100P	100	20.0	61.5	73	10
BPB0250P	250	50.0	80.5	96	10
BPB0400P	400	50.0	92.5	111	10
BPB0500P	500	50.0	102.5	121	10
BPB0600P	600	50.0	104.0	126	5
BPB1000P	1000	100.0	120.0	148	5
BPB2000P	2000	200.0	163.0	188	1
BPB3000P	3000	200.0	172.0	214	1
BPB5000P	5000	500.0	230.0	250	1



i BPM0400P, BPM0600P and BPM3000P are supplementary to ISO range.

Beakers, tapered, moulded graduations, polypropylene



- Tapered Beaker allowing ease of handling
- Comply to ISO 7056
- Autoclavable at 121°C with good chemical resistance
- Stackable space saving design
- Made from high clarity polypropylene
- Durable and economical with clear, moulded permanent graduations
- Precise non drip pouring spouts

Product Code	Capacity (ml)	Grads. ml	Rim diam. mm	Height mm	Pack qty.
BPM0025P	25	5.0	41.5	51	10
BPM0050P	50	10.0	50.5	61	10
BPM0100P	100	20.0	61.5	73	10
BPM0250P	250	50.0	80.5	96	10
BPM0400P	400	50.0	92.5	111	10
BPM0500P	500	50.0	102.5	121	10
BPM0600P	600	50.0	104.0	126	5
BPM1000P	1000	100.0	120.0	148	5
BPM2000P	2000	200.0	163.0	188	1
BPM3000P	3000	200.0	172.0	214	1
BPM5000P	5000	500.0	230.0	250	1



Beakers, straight sided, printed graduations, PMP (TPX)



- Complies to ISO 7056
- Popular classic Azlon® beakers
- Ideal for general laboratory use
- Straight sided and stable
- PMP material with excellent chemical resistance
- Can withstand temperatures up to 180°C and therefore autoclavable
- Graduations are clearly printed in indelible solvent resistant ink

Product Code	Capacity (ml)	Grads. ml	O.D. (mm)	Height mm	Pack qty.
BDB312P	25	2.0	42	40	10
BDB318P	50	5.0	51	51	10
BDB324P	100	10.0	62	62	10
BDB330P	250	25.0	82	82	5
BDB334P	400	50.0	94	95	5
BDB336P	500	50.0	93	101	5
BDB338P	600	50.0	106	107	5
BDB340P	1000	100.0	127	126	1
BDB342P	2000	200.0	158	160	1



i BDB334P and BDB338P are supplementary to ISO 7056.

Beakers, straight sided, PTFE



- Opaque PTFE beakers
- Rigid and non-porous with a smooth surface
- Resistant to all chemicals except molten alkali metals and fluorine
- Are efficient substitutes for platinum
- Can withstand temperatures up to 260°C

Product Code	Capacity (ml)	O.D. (mm)	Height mm	Pack qty.
BWN008	10	24	33	1
BWN012	25	32	47	1
BWN018	50	43	60	1
BWN024	100	54	68	1
BWN030	250	66	97	1
BWN036	500	80	125	1



It is NOT advisable to use PTFE beakers on a hotplate as fluorine can be emitted at high temperatures.



Disposal bins, cardboard & LDPE



- Self assembly rigid boxes for safe disposal of broken glass
- Glass is safely held in strong leak-proof and puncture resistant LDPE liner
- Lid has an integral waste flap for easy use and has a sealing feature for use when full
- Boxes are clearly printed with instructions for use

Product Code	Description	Dimensions (w x d x h) cm	Pack qty.
DBG001P	Glass bin floor standing	30 x 30 x 70	6
DBG002P	Glass bin bench top	23 x 23 x 26.5	6



Incineration bins, cardboard & LDPE



- Self-assembly rigid boxes for the collection and incineration of biohazardous waste
- Waste is safely held in strong leak-proof and puncture resistant LDPE liner
- Lid has an integral waste flap for easy use and has a sealing feature for use when full
- Boxes are clearly printed with instructions for use

Product Code	Description	Dimensions (w x d x h) cm	Pack qty.
DBH001P	Incineration bin floor standing	30 x 30 x 70	6
DBH002P	Incineration bin bench top	20 x 20 x 25	6



Bottles, media-lab, with cap and pouring ring

PYREX®

- Bottles complete with polypropylene cap and drip-free pouring ring
- Complies with ISO 4796
- Printed with retrace code: downloadable batch certificate
- Ideal for mixing and storage of culture medium
- Sloping shoulders for smooth pouring action
- White graduations and marking spot
- Manufactured from temperature and chemically resistant borosilicate glass
- For use up to 140°C

Product Code	Capacity (ml)	Bottle height mm	Body diam. mm	Thread size mm	Pack qty.
1516/01D	25	70	36	25	10
1516/02D	50	88	46	32	10
1516/04D	100	100	56	45	10
1516/06D	250	138	70	45	10
1516/08D	500	176	86	45	10
1516/10D	1000	225	101	45	10
1516/12D	2000	260	136	45	10
1516/16D	5000	330	181	45	1
1516/18D	10000	410	227	45	1
1516/20D	15000	465	258	45	1
1516/22D	20000	510	300	45	1



i The 25 ml size bottle features a glass lip and does not require a pouring ring.

! Never autoclave bottles with a fully tightened screwcap. Always slacken off. Failure to follow this procedure can lead to breakage of the bottle.

i Further information on 'retrace codes' is detailed in the technical information section.

Bottles, media-lab, with high temp cap and pouring ring

PYREX®

- As 1516: bottles but with thermoplastic polyester cap and pouring ring
- Printed with retrace code: downloadable batch certificate
- Withstands hot air sterilisation up to 180°C
- PTFE sealing disc resists chemical attack

Product Code	Capacity (ml)	Bottle height mm	Body diam. mm	Thread size mm	Pack qty.
1516/01Red	25	70	36	25	10
1516/02Red	50	88	46	32	10
1516/04Red	100	100	56	45	10
1516/06Red	250	138	70	45	10
1516/08Red	500	176	86	45	10
1516/10Red	1000	225	101	45	10
1516/12Red	2000	260	136	45	10
S/31516/16D	5000	330	181	45	1
S/31516/18D	10000	410	227	45	1



i The 25 ml size bottle features a glass lip and does not require a pouring ring.



Choice of caps and pouring rings available separately on pages 56-57.

Bottles, media-lab, without cap or pouring ring

PYREX®

- Glass bottles only
- As Pyrex 1516: range but supplied without cap or pouring ring
- Printed with retrace code: downloadable batch certificate

Product Code	Capacity (ml)	Bottle height mm	Body diam. mm	Thread size mm	Pack qty.
1517/01	25	70	36	25	10
1517/02	50	88	46	32	10
1517/04	100	100	56	45	10
1517/06	250	138	70	45	10
1517/08	500	176	86	45	10
1517/10	1000	225	101	45	10
1517/12	2000	260	136	45	10
1517/16	5000	330	181	45	1
1517/18	10000	410	227	45	1
1517/20	15000	465	258	45	1
1517/22	20000	510	300	45	1



Never autoclave bottles with a fully tightened screwcap. Always slacken off. Failure to follow this procedure can lead to breakage of the bottle.



Bottles, media-lab, plastic-coated

PYREX®

- Bottles only. Supplied without cap or pouring ring
- Borosilicate glass with clear plastic coating to provide added protection against mechanical breakage
- Reduces the hazard of flying glass and liquid splashes in the event of breakage
- Printed with retrace code: downloadable batch certificate
- Coating withstands steam sterilisation up to 135°C

Product Code	Capacity (ml)	Bottle height mm	Body diam. mm	Thread size mm	Pack qty.
1518/04	100	100	56	45	10
1518/06	250	138	70	45	10
1518/08	500	176	86	45	10
1518/10	1000	225	101	45	10
1518/12	2000	260	136	45	10
1518/16	5000	330	181	45	1
1518/18	10000	410	227	45	1



For further details on plastic coated-bottles, please see the technical information section.



Bottles, media-lab, amber glass

PYREX®

- Bottles only. Supplied without cap or pouring ring
- Manufactured from amber-coated borosilicate glass
- UV absorbent up to 500nm
- Ideal for storage of light sensitive materials
- Printed with retrace code: downloadable batch certificate

Product Code	Capacity (ml)	Bottle height mm	Body diam. mm	Thread size mm	Pack qty.
1519/01	25	70	36	25	10
1519/02	50	88	46	32	10
1519/04	100	100	56	45	10
1519/06	250	138	70	45	10
1519/08	500	176	86	45	10
1519/10	1000	225	101	45	10
1519/12	2000	260	136	45	10
1519/16	5000	330	181	45	1
1519/18	10000	410	227	45	1



1519: Amber media bottles also available with polypropylene or High temperature cap and pouring ring. Please contact SciLabware customer service department for details.

Bottles, media-lab, square shape

PYREX®

- Square shape allows closer stacking in water baths or on shelves
- Up to 20% saving of space compared to round bottles
- Bottle complete with polypropylene cap and pouring ring
- For use up to 140°C
- Printed with retrace code: downloadable batch certificate

Product Code	Capacity (ml)	Bottle height mm	Body diam. mm	Thread size mm	Pack qty.
1520/04D	100	109	50	32	10
1520/06D	250	143	64	45	10
1520/08D	500	181	78	45	10
1520/10D	1000	222	94	45	10



Further information on 'retrace codes' is detailed in the technical information section.



Screwcaps for media-lab bottles

PYREX®

- For use with 1516, 1517, 1518, 1519 and 1520 series bottles
- Polypropylene plug seal cap ideal for media preparation work
- Autoclavable up to 140°C
- Available in choice of 4 colours for easy identification of samples

Product Code	Thread size mm	Colour	Pack qty.
4506/25D	25	Light blue	10
4506/32D	32	Light blue	10
4506/45D	45	Light blue	10
4506/45E	45	Green	10
4506/45F	45	Yellow	10
4506/45G	45	Grey	10



Screwcaps for media-lab bottles, high temperature

PYREX®

- For use with 1516, 1517, 1518, 1519 and 1520 series bottles
- Ideal for applications involving high temperatures or aggressive chemicals
- Thermoplastic polyester cap with PTFE faced sealing disc
- Withstands hot air sterilisation up to 180°C
- PTFE sealing disc resists chemical attack

Product Code	Thread size mm	Colour	Pack qty.
4526/25D	25	Red	10
4526/32D	32	Red	10
4526/45D	45	Red	10



The cap may discolour when used at the maximum temperature of 180°C, however this does not affect performance.



Pouring rings for media-lab bottles

PYREX®

- For use with 1516, 1517, 1518, 1519 and 1520 series bottles
- Ensures drip-free pouring
- Clear polypropylene pouring ring
- Withstands autoclaving up to 140°C

Product Code	Thread size mm	Colour	Pack qty.
4516/32D	32	Clear	10
4516/45D	45	Clear	10



Pouring rings for media-lab bottles, high temperature

- For use with 1516, 1517, 1518, 1519 and 1520 series bottles
- Ideal for applications involving high temperatures
- Red coloured ethylene-tetrafluoroethylene pouring ring
- Withstands hot air sterilisation up to 180°C

Product Code	Thread size mm	Colour	Pack qty.
4536/32D	32	Red	10
4536/45D	45	Red	10

PYREX®



Bottles, reagent, screwcap

- Complies with ISO 4796-1
- Ideal for storage of reagents, analytical standards and culture media etc.
- Manufactured from Pyrex® borosilicate glass
- Excellent resistance to chemical attack and high temperatures
- Supplied with phenolic screwcaps having a PTFE faced sealing disc
- Autoclavable up to 121°C
- White graduations and marking spot

Product Code	Capacity (ml)	Bottle height mm	Body diam. mm	Thread size mm	Pack qty.
1515/01D	25	65	35	20	10
1515/02D	50	80	43	25	10
1515/04D	100	105	53	25	10
1515/06D	250	135	66	30	10
1515/08D	500	175	81	30	10
1515/10D	1000	215	101	42	10
1515/12D	2000	245	136	60	10
1515/16D	5000	324	181	60	1
1515/18D	10000	395	227	60	1
1515/20D	15000	460	258	60	1
1515/22D	20000	502	288	60	1

PYREX®



Never autoclave bottles with a fully tightened cap. Always slacken off. Failure to follow this procedure can lead to breakage of the bottle.



Screwcaps for 1515: series reagent bottles

PYREX®

- Phenolic cap with PTFE faced sealing disc for chemical resistance
- Autoclavable up to 121°C

Product Code	Description	Thread size mm	Pack qty.
4503/20	Cap with insert	20	20
4503/25	Cap with insert	25	20
4503/30	Cap with insert	30	20
4503/42	Cap with insert	42	10
4503/60	Cap with insert	60	5
4513/20M	Spare insert	20	20
4513/25M	Spare insert	25	20
4513/30M	Spare insert	30	20
4513/42M	Spare insert	42	10
4513/60M	Spare insert	60	5

 *Insert is ethylene propylene with PTFE face for chemical resistance.*



Bottles, reagent, narrow neck, glass stopper

PYREX®

- Complies with ISO 4796-2
- Borosilicate glass with ground neck
- Supplied with solid glass stopper

Product Code	Capacity (ml)	Body diam. mm	Stopper size	Height with stopper mm	Pack qty.
1521/04D	100	54	14/15	106	10
1521/06D	250	73	19/26	143	10
1521/08D	500	89	24/29	175	10
1521/10D	1000	111	29/32	214	10
1521/12D	2000	138	29/32	262	10
1521/16D	5000	181	45/40	333	1
1521/18D	10000	227	60/46	414	1
1521/22D	20000	288	60/46	508	1

 *Spare glass stoppers are available on page 249.*



Bottles, reagent, narrow neck

PYREX®

- Complies with ISO 4796
- Borosilicate glass with unground neck
- For use with rubber stoppers (not supplied)

Product Code	Capacity (ml)	Body diam. mm	Neck I.D. at top mm	Bottle height mm	Pack qty.
1526/04D	100	54	13	95	10
1526/06D	250	73	18	131	10
1526/08D	500	89	23	163	10
1526/10D	1000	111	28	200	10
1526/12D	2000	138	28	248	10
1526/16D	5000	187	44	315	1
1526/18D	10000	227	59	398	1
1526/20D	15000	258	59	460	1
1526/22D	20000	288	59	492	1



i 1526/20D is supplementary to the ISO range.

Bottles, density, adjusted

MBL®

- Complies with ISO 3507, Gay-Lussac type
- Adjusted ready for use - with the exact volume engraved on the bottle
- With individual capillary stoppers which are numbered and matched with the bottle
- Manufactured from Pyrex® borosilicate glass

Product Code	Nom. capacity ml	Tol. ± ml	Pack qty.
BRE000	10	1.00	2
BRE002	25	2.00	2
BRE004	50	3.00	2
BRE006	100	3.00	2





Bottles, roller

PYREX®

- Ideal for cell culture work
- Pyrex® borosilicate glass, specially selected for surface finish and optical clarity
- Wide neck for easy cell harvesting
- Non-toxic polypropylene screwcap
- Autoclavable up to 121°C
- Fits standard roller apparatus

Product Code	Overall length mm	Body O.D. mm	Effective length mm	Effective growth area	Overall growth area	Pack qty.
1528/02	284	110	210	670	820	2



Never autoclave bottles with a fully tightened screwcap. Always slacken off. Failure to follow this procedure can lead to breakage of the bottle.



Bottles, dropping

MBL®

- Borosilicate glass bottle and pipette.
- Polypropylene stopper
- Pipette fitted with vinyl rubber teat

Product Code	Capacity (ml)	O.D. mm	Bottle height mm	Pack qty.
BRF056	100	54	104	10



Bottles, round, narrow neck, polypropylene



- Translucent, rigid polypropylene bottles with polypropylene screw caps
- Heavy duty and very durable in use
- Autoclavable at 121°C
- Ideal for a wide range of liquid storage, media preparation and sampling applications
- Good general chemical resistance

Product Code	Capacity (ml)	Height mm	O.D. (mm)	Neck I.D. mm	Pack qty.
BNP0030PN	30	66	32	17	10
BNP0060PN	60	79	40	17	10
BNP0100PN	100	89	50	22	10
BNP0125PN	125	102	50	22	10
BNP0150PN	150	116	50	22	10
BNP0250P	250	140	60	22	10
BNP0500P	500	160	75	22	10
BNP1000P	1000	201	90	22	5
BNP2000P	2000	238	120	34	5



When autoclaving bottles always ensure the caps are completely loosened or removed to prevent accidental implosion.

Bottles, round, wide neck, polypropylene



- Translucent, rigid polypropylene bottles with polypropylene screw caps
- Screw caps have non-stick feature and open and close in less than 1½ turns
- Heavy duty and very durable in use
- Ideal for a wide range of liquid storage, media preparation and sampling applications
- Good chemical resistance
- Autoclavable at 121°C

Product Code	Capacity (ml)	Height mm	O.D. (mm)	Neck I.D. mm	Pack qty.
BWP0030PN	30	70	32	22	10
BWP0060PN	60	82	40	22	10
BLP0100P	100	86	50	32	10
BLP0125P	125	100	50	32	10
BLP0150P	150	113	50	32	10
BWP0250P	250	141	60	34	10
BWP0500P	500	161	75	44	10
BWP1000P	1000	207	90	53	5
BWP2000P	2000	243	120	53	5



When autoclaving bottles always ensure the caps are completely loosened or removed to prevent accidental implosion.



Bottles, round, wide neck, amber, polypropylene



- Opaque, rigid amber polypropylene bottles with black polypropylene screw caps
- Ideal for a wide range of light sensitive liquid or solid storage
- Screw caps have non-stick feature and open or close easily in less than 1½ turns
- Heavy-duty and very durable in use
- Autoclavable at 121°C
- Good general chemical resistance

Product Code	Capacity (ml)	Height mm	O.D. (mm)	Neck I.D. mm	Pack qty.
BWP0060AP	60	84	40	22	10
BWP0150AP	150	104	50	32	10
BWP0250AP	250	141	60	34	10
BWP0500AP	500	161	75	44	10
BWP1000AP	1000	207	90	53	5
BWP2000AP	2000	243	120	53	5



For information on chemical resistance please refer to the chemical resistance chart in the technical section.



When autoclaving bottles always ensure the caps are completely loosened or removed to prevent accidental implosion.



Bottles, graduated, write-on-panel, polypropylene



- High clarity polypropylene bottles with good chemical resistance
- Clear crisp printed graduations show millilitres and fluid ounces
- Printed with large white write-on-panel for easy labelling
- Wide mouth bottle
- Ideal for both liquids and solids, perfect for microbiological sampling
- Autoclavable at 121°C
- Reference code detailed on the bottle for easy replacement ordering

Product Code	Capacity (ml)	Height mm	O.D. mm	Neck I.D. mm	Pack qty.
BWP0060PGRAD	60	82	40	22	10
BLP0125PGRAD	125	100	50	32	10
BWP0250PGRAD	250	141	60	34	10
BWP0500PGRAD	500	161	75	44	10
BWP1000PGRAD	1000	207	90	53	5



When autoclaving bottles always ensure the caps are completely loosened or removed to prevent accidental implosion.



Bottles, carboy, heavy duty, polypropylene

- Good general chemical resistance
- Squat form for easy location on shelves, bench top or in transit
- Moulded handle for safe and secure carrying
- Moulded graduations for quick easy volume reference
- Autoclavable at 121°C
- Caps on 10 & 20 litre carboys have moulded drill guides to aid installation of feed-lines etc.

Product Code	Capacity litres	Thread size mm	Max height x width mm	Pack qty.
BNP05B	5	45	270 x 220	1
BNP10B	10	90	360 x 280	1
BNP20B	20	90	420 x 350	1

 Aspirators can be found on page 38.

 When autoclaving bottles always ensure the caps are completely loosened or removed to prevent accidental implosion.



Bottles, carboy, heavy duty, polypropylene, spares

Product Code	Description	Pack qty.
CAP045/H	Spare cap for BNP05A/B	
CGZ85PP	Spare cap for BNP10A/B & 20A/B	1

Bottles, carboy, large, narrow neck, HDPE

- Large capacity bottles with screw cap
- Ideal for bulk storage or transport of liquids
- Fitted with carrying handle (except 5L carboy)
- Good resistance to chemical attack

Product Code	Capacity litres	Neck I.D. mm	Overall height mm	Pack qty.
BGH022	5	49	330	1
BGH024	10	49	380	1
BGH026	25	80	580	1
BGH028	50	80	700	1

 Large aspirators can be found on page 42.





Bottles, carboy, square, HDPE



- Square shape saves space on benchtops and shelves
- Graduated body
- 5 litre version features two moulded handles for safe transportation
- larger sizes have a carry handle

Product Code	Capacity litres	Base mm	Neck I.D. mm	Height mm	Pack qty.
BSH05B	5	165	40	325	1
BSH10B	10	210	40	365	1
BSH20B	20	262	50	465	1
BSH30B	30	305	65	525	1



Bottles, round, narrow neck, HDPE



Azlon

- Translucent, rigid HDPE bottles with polypropylene screw caps
- Lightweight but very durable in use
- Ideal for storing a wide range of liquids

Product Code	Capacity (ml)	Height mm	O.D. (mm)	Neck I.D. mm	Pack qty.
BNH0030PN	30	66	32	17	10
BNH0060PN	60	79	40	17	10
BNH0100PN	100	89	50	22	10
BNH0125PN	125	102	50	22	10
BNH0150PN	150	116	50	22	10
BNH0250P	250	140	60	22	10
BNH0500P	500	160	75	22	10
BNH1000P	1000	201	90	22	5
BNH2000P	2000	238	120	34	5



For further information on chemical comparability see the chemical resistance chart in the technical section.



Bottles, round, wide neck, HDPE



Azlon

- Translucent, rigid HDPE bottles with polypropylene screw caps
- Screw caps have non-stick feature and open and close in less than 1½ turns
- Heavy duty and very durable in use
- Ideal for a wide range of liquid storage, media preparation and sampling applications
- Good chemical resistance

Product Code	Capacity (ml)	Height mm	O.D. (mm)	Neck I.D. mm	Pack qty.
BWH0030PN	30	70	32	22	10
BWH0060PN	60	82	40	22	10
BLH0100P	100	86	50	32	10
BLH0125P	125	100	50	32	10
BLH0150P	150	113	50	32	10
BWH0250PN	250	141	60	34	10
BWH0500PN	500	161	75	44	10
BWH1000PN	1000	207	90	53	5
BWH2000P	2000	243	120	53	5



Bottles, round, powder, wide neck, HDPE



Azlon

- Translucent rigid HDPE bottles with PVDC wadded polypropylene screw caps
- Ideal for storage of powders and other solids

Product Code	Capacity (ml)	Height mm	O.D. (mm)	Neck I.D. mm	Pack qty.
BGC428P	150	104	50	26	10
BGC430P	250	124	61	48	10
BGC432P	300	135	61	48	10
BGC436P	500	154	74	48	10
BGC440P	1000	190	98	72	5





Bottles, square, wide neck, wadded, HDPE



Azlon

- Heavy duty wide neck bottles
- Black polypropylene with LDPE foam wad
- Practical square design for economic use of space
- Designed for chemical, powder or granule storage

Product Code	Capacity (ml)	Base x height mm	Neck I.D. mm	Pack qty.
BGE424P	100	47 x 74	33	10
BGE426P	125	47 x 89	33	10
BGE430P	250	60 x 106	43	10
BGE436P	500	72 x 127	52	10
BGE439P	1000	95 x 171	58	5
BGE441P	1500	101 x 184	58	5



Bottles, square, graduated, wide neck, HDPE



Azlon

- Heavy duty square bottles with plug seal and screw cap
- Easy to grip caps have toggle for tamper evident wire attachment to neck
- Moulded graduations for approximate volume measurement
- Suitable for liquid or solid usage
- Food safe
- Space saving design

Product Code	Capacity (ml)	Neck I.D. mm	l x w x h mm	Pack qty.
BGE212P	25	18	32 x 32 x 51	10
BGE218P	50	24	36 x 36 x 68	10
BGE224P	100	34	48 x 45 x 88	10
BGE230P	250	34	60 x 56 x 108	10
BGE336P	500	44	80 x 67 x 135	10
BGE340P	1000	58	101 x 82 x 170	5
BGE342P	2000	58	130 x 98 x 215	5



For information on food safety, please refer to the technical section.



Bottles, square, graduated, coloured cap, wide neck, HDPE



Azlon

- Lightweight square bottles with plug seal and blue screw cap
- Moulded graduations for approximate volume measurement
- Ideal for powders
- Space saving design
- Neck I.D. 58mm

Product Code	Capacity (ml)	l x w x h mm	Pack qty.
BGE236P	500	75 x 75 x 120	10
BGE240P	1000	94 x 75 x 180	5
BGE242P	2000	108 x 92 x 235	5



Bottles, round, slope shoulder, narrow neck, LDPE



Azlon

- Flexible and translucent lightweight bottles
- Suitable for liquids
- Slope shoulder for smooth pouring
- Supplied capped with 28R4 polypropylene screw cap
- Neck I.D. 21mm

Product Code	Capacity (ml)	Diam. x height mm	Pack qty.
BGK930P	250	54 x 152	10
BGK936P	500	69 x 187	10
BGK940P	1000	84 x 246	5



Bottles, round, narrow neck, LDPE



Azlon

- Translucent, flexible LDPE bottles with polypropylene screw caps
- Heavy duty and very durable in use
- Ideal for a wide range of liquid storage/media preparation and sampling applications
- Good general chemical resistance

Product Code	Capacity (ml)	Height mm	O.D. (mm)	Neck I.D. mm	Pack qty.
BNL0030PN	30	66	32	17	10
BNL0060PN	60	79	40	17	10
BNL0100PN	100	89	50	22	10
BNL0125PN	125	102	50	22	10
BNL0150PN	150	116	50	22	10
BNL0250P	250	140	60	22	10
BNL0500P	500	160	75	22	10
BNL1000P	1000	201	90	22	5
BNL2000P	2000	238	120	34	5





Bottles, dispensing, pivot nozzle, LDPE



Azlon

- Round LDPE bottles fitted with a pivoting nozzle closure
- Nozzle retracts into cap to seal bottle
- Suitable for use as a dropping or wash bottle and excellent for dispensing gels
- Good resistance to chemical attack

Product Code	Capacity (ml)	O.D. (mm)	Height mm	Pack qty.
BGE514P	30	32	84	10
BGE520P	60	39	94	10
BGE528P	150	59	120	10
BGE530P	250	59	145	10
BGE536P	500	74	174	10



Bottles, dispensing, spouted cap, LDPE



Azlon

- Round LDPE bottles fitted with spouted dropper closure
- Closure features a captive sealing cap and can be cut to adjust flow rate
- Suitable for use as a dropping or dispensing bottle
- Good resistance to chemical attack

Product Code	Capacity (ml)	Diam. x height mm	Cap size	Pack qty.
BGE814PNC	30	32 x 103	28R4	10
BGE820PNC	60	39 x 118	28R4	10
BGE828PNC	150	50 x 144	28R4	10
BGE830PNC	250	60 x 168	28R4	10
BGE836PNC	500	73 x 198	28R4	10



Bottles, round, wide neck, PTFE



- Opaque PTFE bottles
- Rigid and non-porous with a smooth surface
- Resist all chemicals except molten alkali metals and fluorine
- Slope shoulder for easy pouring of powders or liquids
- Can withstand temperatures upto 260°C

Product Code	Capacity (ml)	Diam. x height mm	Neck I.D. mm	Pack qty.
BWN118	50	43 x 76	25	1
BWN124	100	52 x 88	35	1
BWN130	250	67 x 115	42	1



Do not use when sealed for chemical reactions or digestions.
Loosen lids when thermally sterilising.

Bottles, wash, multi-lingual, safety venting, wide neck, LDPE



- Multi-lingual wide neck wash bottles featuring the patented DripLok® vapour venting valve that prevents solvent drips
- Indelibly printed in 4 languages (English, French, German and Spanish)
- Choose from five solvent labels all including the new Globally Harmonised Symbols, NFPA diamond, risk phrases and safety information
- Fitted with colour coded one-piece PP closures that maintain their shape in use
- Closures feature precision jet-tip aperture for fine control

Product Code	Capacity (ml)	Print label	Closure colour	Pack qty.
WGW531VTML	250	Acetone	Red	5
WGW535VTML	250	Ethanol	Orange	5
WGW534VTML	250	I.M.S	Yellow	5
WGW533VTML	250	Isopropanol	Blue	5
WGW532VTML	250	Methanol	Green	5
WGW537VTML	500	Acetone	Red	5
WGW541VTML	500	Ethanol	Orange	5
WGW540VTML	500	I.M.S	Yellow	5
WGW539VTML	500	Isopropanol	Blue	5
WGW538VTML	500	Methanol	Green	5

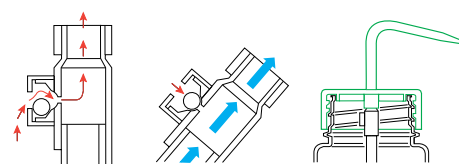



Bottles



Bottles, wash, safety venting, DIY, wide neck, LDPE



- Do-it-yourself DripLok® wash bottles with blank write-on-panel
- Indelibly printed in 3 languages (English, French and German)
- Supplied with adhesive hazard labels

Product Code	Description	Pack qty.
WGW001VTML	250ml Custom/DIY with white cap	5
WGW002VTML	500ml Custom/DIY with white cap	5
WGW020VTML	1000ml Custom/DIY with white cap	5
WGWPEN01	Indelible black marker pen for custom/DIY wash bottles	2



Bottles, wash, multi-lingual, non-venting, wide neck, LDPE



- Multi-lingual wide neck wash bottles
- Indelibly printed in 4 languages (English, French, German and Spanish)
- Choose from three water or five solvent labels all including the new Globally Harmonised Symbols, NFPA diamond, risk phrases and safety information
- Fitted with colour coded one-piece PP closures that maintain their shape in use
- Closures feature precision jet-tip aperture for fine control

Product Code	Capacity (ml)	Print label	Closure colour	Pack qty.
WGW600PML	250	Distilled water	White	5
WGW602PML	250	Deionised water	White	5
WGW530PML	250	Water	White	5
WGW531PML	250	Acetone	Red	5
WGW532PML	250	Methanol	Green	5
WGW533PML	250	Isopropanol	Blue	5
WGW534PML	250	I.M.S	Yellow	5
WGW535PML	250	Ethanol	Orange	5
WGW536PML	500	Water	White	5
WGW601PML	500	Distilled water	White	5
WGW603PML	500	Deionised water	White	5
WGW537PML	500	Acetone	Red	5
WGW538PML	500	Methanol	Green	5
WGW539PML	500	Isopropanol	Blue	5
WGW540PML	500	I.M.S	Yellow	5
WGW541PML	500	Ethanol	Orange	5



Bottles, wash, non-venting, wide neck, DIY, LDPE



Azlon

- Do-it-yourself wash bottles with blank write-on-panel
- Indelibly printed in 3 languages (English, French and German)
- Supplied with adhesive hazard labels

Product Code	Description	Pack qty.
WGW001PML	250ml Custom/DIY with white cap	5
WGW002PML	500ml Custom/DIY with white cap	5
WGW020PML	1000ml Custom/DIY with white cap	5
WGWPEN01	Indelible black marker pen for custom/DIY wash bottles	2



Bottles, wash, Gram stain, venting, LDPE



Azlon

- Pre-labelled with Gram stain solutions, hazard warning labels and instructions for use
- With patented DripLok® vapour venting technology
- The set of five wash bottles are printed with:-
 - Crystal violet solution
 - Lugol's iodine solution
 - Gram iodine solution
 - Gram colour/de-colourising solution
 - Safranine solution

Product Code	Description	Pack qty.
WGW0255V	Set of five 250ml Gram Stain venting wash bottles	5





Bottles, wash, tracker, LDPE



Azlon

- Wash bottle designed with complete labelling facility to ensure full traceability
- Meets industry standards including those required by the Clinical Pathology Accreditation body
- Ideal for use in the clinical & general hospital market
- Unique write-on, wipe-off panel
- DripLok® vapour venting cap version available - for ultimate safety with volatile solvents
- Supplied with a set of COSHH labels

Product Code	Capacity (ml)	Cap Type	Closure colour	Pack qty.
WTR250P	250	Non-venting	Green	5
WTR250VT	250	Vapour-Venting	Red	5
WTR500P	500	Non-venting	Green	5
WTR500VT	500	Vapour-Venting	Red	5



Recordable information includes: bottle contents, first use and expiry dates, lot number, COSHH information, originator and date of receipt/preparation.

Bottles, wash, wide neck, LDPE



Azlon

- Square shoulder wash bottles featuring a wide neck for easy spill-free filling
- Fitted with colour-coded one-piece PP closures that maintain their shape in use
- Closures feature precision jet-tip aperture for fine control



Product Code	Capacity (ml)	Closure colour	Pack qty.
WGW230P	250	White	5
WGW231P	250	Red	5
WGW232P	250	Yellow	5
WGW233P	250	Green	5
WGW234P	250	Blue	5
WGW236P	500	White	5
WGW237P	500	Red	5
WGW238P	500	Yellow	5
WGW239P	500	Green	5
WGW235P	500	Blue	5
WGW443P	1000	White	5
WGW445P	1000	Red	5
WGW444P	1000	Yellow	5
WGW447P	1000	Green	5
WGW446P	1000	Blue	5
WGW229P	250	Mixed pack one of each colour	1



Bottles, wash, classic style, narrow neck, LDPE



Azlon

- Traditional and popular square shoulder round wash bottles
- Closures feature precision jet-tip aperture for fine control

Product Code	Capacity (ml)	Closure colour	Pack qty.
WGF230P	250	White	5
WGF236P	500	White	5



Bottles, wash, slope shoulder, printed, LDPE



Azlon

- Labelled wash bottles for easy identification of contents
- Indelibly printed with a choice of seven popular laboratory solvents, appropriate hazard symbols and CAS numbers
- The slim design enables comfortable handling and enhanced ease of use
- Fitted with colour-coded polypropylene closures
- Closures feature precision jet-tip aperture for fine control

Product Code	Capacity (ml)	Printed	Print / closure colour	Pack qty.
WGF530P	250	Water	White	5
WGF600P	250	Distilled water	White	5
WGF531P	250	Acetone	Red	5
WGF532P	250	Methanol	Green	5
WGF533P	250	Isopropanol	Blue	5
WGF534P	250	I.M.S.	Yellow	5
WGF535P	250	Ethanol	Orange	5
WGF536P	500	Water	White	5
WGF601P	500	Distilled water	White	5
WGF537P	500	Acetone	Red	5
WGF538P	500	Methanol	Green	5
WGF539P	500	Isopropanol	Blue	5
WGF540P	500	I.M.S.	Yellow	5
WGF541P	500	Ethanol	Orange	5





Bottles, wash, slope shoulder, narrow neck, LDPE



- The slim design enables comfortable handling and enhanced ease of use
- Fitted with a choice of white or red polypropylene swivel dispensing closures
- Choice of three sizes
- Closures feature precision jet-tip aperture for fine control

Product Code	Capacity (ml)	Closure colour	Pack qty.
WGF330P	250	White	5
WGF331P	250	Red	5
WGF336P	500	White	5
WGF337P	500	Red	5
WGF240P	1000	White	5
WGF241P	1000	Red	5



Bottles, wash, coloured, narrow neck, LDPE



- Coloured wash bottles with matching closures
- Ideal for colour-coding purposes
- Fitted with polypropylene closures
- Choice of four colours

Product Code	Capacity (ml)	Bottle colour	Pack qty.
WGR036P	500	Green	5
WGR038P	500	Red	5
WGR136P	500	Yellow	5
WGR138P	500	Blue	5



Bottles, wash, integral, narrow neck, LDPE



- Ergonomic wash bottles with an integrally moulded dispensing tube jet tip
- Slim hexagonal cross section makes the bottles particularly suited to smaller hands
- Precision tip is ideal for fine liquid jet dispensing

Product Code	Capacity (ml)	Bottle colour	Pack qty.
BGF130P	250	Natural	5
BGF136P	500	Natural	5



Bottle carriers, cluster design, polypropylene



Azlon

- A simple and safe carrying system for use in the laboratory
- Strong lightweight construction
- Will accept most 500ml bottles
- Internal cavity diameter 90mm

Product Code	Description	Pack qty.
BGS024	6 compartment bottle carrier	1



Bottle carriers, coated steel



Azlon

- Manufactured from polyamide coated steel
- Offers a better heat and chemical resistance than other coatings
- Ideal for safely carrying up to six bottles or wash bottles

Product Code	Max. bottle diam. mm	Pack qty.
BGS040	60	1
BGS042	74	1



Boxes, airtight, polyethylene



Azlon

- Tough lightweight and unbreakable in normal use
- Tight fitting snap on lids create an airtight seal
- Suitable for general and refrigerated storage down to -50°C

Product Code	Capacity (ml)	External dim. (l x w x h) mm	Pack qty.
BWY030	500	100 x 100 x 65	1
BWY032	1000	100 x 100 x 125	1
BWY034	1000	210 x 100 x 65	1
BWY036	1500	210 x 100 x 90	1
BWY038	2000	210 x 210 x 65	1
BWY039	3500	210 x 210 x 90	1





Reaction vessel bubbler



- Ideal for closing reaction mixture from the atmosphere
- Side arm to facilitate filling with mineral oil
- Bubblers have capacity of approx 5ml

Product Code	Cone size	Pack qty.
GB1/19	19/26	1
GB1/24	24/29	1
GB1/29	29/32	1

 Capacity measurement to graduated fill line.



Reaction Vessel bubbler, with gas inlet



- Ideal for closing reaction mixture from the atmosphere
- With gas inlet to provide continuous flow of inert gas (N₂ or Ar) over the reaction
- Complete with detachable plastic hose connection to allow easy and safe attachment to 9mm flexible tubing
- Bubblers have capacity of approx 5ml

Product Code	Cone size	Pack qty.
GB2/19SC	19/26	1
GB2/24SC	24/29	1
GB2/29SC	29/32	1

 Capacity measurement to graduated fill line.



Mini gas bubbler



- For use in inert atmosphere experiments
- Ideal for bubble counting
- Complete with detachable plastic hose connections to allow easy and safe attachment to 9mm bore flexible tubing

Product Code	Capacity (ml)	Pack qty.
GB3/SC	2	1



Buckets, spouted, HDPE



Azlon

- Durable spouted buckets for easy pouring
- Handle grip for easy lifting and carrying
- Choice of white or black
- Moulded graduations

Product Code	Capacity litres	Sub div. litres	Diam. x height mm	Colour	Pack qty.
BWX104	10.5	0.5	286 x 283	Black	1
BWX106	17	0.5	330 x 315	Black	1
BWX112	10.5	0.5	286 x 283	White	1
BWX114	17	0.5	330 x 315	White	1



Buckets, square, HDPE



Azlon

- Durable square shape allows economical use of space
- Handle grip for easy lifting and carrying
- Choice of white or black
- Moulded graduations (14 litre x 0.5 divisions)

Product Code	Capacity litres	Sub div. litres	External dim. (l x w x h) mm	Colour	Pack qty.
BWX108	14	0.5	292 x 292 x 292	Black	1
BWX116	14	0.5	292 x 292 x 292	White	1



Buckets lids square, HDPE

- Lids with moulded inset handle for buckets above

Product Code	Description	External dim. (l x w x h) mm	Colour	Pack qty.
BWX110	Lid for bucket	280 x 280 x 45	Black	1
BWX118	Lid for bucket	280 x 280 x 45	White	1

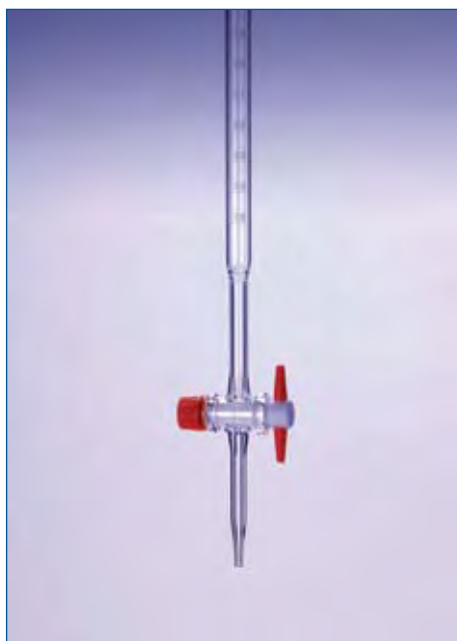

Burettes, PTFE key, class AS, works certified

PYREX®

- Complies with ISO 385
- Individually tested and supplied with certificate showing exact volume dispensed at 3 points on the scale
- Individual serial number and certificate provides complete traceability to National Standards
- Each burette has a +30s waiting time before final reading can be taken
- Manufactured from precision-bore borosilicate glass tubing for high accuracy
- 1.5mm bore PTFE key which requires no lubrication
- White enamel graduations

Product Code	Capacity (ml)	Grads. ml	Tol. ± ml	Pack qty.
3295/22ASWC	10	0.02	0.02	1
3295/24ASWC	25	0.10	0.05	1
3295/26ASWC	50	0.10	0.05	1
3295/28ASWC	100	0.20	0.10	1

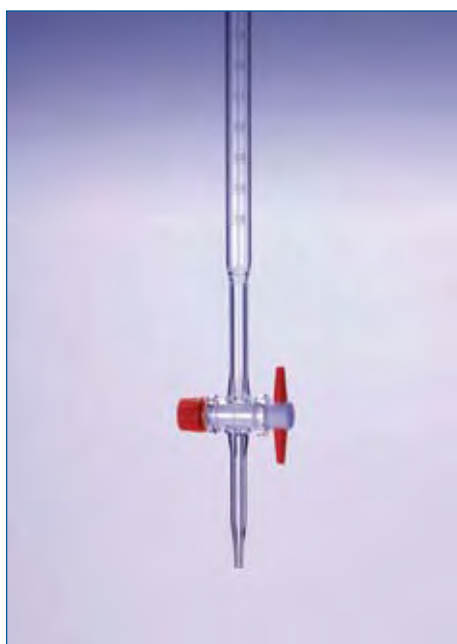

Burettes, PTFE key, class AS

PYREX®

- Complies with ISO 385
- Manufactured from precision-bore tubing (borosilicate glass) for high accuracy
- Each burette has a +30s waiting time before final reading can be taken
- Graduations in white enamel for increased visibility with dark solutions
- Grease-free interchangeable PTFE key with 1.5mm bore

Product Code	Capacity (ml)	Grads. ml	Tol. ± ml	Pack qty.
3295/12AS	10	0.02	0.02	1
3295/14AS	25	0.10	0.05	1
3295/16AS	50	0.10	0.05	1
3295/18AS	100	0.20	0.10	1



Burettes, PTFE key, class AS, Schellbach

PYREX®

- Complies with ISO 385
- Graduations and inscriptions in blue enamel
- Schellbach burette tube with vertical white stripe and central blue ribbon
 - Facilitates accurate reading of meniscus
 - exact position of the meniscus is clearly defined where the blue ribbon splits into a wide and narrow band
- With funnel top to make filling easier and safer
- Each burette has a +30s waiting time before final reading can be taken
- Manufactured from chemically resistance borosilicate glass
- Grease-free interchangeable PTFE key with 1.5mm bore

Product Code	Capacity (ml)	Grads. ml	Tol. ± ml	Pack qty.
492092	10	0.05	0.03	1
492093	25	0.1	0.05	1
492094	25	0.05	0.03	1
492095	50	0.1	0.05	1

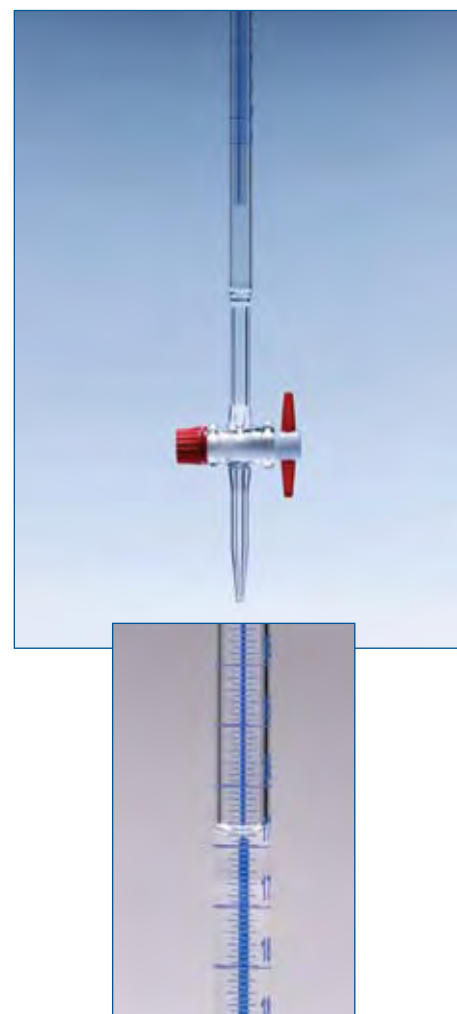

Burettes, PTFE key, class B

PYREX®

- Complies with ISO 385
- Fitted with interchangeable PTFE keys for grease-free performance, with 1.5mm bore
- White enamel graduations for good visibility with dark coloured solutions
- Manufactured from borosilicate glass for increased chemical resistance

Product Code	Capacity (ml)	Grads. ml	Tol. ± ml	Pack qty.
3295/02	10	0.02	0.05	1
3295/04	25	0.10	0.10	1
3295/06	50	0.10	0.10	1
3295/08	100	0.20	0.20	1



Schools and colleges may wish to consider Azlon® tough acrylic burettes as detailed on page. 85.

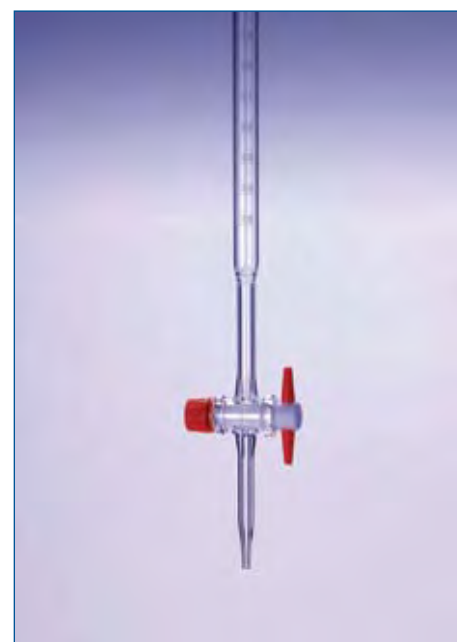



Burettes, PTFE key, blue graduations, class B

MBL®

- Complies with ISO 385
- 10, 25 and 50 ml sizes are available fitted with funnel top to make filling easier and safer
- Grease-free PTFE stopcock with 1.5mm bore
- Graduations in easy to read blue enamel
- Manufactured from borosilicate glass

Product Code	Capacity (ml)	Grads. ml	Tol. ± ml	Pack qty.
BRB070P	10	0.02	0.05	1
BRB074P	25	0.10	0.10	1
BRB075P	25	0.10	0.10	1
BRB076P	50	0.10	0.10	1
BRB077P	50	0.10	0.10	1

i BRB070P, BRB075P, BRB077P are fitted with fluted funnel tops.



Burettes, Rotaflo, PTFE key, class B

MBL®

- Complies with ISO 385
- With GP Rotaflo® stopcock having PTFE key
 - No lubrication required
 - No seizure with caustic solutions
 - Provides fine drop control
 - 3.0mm key bore
- Graduations in permanent amber stain which is fused into the glass and is especially resistant to aggressive cleaning solutions
- Manufactured from borosilicate glass

Product Code	Capacity (ml)	Grads. ml	Tol. ± ml	Pack qty.
BRB402	10	0.10	0.05	1
BRB404	25	0.10	0.10	1
BRB406	50	0.10	0.10	1
BRB408	100	0.20	0.20	1

i BRB402 is supplementary to ISO 385.



Burettes, modular, PTFE stopcock, class B

MBL[®]

- Complies with ISO 385
- With funnel top to make filling easier and safer
- PTFE stopcock for grease-free performance
- Easy to read blue enamel graduations
- Burette manufactured from borosilicate glass
- Modular design with detachable burette tube, stopcock and jet for easy replacement

Product Code	Capacity (ml)	Grads. ml	Tol. ± ml	Pack qty.
BRB264P	25	0.10	0.10	1
BRB266P	50	0.10	0.10	1

i BRB284 - Replacement glass jets are made from soda-lime glass.

Replacement parts for modular burette

Product Code	Description	Pack qty.
BRB274P	25ml glass burette tube	1
BRB276P	50ml glass burette tube	1
BRB284	Glass jet for 25 & 50ml burettes	5
BRB290	PTFE stopcock	10



Burettes, glass key, class AS, Schellbach

PYREX[®]

- Complies with ISO 385
- Graduations and inscriptions in blue enamel
- Schellbach burette tube with vertical white stripe and central blue ribbon
 - Facilitates accurate reading of meniscus
 - exact position of the meniscus is clearly defined where the blue ribbon splits into a wide and narrow band
- With funnel top to make filling easier and safer
- Each burette has a +30s waiting time before final reading can be taken
- Manufactured from chemically resistance borosilicate glass
- With interchangeable 1.5mm bore glass key

Product Code	Capacity (ml)	Grads. ml	Tol. +/- ml	Pack qty.
492145	10	0.05	0.03	1
492146	25	0.1	0.05	1
492147	25	0.05	0.03	1
492148	50	0.1	0.05	1





Burettes



Burettes, glass key, class B

MBL®

- Complies with ISO 385
- 1.5mm Key bore
- Replacement keys are available in the event of loss or damage: keys are fully interchangeable.
- Graduations in easy to read blue enamel
- Manufactured from borosilicate glass

Product Code	Capacity (ml)	Grads. ml	Tol. ± ml	Pack qty.
BRB050P	10	0.02	0.05	1
BRB056P	25	0.10	0.10	1
BRB058P	50	0.10	0.10	1
BRB060P	100	0.20	0.20	1



*BRB050P has a funnel top to aid filling.
SSD102K Spare keys are available on page 243.*



Burettes, Sofnol, auto zero, Rotaflo stopcock, class B

PYREX®

- Complies with ISO 385
- Easy filling and automatic zero
 - Squeeze the polyethylene bottle to fill the burette
 - Release pressure to allow excess liquid to drain back into bottle and set the burette to zero
- With PTFE Rotaflo® Stopcock for grease-free performance and fine drop-wise control
- 3mm bore PTFE key
- Graduations in white enamel
- Manufactured from borosilicate glass
- Burettes and bottles should be ordered separately

Product Code	Capacity (ml)	Grads. ml	Tol. ± ml	Pack qty.
3298/02	10	0.1	0.10	5
3298/03	20	0.1	0.10	5
3298/04	25	0.1	0.10	5

Polyethylene reservoir bottles

Product Code	Description	Pack qty.
3299/04	500ml Polyethylene reservoir bottle	1
3299/06	1000ml Polyethylene reservoir bottle	1



Burettes, Sofnol, auto zero, pinch clip, class B

MBL®

- Complies with ISO 385
- Easy filling and automatic zero
 - Squeeze the polyethylene bottle to fill burette
 - Release pressure to allow excess liquid to drain back into bottle and set the burette to zero
- Easy to read blue enamel graduations
- Manufactured from borosilicate glass
- With simple rubber tube and pinch valve for low cost replacement

Product Code	Capacity (ml)	Grads. ml	Tol. ± ml	Reservoir bottle capacity ml	Pack qty.
BRB004	10	0.1	0.10	500	1
BRB006	20	0.1	0.10	1000	1

Replacement parts

Product Code	Description	Pack qty.
3299/04	500ml Polyethylene reservoir bottle	1
3299/06	1000ml Polyethylene reservoir bottle	1
BRB042	Rubber pinch clip and glass jet	5
BRB256	Glass jet only	5



Burettes, automatic, PTFE key, class AS

PYREX®

- With automatic zero facility
- Simple operation
 - To fill burette apply a slight positive pressure to lower side-arm
 - To set zero, release pressure to allow excess liquid to siphon back into the bottle
- Burettes manufactured from chemically resistant Pyrex® borosilicate glass
- White enamel graduations
- Burettes and accessories should be ordered separately

Product Code	Capacity (ml)	Grads. ml	Tol. ± ml	Pack qty.
3296/02AS	10	0.02	0.02	1
3296/04AS	25	0.05	0.03	1
3296/06AS	50	0.10	0.05	1

 All Automatic burettes feature a 29/32 cone.





Burettes, automatic, PTFE key, class AS, Schellbach **PYREX®**

- With automatic zero facility
- Burettes manufactured from chemically resistant Pyrex® borosilicate glass and feature a 29/32 Quickfit® cone
- Blue enamel graduations with Schellbach stripe
- Schellbach burette tube with vertical white stripe and central blue ribbon
 - facilitates accurate reading of the meniscus
 - exact position of the meniscus is clearly defined where the blue ribbon splits into a wide and narrow band
- PTFE stopcock

Product Code	Capacity (ml)	Grads. ml	Tol. ± ml	Pack qty.
3396/02AS	10	0.02	0.02	1
3396/04AS	25	0.05	0.03	1
3396/06AS	50	0.10	0.05	1

i Burettes and accessories should be ordered separately.



Burettes, automatic, PTFE key, class AS, Schellbach with intermediate stopcock **PYREX®**

- As 3396 range with intermediate stopcock
- Intermediate stopcock facilitates easy drainage of liquid back into reservoir

Product Code	Capacity (ml)	Grads. ml	Tol. ± ml	Pack qty.
3496/02AS	10	0.02	0.02	1
3496/04AS	25	0.05	0.03	1
3496/06AS	50	0.10	0.05	1

i All automatic burettes feature a 29/32 Quickfit® cone.



Automatic burette accessories

Product Code	Description	Pack qty.
3297/12	2000ml glass reservoir with 29/32 joint	1
3297/14AS	Rubber blowing ball to fit Class AS Auto burettes	1

i 2L reservoir is manufactured from soda-lime glass.

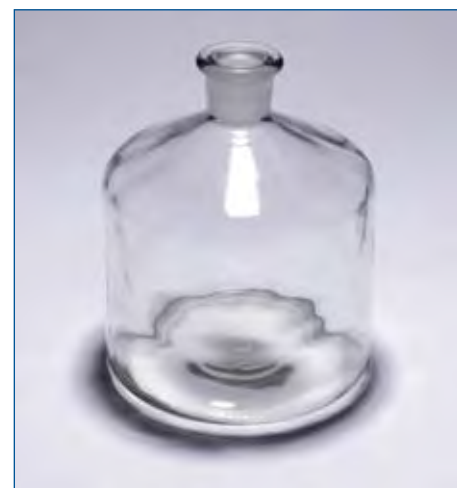

Burettes, acrylic, with PMP/PE stopcocks, class B



Azlon

- Acrylic construction for strength and transparency
- Graduations are screen printed in black to ISO 385 Class B accuracy
- Suitable for use in educational laboratories especially where breakages often occur
- Unaffected by most dilute aqueous solutions but unsuitable for use with organic solvents
- Turning the stopcock through 90° makes it suitable for left or right handed use
- Stopcocks can be removed for easy cleaning

Product Code	Capacity (ml)	Grads. ml	Tol. +/- ml	Pack qty.
BDH112T	25	0.1	0.1	1
BDH118T	50	0.1	0.1	1
BDH124T	100	0.2	0.2	1

Burettes, acrylic, spares

Product Code	Description	Pack qty.
SWQ030TAR	Spare stopcock for BDH118T & 124T	1
SWQ028T	Spare stopcock for BDH112T	1



i See chemical resistance chart in the technical section for more details.

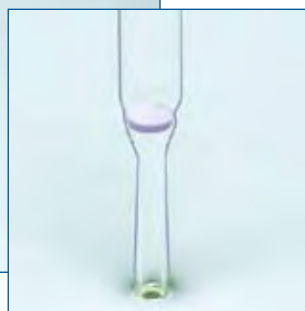

Chromatography column, plain

PYREX®

- Simple and economical column - ideal for educational use
- With chemically resistant glass sintered disc
- Manufactured from Pyrex® borosilicate glass

Product Code	Nom. capacity ml	Body O.D. mm	Length excluding stem mm	Stem O.D. mm	Pack qty.
3775/02M	30	14	355	8	5



Chromatography columns with Rotaflo stopcock



- With PTFE Rotaflo® Stopcock for fine control of eluent flow
- Chemically resistant glass sintered disc - porosity 0
- Ground glass socket accepts Quickfit® reservoirs
- Manufactured from Pyrex® borosilicate glass

Product Code	I.D. mm	Effective length mm	Socket size	Pack qty.
CR10/10	10	100	14/23	1
CR10/20	10	200	14/23	1
CR10/30	10	300	14/23	1
CR10/40	10	400	14/23	1
CR20/20	20	200	19/26	1
CR20/30	20	300	19/26	1
CR20/40	20	400	19/26	1
CR20/50	20	500	19/26	1
CR30/40	26	400	24/29	1
CR30/50	26	500	24/29	1
CR40/40	30	400	29/32	1
CR40/50	30	500	29/32	1
CR50/40	30	400	34/35	1
CR50/50	30	500	34/35	1
CR60/40	40	400	40/38	1
CR60/50	40	500	40/38	1



Reservoirs for use with chromatography columns are detailed on page 177.



Chromatography column, Rotaflo stopcock and ground cone



- With glass sintered disc (porosity 0) to support column packing
- GP Rotaflo® stopcock with PTFE key for fine control of eluent flow
- Stem within lower cone allows mounting on a Büchner flask for vacuum flash chromatography
- Manufactured from borosilicate glass

Product Code	Nom. bore mm	Effective length mm	Approx overall length	Socket size	Cone size	Pack qty.
CR12/10	10	100	270	14/23	19/26	1
CR12/30	10	300	470	14/23	19/26	1



Chromatography columns, with ground cone



- With glass sintered disc (porosity 0) to support column packing
- Upper socket can be connected to a solvent reservoir
- Lower cone can be connected to stopcock adapter CR3T/23 to control eluent flow
- Manufactured from Pyrex® borosilicate glass

Product Code	Nom. bore mm	Effective length mm	Approx overall length	Socket size	Cone size	Pack qty.
CR32/20	18	200	310	24/29	19/26	1
CR32/30	18	300	415	24/29	19/26	1
CR32/40	18	400	515	24/29	19/26	1





Chromatography, stopcock adapter



- With GP Rotafluo® stopcock having PTFE key for fine control of eluent flow
 - No lubrication required
 - No contaminating greases
 - No chemical corrosion
- Ideal for use with Quickfit® CR32: columns

Product Code	Socket size	Cone size	Approx overall height (mm)	Stopcock bore mm	Pack qty.
CR3T/23	19/26	24/29	190	6.0	1



Clamps, burette, polypropylene & rubber



Azlon

- Spring loaded polypropylene clamps that are corrosion resistant
- Allow clear view of graduations along the full length of the burette
- Rubber grips prevent slipping
- An interchangeable compression cone on the central boss provides a firm grip on rods 11 - 14mm in diameter

Product Code	Model	Pack qty.
CWH002	Single clamp	1
CWH004	Double clamp	1



Clamps, tubing



- For use with flexible rubber and plastic tubing
- Provides fine flow control of liquids and gases
- Easy one-handed adjustment: just roll serrated wheel along sloped floor
- Manufactured from thermoplastic polyester

Product Code	For tubing size	Pack qty.
KT4.5	O.D. up to 4.5mm	5
KT6	O.D. up to 6mm	5
KT10	O.D. up to 10 mm	5
KT14	O.D. up to 14mm	5



Concentrate, Lipsol® Detergent

Lipsol®

- Excellent cleaning performance, ideal for use with laboratory glassware, plasticware, rubber, ceramics and stainless steel
- Economical price
- Non-corrosive, non-irritant and totally biodegradable surface-active cleaning agent
- Free of chlorine bleaches, phosphates and enzymes

Product Code	Description	Pack qty.
40023	Lipsol® concentrate 2 x 5 Litre Jerry Cans	1



Not suitable for use on non-ferrous metals, especially aluminium, zinc or on polycarbonates. Product information, MSDS's and batch certificates downloadable from www.scilabware.com/downloads.



Cold trap



- Designed for use in vacuum systems
- Prevents vapours from volatile materials from damaging pumps etc.
- Easy to use:
 - immerse trap into Dewar vessel containing refrigerant e.g. dry ice
 - volatile materials passing through system are frozen onto the cold surface

Product Code	Description	Socket size	Cone size	Pack qty.
MF28/52	Trap head	19/26	34/35 & 19/26	1
MF24/5	Trap body, 250mm overall length	34/35	-	5



Trap head can be connected to flexible vacuum hose using adapters MF10/2B/SC and MF13/2/SC.





Condenser, Air



- Simple condensers for condensation of materials with boiling points above 150°C

Product Code	Approx surface area x 10 ⁻² m ²	Socket size	Cone size	Approx effective length mm	Approx overall length mm	Pack qty.
C2/11	1.0	14/23	14/23	200	260	1
C2/12	1.0	19/26	19/26	150	210	1
FC7/23	2.0	24/29	24/29	250	365	1
C2/22	2.5	19/26	19/26	400	470	1
FC7/43	4.0	24/29	24/29	500	615	1



Condenser, Allihn, with ground cone



- Ideal for reflux applications
- Inner bulb sections provide increased cooling surface
- With detachable plastic screwthread connectors for easy and safe attachment of flexible tubing

Product Code	Approx surface area x 10 ⁻² m ²	Cone size	Approx effective length mm	Approx overall length mm	Pack qty.
CX7/02/SC	1.3	19/26	250	400	1
CX7/03/SC	1.3	24/29	250	405	1
CX7/04/SC	1.3	29/32	250	415	1
CX7/05/SC	1.3	34/35	250	335	1
CX7/06/SC	1.3	40/38	250	365	1
CX7/08/SC	1.5	50/42	250	365	1



Condenser, Allihn, with ground cone and socket



- As above but with ground socket

Product Code	Approx surface area x 10 ⁻² m ²	Socket size	Cone size	Approx effective length mm	Approx overall length mm	Pack qty.
CX7/33/SC	1.8	24/29	24/29	400	545	1
CX7/44/SC	1.8	29/32	29/32	400	550	1

 For spare screwthread connectors please refer to page 96.



Condenser, coil, with ground cone



- Coolant is circulated through a coil having a very large cooling surface
- Ideal for use in the upright reflux mode where counter-current cooling is possible
- Supplied with detachable plastic connectors for the attachment of rubber hose

Product Code	Approx surface area x 10 ⁻² m ²	Cone size	Approx effective length mm	Approx overall length mm	Pack qty.
CX3/05/SC	2.0	34/35	160	320	1
CX3/06/SC	3.5	40/38	207	380	1
CX3/08/SC	2.0	50/42	155	348	1

i For spare screwthread connectors, please refer to page 96.



Condenser, coil, with ground cone and socket



- Suitable for either reflux or distillation work
- Highly efficient condensers with a large cooling surface
- Supplied with detachable plastic screwthread connectors which allow 9mm flexible tubing to be fitted easily and safely

Product Code	Approx surface area x 10 ⁻² m ²	Socket size	Cone size	Approx effective length mm	Approx overall length mm	Pack qty.
C3/12/SC	2.0	19/26	19/26	165	305	1
C3/13/SC	2.0	24/29	24/29	165	310	1
C3/14/SC	2.0	29/32	29/32	165	315	1
C3/22/SC	4.0	19/26	19/26	320	460	1
C3/23/SC	4.0	24/29	24/29	320	465	1
C3/24/SC	4.0	29/32	29/32	320	470	1



Condenser, coil, reversible



- Highly versatile reflux condensers
- Each end of the condenser is fitted with a different size cone thus reducing the need for adapters
- With detachable plastic connectors for the attachment of flexible tubing

Product Code	Approx surface area x 10 ⁻² m ²	Cone size	Approx effective length mm	Approx overall length mm	Pack qty.
CX3/23/SC	2.0	19/26 & 24/29	160	315	1
CX3/35/SC	2.0	24/29 & 34/35	160	335	1





Condenser, twin-coil



- With two independent cooling coils
- Each can be fed from separate water supplies for maximum efficiency

Product Code	Approx surface area x 10 ⁻² m ²	Socket size	Cone size	Approx effective length mm	Approx overall length mm	Pack qty.
C4/13/SC	5.5	24/29	24/29	207	390	1

i For spare screwthread connectors, please refer to page 96.



Condenser, multi-coil, large scale



- Features a double coil design with a common water inlet
- Suitable for pilot plant work

Product Code	Approx surface area x 10 ⁻² m ²	Socket size	Cone size	Approx effective length mm	Approx overall length mm	Pack qty.
C13/55	9.0	34/35	34/35	230	440	1
C13/55/2	18.0	34/35	34/35	420	660	1

i Due to their larger size, these condensers have glass olives for the attachment of flexible tubing.



Condenser, jacketed coil



- Complies with DIN 12593
- Coil condenser has an outer water jacket
- Coil provides large cooling surface
- Jacket avoids vapour creeping around the coil
- Ideal for reflux work

Product Code	Approx surface area x 10 ⁻² m ²	Socket size	Cone size	Approx effective length mm	Approx overall length mm	Pack qty.
CX6/22/SC	4.0	19/26	19/26	160	360	1
CX6/33/SC	4.0	24/29	24/29	160	365	1
CX6/44/SC	4.0	29/32	29/32	160	370	1
CX6/05/SC	4.0	-	34/35	160	380	1

i CX6/05/SC has one 34/35 cone and a plain glass chimney at the top.



Condenser, cold finger



- For immersion into distillation assemblies etc.
- Can be used to regulate refluxing by adjusting the flow of air or water through it

Product Code	Approx surface area x 10 ⁻² m ²	Cone size	Approx effective length mm	Approx overall length mm	Pack qty.
FC14/00/SC	0.35	19/26	100	185	1



Condenser, double surface, Davies



- Highly efficient condenser with large cooling surface
- Inner cooling surface gives 'baffle' effect
- Outer cooling surface prevents 'creep' with low boiling point liquids
- With detachable plastic screwthread connectors for easy and safe attachment of flexible tubing

Product Code	Approx surface area x 10 ⁻² m ²	Socket size	Cone size	Approx effective length mm	Approx overall length mm	Pack qty.
C5/11/SC	1.7	14/23	14/23	160	275	1
C5/12/SC	1.7	19/26	19/26	160	295	1
C5/13/SC	2.3	24/29	24/29	160	300	1
C5/22/SC	2.3	19/26	19/26	200	340	1
C5/23/SC	3.0	24/29	24/29	200	345	1
C5/24/SC	3.0	29/32	29/32	205	365	1
CX5/23/SC	3.0	-	24/29	205	350	1
CX5/25/SC	3.0	-	34/35	205	360	1



i CX5/23/SC and CX5/25/SC are fitted with a plain glass chimney instead of a socket.



Condenser, ether



- Highly efficient coil condenser suitable for condensing very volatile liquids
- Inner coil with large surface area
- Outer water jacket to avoid vapour creep around the coil
- Coil and jacket are independent and can be fed from separate water supplies for maximum efficiency
- With detachable plastic screwthread connectors for the easy and safe attachment of flexible tubing

Product Code	Approx surface area $\times 10^{-2}m^2$	Socket size	Cone size	Approx effective length mm	Approx overall length mm	Approx length of side tube mm	Pack qty.
C11/23/SC	6.5	19/26	24/29	165	315	205	1

 For spare screwthread connectors, please refer to page 96.

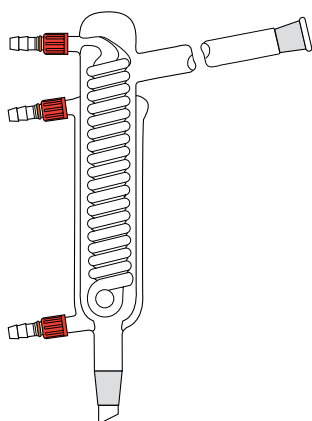

Condenser, Inland Revenue



- Inland Revenue Pattern
- Highly efficient
- Vapour and distillate move down through the coil
- Coolant water flows outside the coil
- Complete with detachable plastic hose connectors for easy, safe attachment of flexible tubing

Product Code	Approx surface area $\times 10^{-2}m^2$	Socket size	Cone size	Approx effective length mm	Approx overall length mm	Pack qty.
C6/12/SC	2.5	19/26	19/26	205	340	1
C6/13/SC	2.5	24/29	24/29	205	340	1



Inland Revenue condensers should be used in the vertical mode only with vapour fed in via the upper socket and liquid distillate leaving via the lower cone. Distillation rates should be slow to avoid 'slugging' and back pressure in the coil.



Condenser, Liebig, with ground cone and socket



- Complies with DIN 12576
- Popular water-jacketed condenser suitable for distillation and reflux applications
- With detachable plastic screwthread connectors for easy and safe attachment of rubber hose

Product Code	Approx surface area x 10 ⁻² m ²	Socket size	Cone size	Approx effective length mm	Approx overall length mm	Pack qty.
C1/00	0.15	10/19	10/19	60	135	1
C1/11/SC	0.06	14/23	14/23	155	260	1
C1/12/SC	1.00	19/26	19/26	208	340	1
C1/12/25/SC	1.30	19/26	19/26	250	380	1
C1/13/SC	1.00	24/29	24/29	250	390	1
C1/14/25/SC	1.30	29/32	29/32	250	400	1
C1/22/SC	2.00	19/26	19/26	398	530	1
C1/23/SC	2.00	24/29	24/29	395	535	1
C1/44/SC	2.90	29/32	29/32	400	550	1



i C1/00 is fitted with glass olives because of size limitations.

One piece distillation apparatus



- Comprises Liebig condenser, stillhead and receiver adapter in a single piece
- Angle and position pre-defined
- Simple to set up with fewer clamps required
- Less grease contamination
- No air leakage under vacuum
- No liquid hold-up at the joints

Product Code	Cone size	Socket size	Approx effective condenser length mm	Pack qty.
DA1/22	19/26	14/23	155	1





Connectors, screwthread



- For use with glassware manufactured by SciLabware Ltd having 13mm screwthread inlets and outlets
- Allows 9mm bore rubber hose and flexible tubing to be attached to the glassware easily and safely
- Polypropylene screwthread connectors with Viton 'O' rings for use up to 140°C
- PTFE screwthread connectors with PTFE protected 'O' rings for use up to 200°C
- PTFE connectors have a high chemical resistance and are ideal for connections in contact with aggressive liquids or chemical vapours

Product Code	Description	Pack qty.
4510/02	Polypropylene screwthread connector	10
4510/04	PTFE screwthread connector	10
4511/02	Spare Viton 'O' ring	10



Connectors, screwthread holder



- For use with all connectors manufactured by SciLabware Ltd and having 13mm screwthread inlets and outlets
- Screws onto the screwthread connector to hold it whilst inserting into the tubing
- Allows safer and easier removal of the connector from the hose or tubing
- Autoclavable

Product Code	Description	Pack qty.
4512/02	Screwthread holder	5



Connectors, 'T' pattern, white polypropylene



- "T" pattern tubing connectors in white polypropylene
- Tapered arms are rigid with steps to give firm grip
- Autoclavable at 121°C with good chemical resistance

Product Code	O.D. (mm)	I.D. mm	Pack qty.
CWH204	4 - 7	2	10
CWH206	6 - 7	4	10
CWH208	8 - 9	7	10
CWH210	10 - 12	9	10



Connectors, 'Y' pattern, white polypropylene



- "Y" pattern tubing connectors in white polypropylene
- Tapered arms are rigid with steps to give firm grip
- Autoclavable at 121°C with good chemical resistance

Product Code	O.D. (mm)	Pack qty.
CWH304	4 - 7	10
CWH306	6 - 7	10
CWH308	8 - 9	10
CWH310	10 - 12	10



Connectors, straight pattern, polypropylene



- Straight pattern tubing connectors in white polypropylene
- For connecting tubing of similar or different sizes
- Tapered arms are rigid with steps to give firm grip
- Autoclavable at 121°C with good chemical resistance

Product Code	To fit tube I.D. mm	Pack qty.
CWH600	4 - 7 and 4 - 7	10
CWH602	4 - 7 and 7 - 12	10
CWH604	7 - 12 and 7 - 12	10
CWH606	4 - 7 and 10 - 15	10
CWH608	7 - 12 and 10 - 15	10
CWH610	10 - 15 and 10 - 15	10



Connectors, non-return valves, polypropylene and neoprene



- Designed for use in vacuum lines and fluid handling systems
- Neoprene disc valve has no spring and will operate at very low back pressures (NWH905P valve is now manufactured from Nitrile-Rubber)
- Useful for preventing back pressure in filter flasks
- Printed arrow indicates the direction of flow
- Rigid with stepped tapered arms to give firm grip on tubing
- Easily disassembled for cleaning

Product Code	O.D. (mm)	Pack qty.
NWH902P	4 - 7	5
NWH905P	8 - 10	5
NWH906P	11 - 15	5





Gallipots, polypropylene



- Low form dishes made from medical grade polypropylene
- Suitable for sampling, short term storage, micro-analysis or many other applications
- Moulded graduations to capacity
- 60ml pots are available sterile in individually wrapped vac packs
- Non-sterile versions are autoclavable to 121°C

Product Code	Volume ml	Description	Packaging	Pack qty.
GWY520	60	Non-sterile	Bulk	1000
GWY524	60	Sterile	Individually wrapped	400
GWY526	120	Non-sterile	Bulk	1000
GWY528	250	Non-sterile	Bulk	750



Gallipot, tray, 3 compartment, polypropylene



- 3 compartment tray with 2 integral gallipots
- Made from medical grade polypropylene
- Suitable for sampling, short term storage, micro-analysis or any other applications
- Non-sterile - can be autoclavable at 121°C

Product Code	Dimensions (h x l x w) mm	Pack qty.
GWY530	28 x 196 x 130	200



Containers, screw cap, polypropylene



- Useful autoclavable wide neck containers with liner-less screw caps
- Good chemical resistance
- Ideal for storage of samples, powders, animal feeds etc.

Product Code	Capacity (ml)	O.D. x height mm	Pack qty.
JWP0030P	30	43 x 43	72
JWP0060P	60	53 x 47	48
JWP0125P	125	70 x 60	36
JWP0250P	250	89 x 66	36
JWP0500P	500	89 x 97	24
JWP0950P	950	120 x 100	24
JWP1200P	1200	120 x 132	24



Containers, snap-on lid, polypropylene



- Useful lightweight tapered containers with tight fitting LDPE lids
- Good chemical resistance
- Ideal for storage of samples, powders, animal feeds etc.

Product Code	Capacity (ml)	O.D. x height mm	Pack qty.
JWH0125P	125	80 x 40	250
JWH0250P	250	70 x 70	250
JWH0500P	400	70 x 90	100
JWH1000P	1000	90 x 120	100
JWH2000P	2000	140 x 150	50
JWH2500P	2500	170 x 150	25
JWH5000P	5000	200 x 210	25





Containers, specimen, LDPE



Azlon

- Containers with captive hinged cap suitable for many applications
- Lightweight and unbreakable in normal use
- Can withstand temperatures up to 80°C

Product Code	Capacity (ml)	O.D. x height mm	Pack qty.
BGG302	1	8 x 38	20
BGG304	2.5	12 x 40	20
BGG306	5	15 x 49	20
BGG308	10	28 x 32	10
BGG311	20	32 x 36	10
BGG312	25	25 x 78	10



Containers, specimen, polystyrene



Azlon

- Clear polystyrene containers with maximum sample visibility
- Polyethylene airtight snap-on lids for quick easy use

Product Code	Capacity (ml)	O.D. (mm)	Height mm	Pack qty.
BGG440P	10	26	28	10
BGG442P	20	32	33	10
BGG444P	30	36	33	10
BGG446P	50	36	53	10
BGG450P	100	51	60	10
BGG452P	150	65	53	10
BGG454P	200	65	88	10
BGG456P	250	65	87	5
BGG458P	500	100	100	5



Crucibles, Gooch

PYREX®

- Ideal for drying precipitates to constant mass at 110°C
- Also suitable for ignition work up to 450°C (see safety notice)
- With integral glass sintered disc
- Manufactured from chemically resistant Pyrex® borosilicate glass

Product Code	Nom. capacity ml	Sintered disc diam. mm	Porosity grade	Overall height mm	Pack qty.
3650/02M	10	20	1	45	5
3650/04M	10	20	2	45	5
3650/06M	10	20	3	45	5
3650/08M	10	20	4	45	5
3660/02M	30	30	1	53	5
3660/04M	30	30	2	53	5
3660/06M	30	30	3	53	5
3660/08M	30	30	4	53	5
3660/10M	30	30	5	53	5
3680/02M	60	40	1	65	5
3680/04M	60	40	2	65	5
3680/06M	60	40	3	65	5
3680/08M	60	40	4	65	5
3680/10M	60	40	5	65	5



Avoid sudden changes in temperature which can result in thermal breakage. For high temperature ignition work, use a furnace and slowly heat to 450°C maximum. Allow to cool below 200°C before removing from the furnace.



Crucible Adapter

PYREX®

- Allows Gooch crucibles to be fitted to a Büchner filter flask
- Useful for filtering and washing precipitates prior to drying

Product Code	To fit crucible	Open end I.D. mm	Height	Stem O.D. mm	Stem length mm	Pack qty.
3690/02M	3650:	30	60	9	75	10
3690/04M	3660:	37	68	9	75	10
3690/08M	3680:	47	78	9	75	10



For fitting a crucible onto the adapter, it is necessary to use a rubber cone as detailed on page 102.





Rubber cones



- For mounting Gooch crucibles onto Adapters 3690: series
- Manufactured from natural rubber
- Set of six sizes; 15, 22, 28, 36, 42 and 52mm I.D. at top
- May also be used for mounting filter funnels into Büchner flasks

Product Code	Description	Pack qty.
CON0006A	Set of 6 cones	1



Cutting board, polypropylene



- Autoclavable at 121°C
- Good chemical resistance
- Unbreakable in normal use
- Non-absorbent and easy to clean

Product Code	Overall dim. l x b x h mm	Pack qty.
BWY300	300 x 210 x 9	1



Cylinders, with spout, class A, works certified

PYREX®

- Complies with ISO 4788
- Calibrated to Class A tolerances
- Individually tested and supplied with certificate showing exact volume contained at 5 points on the scale
- Conformity 'H' certified
- Inscribed with individual serial number for batch certification
- Graduations in white enamel
- Manufactured from chemically resistant borosilicate glass with hexagonal foot

Product Code	Capacity (ml)	Grads. ml	Tol. ± ml	Max. height mm	Pack qty.
3201/02WC	5	0.1	0.05	115	2
3201/04WC	10	0.2	0.10	140	2
3201/06WC	25	0.5	0.25	170	2
3201/08WC	50	1.0	0.50	200	2
3201/10WC	100	1.0	0.50	260	2
3201/12WC	250	2.0	1.00	335	2
3201/14WC	500	5.0	2.50	390	2
3201/16WC	1000	10.0	5.00	470	2
3201/18WC	2000	20.0	10.00	570	1



i Batch certificate is available as free download at www.scilabware.com.

Cylinders, with spout, class A

PYREX®

- Complies with ISO 4788
- Calibrated to Class A tolerances
- Conformity 'H' certified
- Inscribed with serial number for downloadable batch certificate
- Graduations in white enamel
- Manufactured from chemically resistant Pyrex® borosilicate glass

Product Code	Capacity (ml)	Grads. ml	Tol. ± ml	Max. height mm	Pack qty.
3201/02	5	0.1	0.05	115	2
3201/04	10	0.2	0.10	140	2
3201/06	25	0.5	0.25	170	2
3201/08	50	1.0	0.50	200	2
3201/10	100	1.0	0.50	260	2
3201/12	250	2.0	1.00	335	2
3201/14	500	5.0	2.50	390	2
3201/16	1000	10.0	5.00	470	2
3201/18	2000	20.0	10.00	570	1



i Batch certificates can be downloaded from www.scilabware.com.



Cylinders, blue graduations, class B

MBL®

- Complies with ISO 4788
- Easy to read graduations in blue enamel
- Manufactured in chemically resistant borosilicate glass
- Robust hexagonal foot

Product Code	Capacity (ml)	Grads. ml	Tol. ± ml	Max. height mm	Pack qty.
CRC201	5	0.1	0.10	115	2
CRC202	10	0.2	0.20	140	2
CRC204	25	0.5	0.50	170	2
CRC206	50	1.0	1.00	200	2
CRC209	100	1.0	1.00	260	2
CRC211	250	2.0	2.00	335	2
CRC213	500	5.0	5.00	390	2
CRC214	1000	10.0	10.00	470	2
CRC216	2000	20.0	20.00	570	1



Cylinders, white graduations, class B

PYREX®

- Complies with ISO 4788
- Manufactured to Class B tolerances
- Robust hexagonal foot
- White enamel graduations which remain visible when using dark coloured solutions
- Manufactured from chemically resistant borosilicate glass

Product Code	Capacity (ml)	Grads. ml	Tol. ± ml	Max. height mm	Pack qty.
3200/02MP	5	0.1	0.10	115	2
3200/04MP	10	0.2	0.20	140	2
3200/06MP	25	0.5	0.50	170	2
3200/08MP	50	1.0	1.00	200	2
3200/10MP	100	1.0	1.00	260	2
3200/12MP	250	2.0	2.00	335	2
3200/14MP	500	5.0	5.00	390	2
3200/16MP	1000	10.0	10.00	470	2
3200/18MP	2000	20.0	20.00	570	1



Cylinders, tall form, heavy duty rim, class B

PYREX®

- Complies to ISO 4788
- Heavy duty construction for increased mechanical strength and longer life:
 - Heavily beaded rim and spout
 - Robust hexagonal foot
- Graduations in highly contrasting blue enamel
- Manufactured from Pyrex® borosilicate glass for high resistance to chemical attack

Product Code	Capacity (ml)	Grads. ml	Tol. ± ml	Max. height mm	Pack qty.
3280-50	50	1.0	1.00	200	2
3280-100	100	1.0	1.00	260	2
3280-250	250	2.0	2.00	335	2
3280-500	500	5.0	5.00	390	2
3280-1L	1000	10.0	10.00	470	2
3280-2L	2000	20.0	20.00	570	1



Cylinders, squat form, heavy duty rim, class B

PYREX®

- Complies with ISO 4788
- Squat height - more stable
- Heavy duty construction for increased mechanical strength and longer life:
 - Heavily beaded rim and spout
- More convenient to use in confined spaces - e.g. fume cupboards
- Graduations in blue enamel
- Manufactured from Pyrex® borosilicate glass

Product Code	Capacity (ml)	Grads. ml	Tol. ± ml	Max. height mm	Pack qty.
3285-10	10	1.0	0.30	75	2
3285-25	25	1.0	0.50	107	2
3285-50	50	1.0	1.00	140	2
3285-100	100	2.0	1.00	147	2
3285-250	250	5.0	2.00	212	2
3285-500	500	10.0	5.00	236	2
3285-1L	1000	20.0	10.00	293	1





Complete cylinder, glass body and foot

PYREX®

- Complies with ISO 4788
- Comprises Pyrex® glass cylinder and polyethylene foot
- Glass cylinder has white enamel graduations
- Polyethylene foot absorbs impact and reduces breakage
- Replacement feet available separately

Product Code	Capacity (ml)	Grads. ml	Tol. ± ml	Approx overall height mm	Pack qty.
3205/04MP	10	0.2	0.20	150	2
3205/06MP	25	0.5	0.50	175	2
3205/08P	50	1.0	1.00	195	2
3205/10P	100	1.0	1.00	270	2
3205/12P	250	2.0	2.00	320	2

Spare plastic feet

Product Code	Description	Pack qty.
4500/00	To fit cylinder capacity: 10ml	10
4500/01	To fit cylinder capacity: 25ml	10
4500/02M	To fit cylinder capacity: 50ml	10
4500/04M	To fit cylinder capacity: 100ml	10
4500/06M	To fit cylinder capacity: 250ml	10



Cylinder, with plastic stopper and detachable foot, class B, complete cylinder

PYREX®

- Complies with ISO 4788
- Comprises borosilicate glass cylinder polyethylene foot and polyethylene stopper
- Replacement parts available separately
- Graduations in white enamel

Product Code	Capacity (ml)	Grads. ml	Tol. ± ml	Stopper size	Pack qty.
3215/06MP	25	0.5	0.50	14/23	2
3215/08P	50	1.0	1.00	19/26	2
3215/10P	100	1.0	1.00	24/29	2
3215/12P	250	2.0	2.00	29/32	2

 For further details on the spare plastic feet see above.



Cylinder, with plastic stopper, hexagonal foot, blue graduations, class B

MBL®

- Complies with ISO 4788
- Supplied with polyethylene stopper
- Graduations in easy to read blue enamel
- Manufactured from borosilicate glass
- Robust hexagonal foot

Product Code	Capacity (ml)	Grads. ml	Tol. ± ml	Stopper size	Pack qty.
CRC302	10	0.2	0.20	10/19	2
CRC304	25	0.5	0.50	14/23	2
CRC306	50	1.0	1.00	19/26	2
CRC308	100	1.0	1.00	24/29	2
CRC310	250	2.0	2.00	29/32	2
CRC312	500	5.0	5.00	34/35	2
CRC314	1000	10.0	10.00	45/40	2
CRC316	2000	20.0	20.00	45/40	1



Cylinder, with glass stopper, hexagonal foot, white graduations, class B

PYREX®

- Complies with ISO 4788
- Supplied with interchangeable glass stopper
- Graduations in white enamel for improved visibility with dark coloured solutions
- Manufactured in chemically resistant Pyrex® borosilicate glass
- Robust hexagonal foot

Product Code	Capacity (ml)	Grads. ml	Tol. ± ml	Stopper size	Pack qty.
3211/04MP	10	0.2	0.20	10/19	2
3211/06MP	25	0.5	0.50	14/23	2
3211/08MP	50	1.0	1.00	19/26	2
3211/10MP	100	1.0	1.00	24/29	2
3211/12MP	250	2.0	2.00	29/32	2
3211/14MP	500	5.0	5.00	34/35	2
3211/16MP	1000	10.0	10.00	45/40	2
3211/18MP	2000	20.0	20.00	45/40	1



i For spare glass stoppers, please refer to page 247.



Cylinders, Nessler

MBL®

- For colour comparison of water samples etc.
- Manufactured from borosilicate tubing specially selected for freedom from colour or visible defects
- Cylinder bases are formed by a technique which gives maximum clarity
- Supplied in matched pairs for uniformity

Product Code	Capacity (ml)	Grads. ml	Tol. ± ml	O.D. x height mm	Pack qty.
CRC320	50	50	0.40	26 x 150	2
CRC322	100	50 & 100	0.80	34 x 180	2



Receivers, Crow, class B

PYREX®

- Complies with BS 658
- For the collection of distillate in oil and tar tests
- Graduations in white enamel
- Manufactured from Pyrex® borosilicate glass

Product Code	Capacity (ml)	Grads. ml	Overall height mm	Pack qty.
3400/04	100	1	250	2

LIPSOL® LABWARE DETERGENT

- Excellent cleaning performance - ideal for use with laboratory glassware and plasticware
- Great value for money
- Totally biodegradable

For full details see page 89





Cylinders, squat form, class B, polypropylene,



Azlon

- Squat design for increased stability on the bench and ease of handling particularly in restricted spaces
- Unique self-draining base eliminating water collection during washing in an automatic lab washing machine, thereby removing all spill and contamination issues
- Moulded, blue over-printed graduations
- Manufactured from high clarity polypropylene
- Good chemical and temperature resistance
- Anti-suction base stops cylinders slipping on a wet surfaces

Product Code	Capacity (ml)	Grads. ml	Tol. \pm ml	Height mm	Pack qty.
CPS0100P	100	2.0	2.00	163	5
CPS0250P	250	5.0	5.00	192	1
CPS0500P	500	10.0	10.00	218	1
CPS1000P	1000	20.0	20.00	285	1



Exposure to temperatures up to 80°C will not cause permanent exceeding of tolerance limits. Cleaning temperatures below 60°C is recommended to preserve marks and inscriptions.



Cylinders, printed graduations, class B, polypropylene



Azlon

- Conform to ISO 6706
- Clear pin sharp blue graduations
- Ultra clear polypropylene with good chemical resistance
- Stable hexagonal bases with non slip anti-suction feature

Product Code	Capacity (ml)	Grads. ml	Tol. \pm ml	Height mm	Pack qty.
CPB0010P	10	0.2	0.20	140	10
CPB0025P	25	0.5	0.50	170	10
CPB0050P	50	1.0	1.00	200	10
CPB0100P	100	1.0	1.00	250	5
CPB0250P	250	2.0	2.00	315	1
CPB0500P	500	5.0	5.00	360	1
CPB1000P	1000	10.0	10.00	440	1
CPB2000P	2000	20.0	20.00	535	1



Exposure to temperatures above 80°C may affect accuracy.





Exposure to temperatures above 80°C may affect accuracy.

Cylinders, moulded graduations, class B, polypropylene



Azlon

- Conform to ISO 6706
- Ultra clear polypropylene with good chemical resistance
- Large pouring spout for easy dispensing
- Stable hexagonal bases with non slip anti-suction feature
- Permanent moulded graduations

Product Code	Capacity (ml)	Grads. ml	Tol. \pm ml	Height mm	Pack qty.
CP0010P	10	0.2	0.20	140	10
CP0025P	25	0.5	0.50	170	10
CP0050P	50	1.0	1.00	200	10
CP0100P	100	1.0	1.00	250	5
CP0250P	250	2.0	2.00	215	1
CP0500P	500	5.0	5.00	360	1
CP1000P	1000	10.0	10.00	440	1
CP2000P	2000	20.0	20.00	535	1

Cylinders, moulded graduations, set, class B, polypropylene

Product Code	Description	Pack qty.
NB1203	Set of 6 cylinders comprising (1x 10, 25, 50, 100, 250 & 500ml)	1



Cylinders, printed graduations, class A, PMP (TPX)



Azlon

- Calibrated to ISO 6706 and DIN 12681, class A tolerances
- Steam sterilisation at 121°C does not affect accuracy
- Supplied with conformity certificate
- Enhanced pin sharp blue printed graduations
- Stable hexagonal bases with non-slip anti-suction feature

Product Code	Capacity (ml)	Grads. ml	Tol. +/- ml	Height mm	Pack qty.
CTA0010P	10	0.2	0.1	140	2
CTA0025P	25	0.5	0.2	170	2
CTA0050P	50	1.0	0.5	200	2
CTA0100P	100	1.0	0.5	250	2
CTA0250P	250	2.0	1	315	2
CTA0500P	500	5.0	2.5	360	2
CTA1000P	1000	10.0	5	440	1
CTA2000P	2000	20.0	1	535	1



Cylinders, printed graduations, class B, PMP (TPX)



- Calibrated to ISO 6706 and DIN 12681, class B tolerances
- Steam sterilisation at 121°C does not affect accuracy
- Enhanced pin sharp blue printed graduations
- Stable hexagonal bases with non-slip anti-suction feature

Product Code	Capacity (ml)	Grads. ml	Tol. +/- ml	Height mm	Pack qty.
CTB0010P	10	0.2	0.2	140	10
CTB0025P	25	0.5	0.5	170	5
CTB0050P	50	1.0	1	200	5
CTB0100P	100	1.0	1	250	5
CTB0250P	250	2.0	2	315	1
CTB0500P	500	5.0	5	360	1
CTB1000P	1000	10.0	10	440	1
CTB2000P	2000	20.0	20	535	1



Cylinders, moulded graduations, class B, PMP (TPX)



- Conform to ISO 6706
- Transparent robust PMP
- Good chemical resistance
- Large pouring spout for easy dispensing
- Autoclavable to 121°C

Product Code	Capacity (ml)	Grads. ml	Tol. +/- ml	Height mm	Pack qty.
CT0010P	10	0.2	0.2	140	10
CT0025P	25	0.5	0.5	170	5
CT0050P	50	1.0	1	200	5
CT0100P	100	1.0	1	250	5
CT0250P	250	2.0	2	315	1
CT0500P	500	5.0	5	360	1
CT1000P	1000	10.0	10	440	1
CT2000P	2000	20.0	20	535	1





i Complete desiccators consist of a base and cover. Not supplied with metal perforated plate. See bottom of the page for information on this product.

Desiccators, non-vacuum

PYREX®

- Robust desiccator base and cover in borosilicate glass
- Simple design for drying under atmospheric pressure
- Ground glass flanges
- Choice of 2 sizes - to accommodate 150mm or 200mm diameter plates
- Plates are positioned on an internal ledge within the base
- Accessory metal perforated plate available

Product Code	Description	Flange I.D. mm	Plate size mm	Height, ledge to flange mm	Pack qty.
1590/02D	Complete desiccator	170	150	85	1
1590/04D	Spare cover	170	-	-	1
1590/06D	Spare base	170	150	85	1
1591/02D	Complete desiccator	220	200	120	1
1591/04D	Spare cover	220	-	-	1
1591/06D	Spare base	220	200	120	1



Desiccators, vacuum

PYREX®

- Designed for use under vacuum
- Sturdy construction in borosilicate glass
- Ground glass flanges
- Cover has a 24/29 socket to accept desiccator stopcocks
- Choice of 2 sizes - to accommodate 150mm or 200mm diameter plates
- Plates are positioned on an internal ledge within the base
- Accessory metal perforated plate and Rotaflo® glass/PTFE stopcock available

Product Code	Description	Flange I.D. mm	Plate size mm	Height, ledge to flange mm	Socket size	Pack qty.
1593/02D	Complete desiccator	170	150	85	24/29	1
1593/04D	Spare cover	170	-	-	24/29	1
1594/02D	Complete desiccator	220	200	120	24/29	1
1594/04D	Spare cover	220	-	-	24/29	1

i Complete desiccators consist of a base, cover and stopcock. Not supplied with metal perforated plate.

Desiccator plate

- Metal perforated plate for use with Pyrex® vacuum and non-vacuum desiccators

Product Code	Plate size mm	Pack qty.
1597/02D	150	1
1597/04D	200	1



Desiccator stopcock

PYREX®

- For use with Pyrex® vacuum desiccators
- With Rotafllo® stopcock for vacuum tight seal

Product Code	Joint size	Pack qty.
1612/03	24/29	1



Desiccators, vacuum, polycarbonate

- Transparent polycarbonate cover and base
- Durable with high impact resistance
- Will safely withstand high vacuum pressures
- Ceramic plate permits the use of incandescent crucibles



Azlon

Product Code	Description	I.D. mm	Plate size mm	Overall height mm	Effective inside height mm	Pack qty.
DWA215	With stopcock	215	205	262	178	1
DWA245	With stopcock	245	236	296	195	1
DWA246	Without stopcock	245	236	296	195	1



Desiccators, vacuum, polycarbonate, spares

Product Code	Description	Pack qty.
DWA205	Spare plate for DWA 215	1
DWA236	Spare plate for DWA245/246	1
DWA510	Spare stopcock for DWA215/245	1

Desiccator, cabinet, polystyrene

- Provides moisture-proof storage
- Clear high impact polystyrene cabinet
- Space saving stacking feature
- Airtight door with foam rubber gasket
- Supplied with sealed jar of silica gel



Azlon

Product Code	Int. l x w x h mm	Ext. l x w x h mm	Door opening mm	Pack qty.
DWA301	210 x 180 x 130	225 x 200 x 168	188 x 110	1



Not suitable for vacuum use or filling with gases.



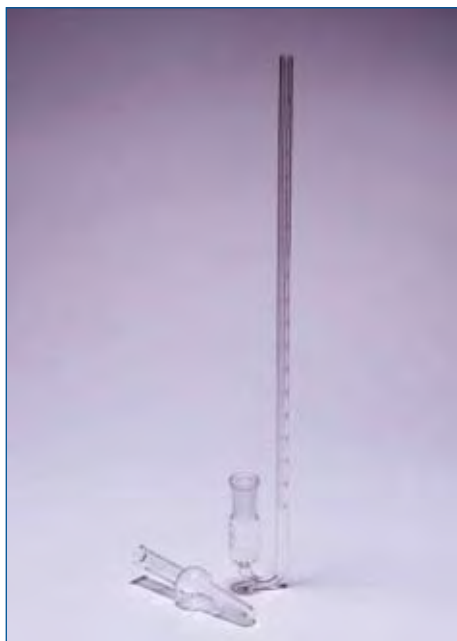

Dilatometer

- For measuring the expansion of edible oils and fats over the temperature range within which melting takes place
- Dilatometer body is graduated with an arbitrary scale
- Interchangeable stopper has open top to allow weighting with steel balls etc.

Product Code	Description	Socket size	Cone size	Pack qty.
SB14DL	Stopper	-	14/23	1
WE12/1	Dilatometer body	14/23	-	1

 *The body and stopper should be ordered separately.*

AZLON® SQUAT FORM MEASURING CYLINDERS

- Low height improves stability on lab bench
- Easier to manoeuvre in fume cupboards
- Robust polypropylene construction
- Unique drainage hole for problem-free washing

For full details see CPS: range on page 109



Attention Attention Achtung Atención



The new Azlon® multi-lingual wash bottle gives you chemical names and safety instructions in four European languages - English, French, German and Spanish.

We've also updated the design to reflect the very latest changes in European labelling legislation (GHS) including new hazard warning pictograms.

Plus, of course, you get all of the regular features and benefits this highly popular laboratory essential, including Driplok® vapour venting technology.

Our unique patented two-way valve lets the vapour escape when pressure builds up and stops air getting into the liquid.

The result - no more hazardous drips or dribbles and an accurate, continuous dispensing stream.

To find out more about the full range of Azlon multi-lingual wash bottles, please see page 69 or visit our website www.scilabware.com

Azlon

SciLabware Ltd., Beacon Road, Stone, Staffordshire, ST15 0SA UK
Tel: +44 (0)844 936 0231 Fax: (0)844 936 0232 www.scilabware.com

 SciLabware
AZLON® IIBL® PYREX® QUICKFIT®



Crystallising dishes, flat bottom

PYREX®

- Complies to DIN 12337
- Manufactured from Pyrex® borosilicate glass
- Suitable for use up to 400°C
- Chemically and thermally resistant

Product Code	Capacity (ml)	Diam. mm	Height mm	Pack qty.
1470/03M	15	40	25	10
1470/00M	30	52	30	10
1470/01M	60	58	35	10
1470/02D	100	70	40	10
1470/04D	150	80	45	10
1470/08D	300	95	55	10
1470/10D	500	115	65	10
1470/12D	900	140	75	10
1470/16D	2000	190	90	10



Crystallising dishes, flat bottom, with spout

PYREX®

- Complies to DIN 12337
- Manufactured from Pyrex® borosilicate glass
- Suitable for use up to 400°C
- Chemically and thermally resistant

Product Code	Capacity (ml)	Diam. mm	Height mm	Pack qty.
1471/03M	15	40	25	10
1471/00M	30	52	30	10
1471/01M	60	58	35	10
1471/02M	100	70	40	10
1471/04M	150	80	45	10
1471/08M	300	95	55	10
1471/10M	500	115	65	10
1471/12M	900	140	75	10
1471/16M	2000	190	90	10



Evaporating dishes

PYREX®

- Complies to DIN 12336
- Manufactured from Pyrex® borosilicate glass
- High resistance to chemical attack and thermal shock
- Flat base
- Curved sides with spout

Product Code	Capacity (ml)	Diam. mm	Height mm	Pack qty.
1450/01D	15	50	25	10
1450/03D	45	60	30	10
1450/04D	90	80	45	10
1450/06D	170	95	55	10
1450/10D	320	115	65	10
1450/14D	600	140	80	10



i 1450/01D & 1450/03D are unbadged.

Dishes, general purpose

PYREX®

- Manufactured from chemically resistant Pyrex® borosilicate glass
- Ideal for numerous applications:
 - Drying powders and crystals
 - Staining and development
 - Collection of drips and spills from solution bottles
 - Gel electrophoresis and paper chromatography
 - Dissection work
- Dishes can be autoclaved or used in microwave ovens

Product Code	Capacity (ml)	Length (mm)	Width mm	Height mm	Pack qty.
1490/02	2000	275	200	51	4
1490/04	2000	300	210	60	4
1490/06	3500	337	230	57	4
1490/08	4500	389	270	57	4



i Dimensions are approximate.



i Pestles and mortars should be ordered separately.

Pestle

PYREX®

- Ideal for crushing solids into powders for easier handling
- Manufactured from Pyrex® borosilicate glass for highest resistance to thermal shock and chemical corrosion
- Available in a rough or glazed finish
- For use with Pyrex® Mortars

Product Code	Finish	Length (mm)	Pack qty.
718342	Rough	110	1
718342R	Glazed	110	1
718347	Rough	125	1
718347R	Glazed	125	1

Mortar

PYREX®

- Manufactured from Pyrex® borosilicate glass for highest resistance to thermal shock and chemical corrosion
- For use with Pyrex® Pestle
- Ideal for preparing compounds, mixing and grinding powders

Product Code	Capacity (ml)	O.D. mm	Height mm	Pack qty.
718234	100	80	60	1
718242	120	100	75	1
718247	300	120	90	1



Petri dishes

PYREX®

- Specially formed to ensure even wall thickness and consistent optical performance
- Will withstand repeated autoclaving
- Manufactured from chemically resistant Pyrex® borosilicate glass

Product Code	Size (mm)	Base ext. dia mm	Cover int. dia mm	Pack qty.
1480/02D	60 x 20	54	55	10
1480/06D	80 x 20	74	75	10
1480/08D	100 x 20	94	95	10
1480/10D	120 x 20	144	115	10
1480/12D	150 x 30	143	145	10



Dishes, photographic, white PVC



- Lightweight PVC trays, unbreakable in normal use, do not chip and are easily cleaned
- Accepts standard photographic paper
- Ribbed with pouring lip

Product Code	Internal dim. l x w mm	Height mm	Pack qty.
DWR006	260 x 200	65	1
DWR007	300 x 250	62	1
DWR008	420 x 320	75	1
DWR010	510 x 425	75	1
DWR012	650 x 520	90	1

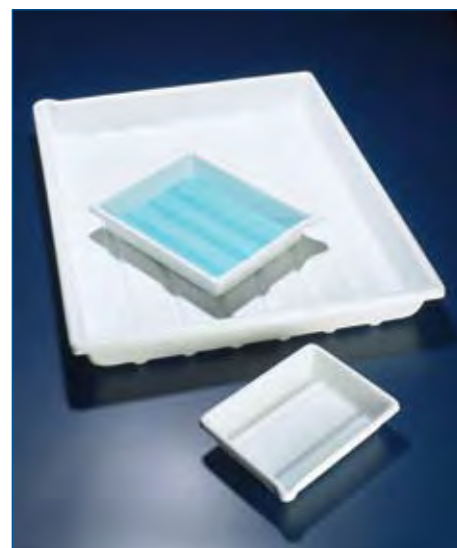

Dispensers, tilt measure, variable volume



- Ideal for dispensing fixed volumes of liquids
- Very easy to use
 - Tilt the unit backwards to fill
 - Tilt the unit forwards to dispense
- Accuracy of $\pm 5\%$ can be achieved
- Fits any vessel with a 24/29 socket
- Manufactured from chemically resistant borosilicate glass

Product Code	To accept inner measures ml	Cone size	Thread size	Pack qty.
TM28/23	5ml or 10ml	24/29	28	1
TM28/43	20ml or 25ml	24/29	28	1

i Comprises outer body which accepts choice of inner measures: TM28/23 for use with either 5ml or 10ml inner measures or TM28/43 for use with either 20ml or 25ml inner measures.

Inner tilt measures

Product Code	Capacity (ml)	Pack qty.
TM11/5	5	1
TM11/10	10	1
TM11/20	20	1
TM11/25	25	1





Extractors, soxhlet



- Conforms to BS 2071
- For extracting soluble components or impurities from solids via repeated soaking/siphoning with solvent
- Wide choice of extractors to accommodate most sizes of sample and thimbles
- Accurately formed concentric siphon tube for reliable performance

Product Code	Nom. capacity (siphoning vol.) ml	Socket size	Cone size	Approx overall height (mm)	Pack qty.
EX5/21	6	19/26	14/23	150	1
EX5/32	20	24/29	19/26	175	1
EX5/43	40	29/32	24/29	200	1
EX5/53	60	34/35	24/29	205	1
EX5/55	60	34/35	34/35	205	1
EX5/55/100	100	34/35	34/35	240	1
EX5/63	100	40/38	24/29	220	1
EX5/83	200	50/42	24/29	250	1

i Approximate overall height is measured from the wide end of the cone.



Extractors, soxhlet, large capacity



- Conforms to BS 2071
- Large capacity extractors
- With flat flange joints to permit introduction of large samples
- Used in conjunction with flat flange lid and retaining clip which should be ordered separately

Product Code	Nom. capacity (siphoning vol.)	Extractor flange size mm	Extractor cone size	Pack qty.
EX5/75	600	75	34/35	1
EX5/105	2000	100	34/35	1

Lids for large capacity soxhlet extractor

Product Code	Description	Socket size	Pack qty.
DA5/75	Lid for EX5/75	34/35	1
DA5/100	Lid for EX5/105	34/35	1

Metal clip for large capacity soxhlet extractor

Product Code	Description	Pack qty.
JC75F	Metal clip for EX5/75	1
JC100F	Metal clip for EX5/105	1



Extractors, plain body



- Designed for use in reflux assemblies so that solvent vapour permeates directly through the material to be extracted then condenses and washes back into the flask
- Sample can be supported directly on glass spiral or in a paper or glass thimble

Product Code	Nom. capacity ml	Socket size	Cone size	Approx overall height (mm)	Pack qty.
EX7/13	60	34/35	24/29	205	1
EX7/33	200	55/44	24/29	250	1



Approximate overall height is measured from the wide end of the cone.



Take care that the sample or thimble does not totally block the passage of rising vapour and falling condensate.



Extractors, spiral support

Product Code	Description	Diam. mm	Pack qty.
EX13/25	To fit EX7/13	29	1
EX13/26	To fit EX7/33	35	1

Extractors, paper thimbles

- Paper thimbles are the most common type used in liquid/solid extractors and although not available from SciLabware, are readily obtained from most laboratory suppliers. Recommended sizes for the Quickfit® range of extractors are as follows:

Product Code	Recommended thimble size mm	Pack qty.
EX5/21	10 x 50	1
EX5/32	18 x 65	1
EX5/43	22 x 80	1
EX5/53	28 x 80	1
EX5/55	28 x 80	1
EX5/55/100	28 x 120	1
EX5/63	33 x 100	1
EX5/75	60 x 160	1
EX5/83	41 x 123	1
EX5/105	70 x 240	1
EX7/13	27 x 100	1
EX7/33	33 x 100	1



The dimensions are internal and are given for single thickness thimbles only. If double thickness thimbles are used, the internal diameter should be 2mm less to allow for greater wall thickness. Alternatively, thimbles made from borosilicate glass are available on page 122.



Glass thimbles

PYREX®

- Borosilicate glass with sintered glass disc to support solid sample
- Highly resistant to chemical attack
- Useful for chemical applications where it is required to weigh the extracted material

Product Code	Porosity grade	Disc diam. mm	O.D. mm	Overall length mm	Pack qty.
3840/02M	1	20	26	95	5
3845/02M	1	30	36	95	5

i 3840: thimbles fit Quickfit® extractors EX5/53 and EX5/55. 3845: thimbles fit Quickfit® extractors EX5/63 and EX5/83.

CUSTOM GLASSWARE MANUFACTURE

- Free quotation without obligation
- Highest quality guaranteed
- All enquiries welcome

Tel: +44 (0)1785 812121
 Fax: +44 (0)1785 815066
 Email: customglass@scilabware.com





Extractors, soxhlet, complete assemblies



- Each assembly comprises the basic components for solid-liquid extraction : Flask/Soxhlet extractor/Condenser/Associated lids and clips
- Choice of 7 assemblies with extractor capacities from 20ml to 2000ml

Product Code	Nom. capacity ml	Components extractor etc	Flask	Condenser	Pack qty.
25RASX	20	EX5/32	FR50/2S	CX7/03/SC	1
40RASX	40	EX5/43	FR100/3S	CX7/04/SC	1
60RASX	60	EX5/53	FR150/3S	CX7/05/SC	1
100RASX	100	EX5/63	FR250/3S	CX7/06/SC	1
200RASX	200	EX5/83	FR500/3S	CX7/08/SC	1
600RDSX	600	EX5/75, DA5/75, JC75F	FR2L/5S	CX5/25/SC	1
2LRCSX	2000	EX5/105, DA5/100, JC100F	FR5L/5US	C13/55	1

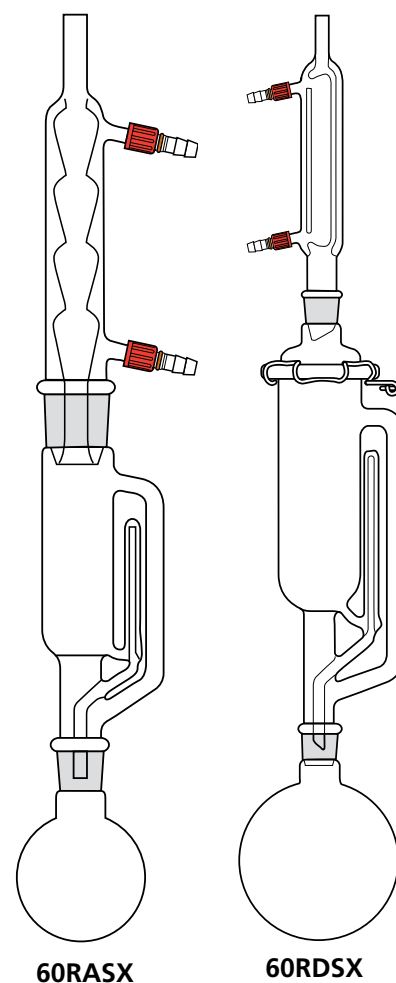

60RASX

60RDSX

Extractors, liquid-liquid, heavy phase, small capacity



- For use with heavy phase solvents i.e. solvents with a heavier specific gravity than the sample liquid being extracted
- Comprises extractor body and baffle which should be ordered separately
- Designed for continuous operation
- Condensed solvent falls onto the baffle and is broken into small droplets
- Droplets of solvent descend through the liquid sample and extract desired components/contamination
- Solvent then returns to the boiling flask via a tube on the side of the extractor

Product Code	Nom. capacity ml	Socket size	Cone size	Approx overall height mm	Pack qty.
EX10/23	60	34/35	24/29	250	1

i This extractor can be used with a variety of Quickfit® flasks and condensers e.g. FR250/3S and CX7/05/SC.

Extractors, baffle

Product Code	Description	Pack qty.
EX10/20	Baffle to fit EX10/23 extractor	1





i For further information regarding porosities, safe usage and cleaning please refer to the technical information section.

Filter discs

PYREX®

- Complies with ISO 4793
- For use by glassblowers constructing special apparatus
- Manufactured from Pyrex® borosilicate glass for resistance to heat and chemical corrosion
- Close control of pore size
- Accurate and consistent disc dimensions
- High mechanical strength to withstand full vacuum

Product Code	Porosity grade	Nom. diam.mm	Pack qty.
3010/10M	0	10	10
3020/10M	0	20	10
3030/10M	0	30	10
3040/10M	0	40	10
3050/10M	0	50	10
3090/10M	0	90	1
3010/11M	1	10	10
3020/11M	1	20	10
3030/11M	1	30	10
3040/11M	1	40	10
3050/11M	1	50	10
3065/11M	1	65	1
3090/11M	1	90	1
3120/11M	1	120	1
3010/12M	2	10	10
3020/12M	2	20	10
3030/12M	2	30	10
3040/12M	2	40	10
3050/12M	2	50	10
3065/12M	2	65	1
3090/12M	2	90	1
3120/12M	2	120	1
3010/13M	3	10	10
3020/13M	3	20	10
3030/13M	3	30	10
3040/13M	3	40	10
3050/13M	3	50	10
3065/13M	3	65	1
3090/13M	3	90	1
3120/13M	3	120	1
3010/14M	4	10	10
3020/14M	4	20	10
3030/14M	4	30	10
3040/14M	4	40	10
3050/14M	4	50	10
3065/14M	4	65	1
3090/14M	4	90	1
3120/14M	4	120	1



Filter holder, for 25mm membranes

- With sintered glass disc to support 25mm diameter membranes
- Liquids only in contact with chemically resistant borosilicate glass
- Comprises three components which should be ordered separately
 - Funnel 15ml capacity
 - Support base with sintered glass disc
 - Metal retaining clip
- Fully autoclavable

Product Code	Description	Pack qty.
5808/2	Funnel	1
5808/3	Base	1
9830/29M	Clip	1

PYREX®



Filter holder, for 47mm membranes

- With sintered glass disc to support 47mm diameter membranes
- All borosilicate glass liquid pathway to avoid sample contamination
- Comprises three components which should be ordered separately
 - Funnel 300ml capacity
 - Support base with sintered glass disc
 - Metal retaining clip
- Fully autoclavable
- Ideal for microbiology

Product Code	Description	Pack qty.
5809/2	Funnel	1
5809/3	Base	1
5810/5	Clip	1

PYREX®





Filtration system, for 47mm diameter membranes

PYREX®

- All glass filtration system for use with 47mm diameter membranes
- Borosilicate glass sintered disc to support membrane
- Comprises four components which should be ordered separately
 - Funnel 300ml capacity
 - Support base with sintered disc and vacuum connection
 - Metal retaining clip
 - 1000ml conical flask suitable for use under vacuum
- Fully autoclavable
- Ideal for microbiology

Product Code	Description	Pack qty.
5809/2	Funnel	1
5810/3	Base	1
5810/4	Flask	1
5810/5	Clip	1



Filter pump

MBL®

- Provides a moderate vacuum (up to 65 mbar) when connected to a water supply
- Fitted with a non-return valve to prevent suck-back and flooding
- Manufactured from chemically resistant borosilicate glass

Product Code	Overall height mm	Body diam. mm	Pack qty.
FRF442	240	20	1



Recommended water pressure = 1 bar. Approximate water consumption = 17 l/hr.



Flasks, boiling, flat bottom, narrow neck

PYREX®

- Complies with ISO 1773
- Flat base for standing on benches and hotplates etc.
- Manufactured from Pyrex® glass for high resistance to thermal shock
- Excellent chemical durability for contamination-free performance
- With white enamel marking spot

Product Code	Capacity (ml)	Height mm	Body diam. mm	Neck I.D. mm	Pack qty.
1070/02M	50	100	50	18	10
1070/04D	100	110	64	18	10
1070/12D	250	140	85	30	10
1070/18D	500	170	105	30	10
1070/24D	1000	200	131	36	10
1070/28D	2000	250	166	45	10
1070/32D	4000	300	207	45	1
1070/36D	6000	340	237	57	1
1070/38D	10000	360	280	57	1
1070/40D	12000	465	300	57	1
1070/42D	20000	558	341	60	1



i 12000ml and 20000ml flasks are supplementary to the ISO range.

Flasks, boiling, flat bottom, wide neck

PYREX®

- Complies with ISO 24450
- With wide neck to facilitate easy addition of solid samples etc.
- Flat base for standing on benches and hotplates etc.
- Manufactured from Pyrex® glass for high resistance to thermal shock
- Excellent chemical durability for contamination-free performance

Product Code	Capacity (ml)	Height mm	Bulb diam. mm	Neck I.D. mm	Pack qty.
1080/02M	50	75	52	32	10
1080/04M	100	100	64	32	10
1080/08D	250	140	84	47	10
1080/10D	500	170	103	47	10
1080/12D	1000	200	131	47	10
1080/14D	2000	230	166	76	10

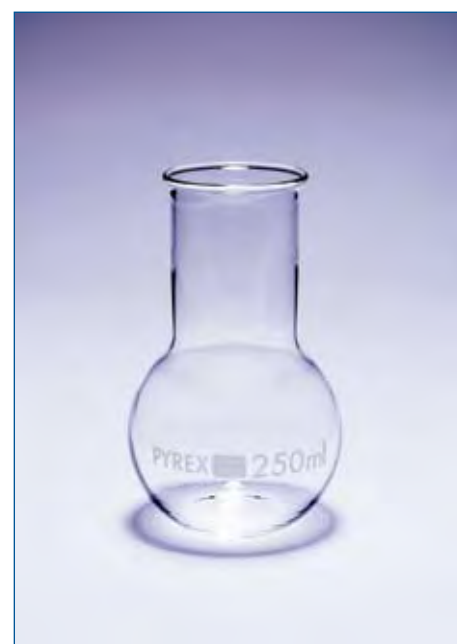

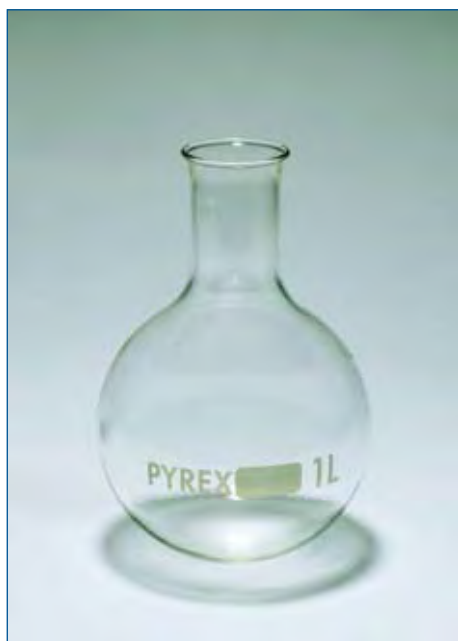

Flasks, boiling, round bottom, narrow neck

PYREX®

- Complies with ISO 1773
- Manufactured from Pyrex® borosilicate glass which offers excellent resistance to chemical corrosion and thermal shock

Product Code	Capacity (ml)	Height mm	Bulb diam. mm	Neck I.D. mm	Pack qty.
1100/02M	50	105	50	18	10
1100/04M	100	115	65	18	10
1100/12D	250	144	85	30	10
1100/18D	500	175	105	30	10
1100/24D	1000	200	131	36	10
1100/28D	2000	260	166	45	10
1100/32D	4000	315	207	45	1
1100/35D	6000	355	236	57	1
1100/36D	10000	420	279	57	1
1100/38D	20000	515	345	67	1

i 20000ml flask is supplementary to the ISO range.
For information on the safe heating of Pyrex® glassware, please see the care and maintenance of glassware section.

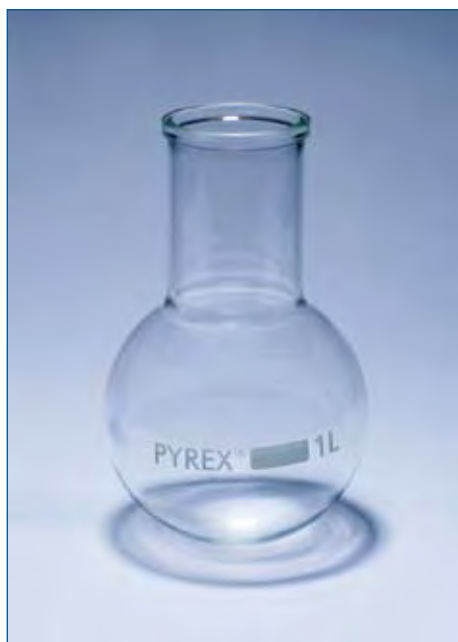

Flasks, boiling, round bottom, wide neck

PYREX®

- Complies with ISO 24450 and DIN 12353
- With wide neck to facilitate addition of solid samples etc.
- Pyrex® glass means highest resistance to chemical corrosion and thermal shock

Product Code	Capacity (ml)	Height mm	Bulb diam. mm	Neck I.D. mm	Pack qty.
1120/04M	100	100	65	30	10
1120/08D	250	145	85	46	10
1120/14D	500	168	105	46	10
1120/18D	1000	210	131	60	10
1120/22D	2000	260	165	70	10
1120/26D	4000	315	206	70	1
1120/29D	6000	355	236	80	1

i Sizes 1000ml and above have tooled rim for greater durability.



Flasks, conical, narrow neck

PYREX®

- Complies with ISO 1773 and DIN 12353
- Erlenmeyer pattern
- Manufactured from Pyrex® borosilicate glass for highest resistance to thermal shock and chemical corrosion

Product Code	Capacity (ml)	Body O.D. mm	Height mm	Neck I.D. mm	Pack qty.
1130/03	5	25	52	12	10
1130/05M	10	30	60	12	10
1130/11M	25	42	70	18	10
1130/02M	50	51	85	18	10
1130/06D	100	64	105	18	10
1130/10D	150	74	118	28	10
1130/12D	200	79	131	34	10
1130/14D	250	85	145	34	10
1130/16D	300	87	156	34	10
1130/20D	500	105	180	34	10
1130/26D	1000	131	220	42	10
1130/30D	2000	166	280	50	10
1130/32D	3000	187	310	52	2
1130/36D	5000	220	365	52	1



i 5, 10, 150, 200, 300 and 5000ml flasks are supplementary to the ISO range.

Flasks, conical, narrow neck, heavy duty

PYREX®

- Mechanically stronger than standard flasks
- Designed for longer life and increased user safety
- Reinforced rims to reduce chipping and breakage

Product Code	Capacity (ml)	Height mm	Body O.D. mm	Neck I.D. mm	B.S. stopper size	Pack qty.
4980-10	10	50	31	10	10	12
4980-25	25	65	41	13	13	12
4980-50	50	78	51	14	14	12
4980-125	125	114	67	23	23	12
4980-250	250	132	82	27	27	12
4980-500	500	176	101	31	31	6
4980-1L	1000	216	129	37	37	6
4980-2L	2000	268	160	43	43	1
4980-4L	4000	360	206	43	43	1
4980-6L	6000	410	235	43	43	1



! If using Pyrex® conical flasks to prepare culture media or to heat viscous solutions, remember to stir the solution regularly to dissipate the heat. Failure to observe this procedure can result in thermal breakage.



Flasks, conical, wide neck

PYREX®

- Complies with ISO 24450
- Erlenmeyer pattern
- Manufactured from Pyrex® borosilicate glass
- Excellent thermal performance
- High resistance to chemical attack
- White enamel graduations and marking spot

Product Code	Capacity (ml)	Body O.D. mm	Height mm	Neck I.D. mm	Pack qty.
1140/02M	50	48	85	30	10
1140/04D	100	64	110	30	10
1140/08D	250	85	140	46	10
1140/10D	500	105	175	46	10
1140/14D	1000	131	220	46	10
1140/18D	2000	153	275	66	10

i 2000ml size is supplementary to ISO range.



Flasks, conical, wide neck, heavy duty

PYREX®

- Mechanically stronger than conventional Erlenmeyers
- Reinforced rims for extra strength and resistance to impact fracture
- Manufactured from high quality Pyrex® borosilicate glass
- White graduations and marking spot

Product Code	Capacity (ml)	Height mm	Body O.D. mm	Neck I.D. mm	B.S. stopper size	Pack qty.
5100-125	125	109	66	27	27	12
5100-250	250	134	81	33	33	12
5100-500	500	170	97	43	43	6
5100-1L	1000	219	122	48	48	6
5100-2L	2000	279	156	58	58	1





NEW

Flasks, conical, cylindrical

PYREX®

- Manufactured from Pyrex® borosilicate glass for the highest resistance to thermal shock and chemical corrosion
- Ideal for fermentation and culture work
- White enamel marking spot
- Autoclavable

Product Code	Capacity (ml)	Body O.D. mm	Neck O.D. mm	Height mm	Pack qty.
1190/02M	60	45	25	70	10
1190/04M	125	60	30	97	10
1190/06M	250	69	34	130	10
S/3L5895	500	90	35	154	5



Flasks, conical, baffled

PYREX®

- Ideal for use in preparation of cultures
- Manufactured from Pyrex® borosilicate glass
- Exhibits 4 baffle indents to provide optimal and consistent agitation

Product Code	Capacity (ml)	Body O.D. mm	Height mm	Neck I.D. mm	Pack qty.
1134/08	250	82	138	32	5
1134/10	500	101	186	36	5
1134/12	1000	129	222	43	2
1134/14	2000	161	282	49	1





Flasks, culture

PYREX®

- Ideal for use in preparation of cultures
- Compatible with shaker equipment
- Long, rimless tube neck for use with closures
- Manufactured from Pyrex® borosilicate glass with white enamel markings

Product Code	Capacity (ml)	Body O.D. mm	Height mm	Neck O.D. mm	Pack qty.
1135/14D	250	85	148	38	10
1135/20D	500	105	183	38	5
1135/26D	1000	131	229	38	2
1135/30D	2000	166	302	38	1

 Compatible with either Aluminium or polypropylene closures listed on page 133.



1138/10

Flasks, Fernbach, culture

PYREX®

- For use in preparation of cultures
- Large surface area to volume ratio
- Manufactured from Pyrex® borosilicate glass
- Exhibit 3 baffle indents to provide optimal and consistent agitation
- Available in two versions
 - Delong neck, for use with 4540/38P and 4550/38M caps
 - Screwcap, with Polypropylene GL45 thread cap

Product Code	Description	Capacity (ml)	Pack qty.
1138/10	Delong neck	2800	2
1139/10	Screwcap	2800	2



1139/10



NEW

Culture flask closures

- For use with 1135 culture flasks and 1138/10 Fernbach flasks
- Two types of cap
 - Anodised aluminium
 - 2-position polypropylene
- Both caps are suitable for autoclaving

Product Code	Description	Cap I.D. mm	Pack qty.
4550/38M	Aluminium	38	10
4540/38P	Polypropylene	38	10



Flasks, conical, screwcap

PYREX®

- Ideal for storage of culture specimens and media
- Phenolic screwcaps with PTFE faced sealing disc

Product Code	Capacity (ml)	Body O.D. mm	Flask height mm	Cap size	Pack qty.
1137/11M	5	25	57	15	10
1137/12M	10	30	68	15	10
1137/13M	25	42	76	22	10
1137/02M	50	51	85	22	10
1137/03D	100	64	105	30	10
1137/06M	250	85	130	42	10
1137/08D	500	105	160	42	10
1137/10M	1000	131	210	42	1
1137/14M	2000	166	280	42	5
1137/18M	3000	187	315	42	5



If sterilising flasks by steam or dry heat, the screwcap must NOT be fully tightened. Slacken off first. Failure to follow this procedure can result in pressure build-up and possible fracture of the flask.



Spare caps can be found on page 253.

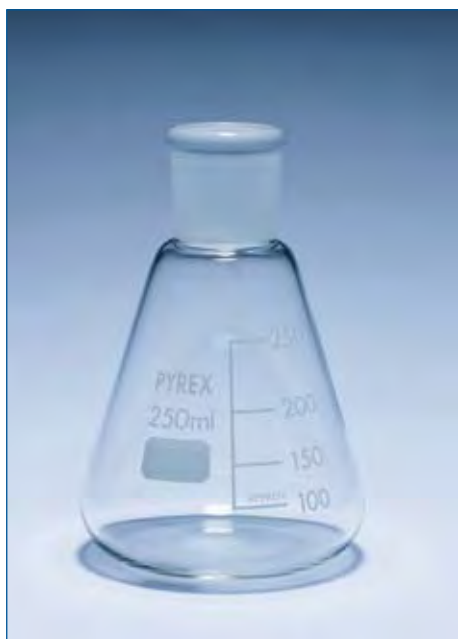

Flasks, conical, graduated with ground socket

PYREX®

- Erlenmeyer flasks with high quality Quickfit® ground glass socket
- Manufactured from Pyrex® borosilicate glass for highest resistance to thermal shock and chemical corrosion
- White enamel graduations and marking spot

Product Code	Capacity (ml)	Socket size	Approx overall height mm	Approx diam. mm	Pack qty.
1132/02	50	19/26	85	51	10
1132/06	100	19/26	109	64	10
1132/14	250	24/29	128	85	10
1132/20	500	29/32	167	105	10
1132/26	1000	29/32	208	131	10



These conical flasks are NOT suitable for use under vacuum.

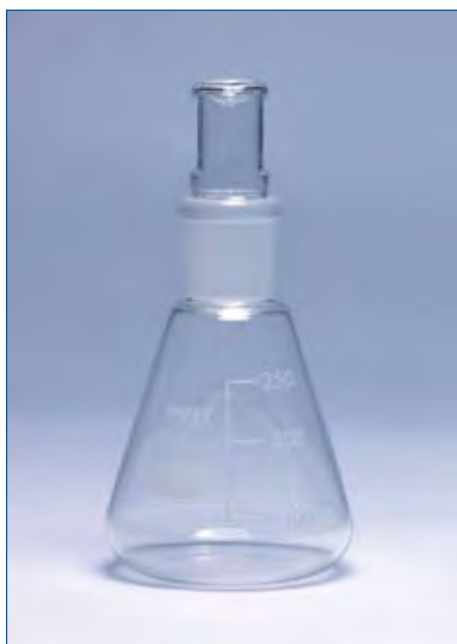

Flasks, conical, graduated, with stopper

PYREX®

- Erlenmeyer flasks with high quality Quickfit® ground glass socket
- Manufactured from Pyrex® borosilicate glass for highest resistance to thermal shock and chemical corrosion
- White enamel graduations and marking spot
- Supplied with hollow blown ground glass stopper

Product Code	Capacity (ml)	Socket size	Approx overall height mm	Approx diam. mm	Pack qty.
1133/02	50	19/26	85	51	10
1133/06	100	19/26	110	64	10
1133/14	250	24/29	130	85	10
1133/20	500	29/32	170	105	10
1133/26	1000	29/32	210	130	10



These flasks are NOT suitable for use under vacuum



Flasks, conical, with ground socket



- Complies to ISO 4797
- Conical flasks with highest quality Quickfit® ground glass socket
- Borosilicate glass for corrosion-free performance and high resistance to thermal shock

Product Code	Nom. capacity ml	Socket size	Approx overall height mm	Approx diam. mm	Pack qty.
FE5/1	5	14/23	54	25	5
FE10/1	10	14/23	60	34	5
FE25/0	25	10/19	64	40	5
FE25/1	25	14/23	70	42	5
FE25/2	25	19/26	70	42	5
FE50/1	50	14/23	85	51	5
FE50/2	50	19/26	85	51	5
FE50/3	50	24/29	90	51	5
FE100/1	100	14/23	100	64	5
FE100/2	100	19/26	100	64	5
FE100/3	100	24/29	100	64	5
FE100/4	100	29/32	100	64	5
FE150/2	150	19/26	118	74	5
FE150/3	150	24/29	118	74	5
FE150/4	150	29/32	116	74	5
FE250/2	250	19/26	130	85	5
FE250/3	250	24/29	130	85	5
FE250/4	250	29/32	130	85	5
FE250/5	250	34/35	130	85	5
FE500/2	500	19/26	175	101	5
FE500/3	500	24/29	175	101	5
FE500/4	500	29/32	175	101	5
FE500/5	500	34/35	175	101	5
FE1L/3	1000	24/29	220	130	2
FE1L/4	1000	29/32	220	130	2
FE1L/5	1000	34/35	220	130	2
FE2L/4	2000	29/32	270	160	1
FE2L/5	2000	34/35	270	160	1



For Quickfit® glass stoppers please see page 247.
Flasks FE5, FE25/0 and FE150 are supplementary to ISO standard.



Flasks, conical, vacuum



- With heavy walls and bases
- Suitable for use under vacuum

Product Code	Capacity (ml)	Socket size	Approx height (mm)	Approx diam. mm	Pack qty.
FEH250/3	250	24/29	139	90	1



Always take safety precautions when using flasks under vacuum.



Flask, conical, polypropylene



- Polypropylene erlenmeyer flask with excellent chemical resistance
- Wide neck with PP screw cap
- Flask and cap can be autoclaved at 121°C

Product Code	Capacity (ml)	Grads. ml	Thread size	Neck size	Pack qty.
FDE542	50	10	GL40	34/35	1
FDE544	100	20	GL40	34/35	1
FDE546	250	50	GL52	45/40	1
FDE548	500	100	GL52	45/40	1
FDE550	1000	200	GL52	45/40	1

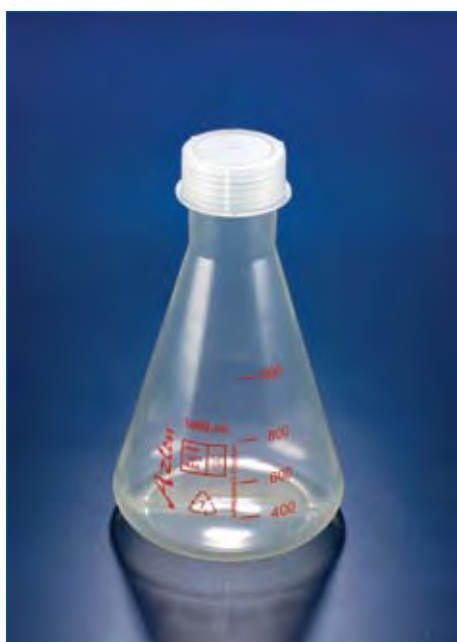

Flask, conical, PMP



- Manufactured from transparent PMP
- Wide neck with PP screw cap
- Flask and cap can be autoclaved at 121°C

Product Code	Capacity (ml)	Grads. ml	Thread size	Neck size	Pack qty.
FDE442	50	10	GL40	34/35	1
FDE444	100	20	GL40	34/35	1
FDE446	250	50	GL52	45/40	1
FDE448	500	100	GL52	45/40	1
FDE450	1000	200	GL52	45/40	1



Flasks, distillation, ASTM

PYREX®

- Complies with ASTM E133
- For the distillation of petroleum products
- Side arm inclined at 75° to the vertical axis
- For use with thermometers calibrated for 76mm immersion
- Length of side-arm is 100mm

Product Code	Capacity (ml)	Bulb diam. mm	Neck I.D. mm	Sidearm O.D. mm	Height mm	Pack qty.
1290/04M	125	69	17	7	214	5
1290/06M	250	86	15	6	215	5

i 125ml flask also complies with IP 123.



Flasks, distillation

PYREX®

- For general distillation work
- Side-arm is inclined at 75° to the vertical axis
- For use with thermometers calibrated for 76mm immersion
- Side-arm length is 140mm

Product Code	Capacity (ml)	Bulb diam. mm	Neck I.D. mm	Sidearm O.D. mm	Height mm	Pack qty.
1280/14M	500	105	24	10	240	5





Flasks, Büchner, plain side-arm

PYREX®

- Büchner type flasks for vacuum filtration
- Heavy walls provide increased mechanical strength
- 'Studded' base to minimise surface abrasion
- With integral glass side-arm to accept 9mm bore flexible tubing

Product Code	Nom. capacity ml	Body diam. mm	Neck I.D. mm	Height mm	Pack qty.
1170/02M	100	64	24	105	10
1170/04M	250	85	35	155	10
1170/06M	500	105	35	185	10
1170/08M	1000	135	45	230	5
1170/10D	2000	166	60	260	1
1170/12M	3000	187	68	335	5
1170/14D	5000	220	68	385	1

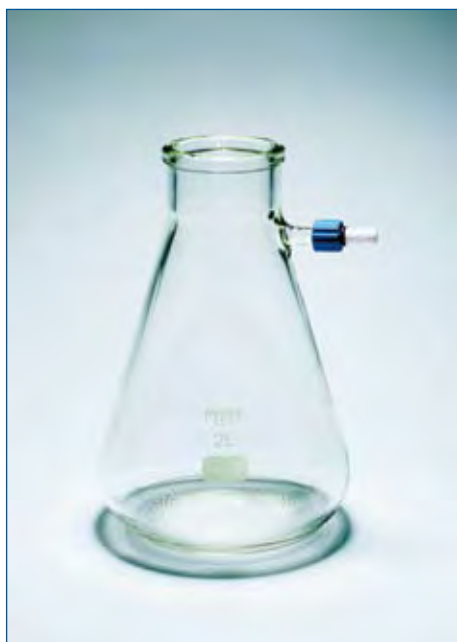

Flasks, Büchner, with screwthread connector

PYREX®

- Complies with ISO 6556
- Büchner flasks with heavy wall construction for vacuum filtration applications
- Side-arm features a PTFE screwthread connector for easy and safe fitting of 9mm bore vacuum tubing
- With tooled neck to accept a drilled rubber stopper

Product Code	Capacity (ml)	Body diam. mm	Neck I.D. mm	Height mm	Pack qty.
1170/02SC	100	64	24	105	10
1170/04SC	250	85	35	155	10
1170/06SC	500	105	35	185	10
1170/08SC	1000	135	45	230	5
1170/10SC	2000	166	60	260	1
1170/14SC	5000	220	68	385	1



5000ml size is supplementary to ISO range.
For spare PTFE screwthread connectors, please see page 96.



Flasks, Büchner, plain side-arm and ground socket



- Büchner filter flasks with precision-ground Quickfit® socket
- With traditional plain glass side-arm to accept 9mm bore vacuum tubing
- Heavy-wall and base construction for vacuum work

Product Code	Nom. capacity ml	Socket size	Approx height (mm)	Approx diam. mm	Pack qty.
FB100/2	100	19/26	107	64	2
FB100/3	100	24/29	107	64	2
FB250/3	250	24/29	145	85	2
FB250/4	250	29/32	145	85	2
FB500/3	500	24/29	172	105	2
FB500/4	500	29/32	172	105	2
FB1L/3	1000	24/29	227	136	2
FB1L/4	1000	29/32	227	136	2



Flasks, Büchner, with screwthread connector and ground socket



- Büchner flasks with precision-ground Quickfit® socket
- Side-arm features a PTFE screwthread connector for the safe attachment of 9mm bore vacuum tubing
 - Unscrew connector from flask and fit tubing:
 - Rescrew connector and tubing to flask
- Heavy walls and bases for vacuum filtration work

Product Code	Nom. capacity ml	Socket size	Approx height (mm)	Approx diam. mm	Pack qty.
FB100/2SC	100	19/26	107	64	2
FB100/3SC	100	24/29	107	64	2
FB250/3SC	250	24/29	145	85	2
FB250/4SC	250	29/32	145	85	2
FB500/3SC	500	24/29	172	105	2
FB500/4SC	500	29/32	172	105	2
FB1L/3SC	1000	24/29	227	136	2
FB1L/4SC	1000	29/32	227	136	2





Flasks, Iodine



- Complies with BS 2735
- For the determination of iodine
- Flask has ground socket and cup shaped top
- Stopper has extended handle which projects well above the liquid seal

Product Code	Nom. capacity ml	Joint size	Min. cup capacity ml	Pack qty.
FIB250/3	250	24/29	20	2
FIB250/4	250	29/32	20	2
FIB500/3	500	24/29	20	2
FIB500/4	500	29/32	20	2



FIB/4 items are supplementary to BS 2735.

Flasks, Iodine stopper

Product Code	Joint size	Pack qty.
SIB24	24/29	2
SIB29	29/32	2

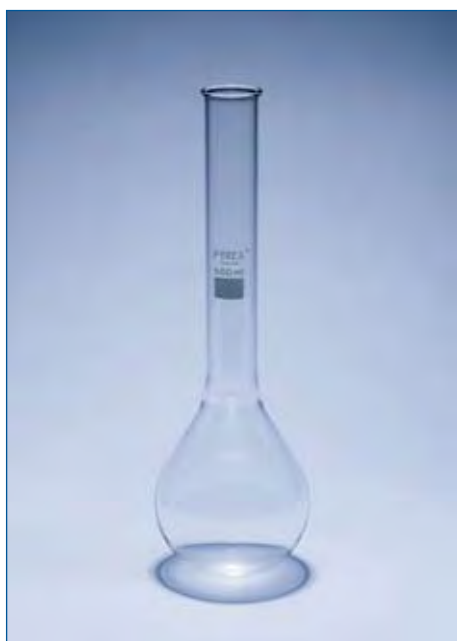

Flasks, Kjeldahl with plain neck

PYREX®

- Suitable for the determination of nitrogen etc.
- Manufactured from Pyrex® borosilicate glass
 - Withstands high temperatures
 - Resistant to chemical corrosion

Product Code	Capacity (ml)	Bulb diam. mm	Height mm	Neck O.D. mm	Neck I.D. mm	Pack qty.
1200/04M	100	58	240	22	17	10
1200/10D	300	81	300	28	24	10
1200/12D	500	101	325	34	30	10
1200/16M	800	115	350	34	30	10



The Kjeldahl method subjects flasks to severe chemical and thermal abuse. See care and maintenance of laboratory glassware for advice on safety and usage.



Flasks, Kjeldahl with ground socket



- For the determination of nitrogen by the Kjeldahl method
- Extra long necks act as air condensers during digestion stage and reduce entrainment during distillation stage

Product Code	Nom. capacity ml	Approx overall height mm	Socket size	Pack qty.
FK300/3L	300	295	24/29	1
FK500/3L	500	305	24/29	1
FK800/3L	800	325	24/29	1



A Quickfit® assembly for Kjeldahl digestions and distillations is described on page 205.



The Kjeldahl method of nitrogen determination imposes severe demands on glassware.

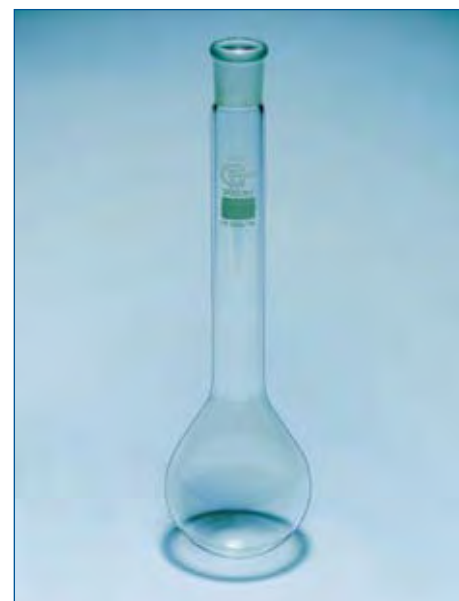

LIPSOL® LABWARE DETERGENT

- Excellent cleaning performance - ideal for use with laboratory glassware and plasticware
- Great value for money
- Totally biodegradable

For full details see page 89



CUSTOM GLASSWARE MANUFACTURE

- Free quotation without obligation
- Highest quality guaranteed
- All enquiries welcome

Tel: +44 (0)1785 812121
 Fax: +44 (0)1785 815066
 Email: customglass@scilabware.com





Flasks, flat bottom, short neck



- Complies with ISO 4797
- With highest quality Quickfit® ground glass socket
- Borosilicate glass for highest resistance to thermal shock and chemical corrosion
- Flat base allows use with hotplates

Product Code	Nom. capacity ml	Socket size	Approx overall height mm	Approx neck length mm	Pack qty.
FF50/2S	50	19/26	85	10	5
FF50/3S	50	24/29	85	10	5
FF100/2S	100	19/26	95	10	5
FF100/3S	100	24/29	103	15	5
FF100/4S	100	29/32	103	15	5
FF100/5S	100	34/35	103	15	5
FF150/2S	150	19/26	105	10	5
FF150/3S	150	24/29	110	15	5
FF150/4S	150	29/32	110	10	5
FF150/5S	150	34/35	115	10	5
FF250/2S	250	19/26	130	10	5
FF250/3S	250	24/29	130	10	5
FF250/4S	250	29/32	130	10	5
FF250/5S	250	34/35	130	10	5
FF500/2S	500	19/26	135	15	5
FF500/3S	500	24/29	140	15	5
FF500/4S	500	29/32	145	15	5
FF500/5S	500	34/35	155	20	5
FF1L/3US	1000	24/29	170	25	2
FF1L/4S	1000	29/32	187	20	2
FF1L/5S	1000	34/35	175	20	2
FF2L/3S	2000	24/29	205	25	1
FF2L/4S	2000	29/32	230	25	1
FF2L/5S	2000	34/35	215	20	1
FF4L/7S	4000	45/40	260	20	1



*These flat bottom flasks are NOT suitable for use under vacuum.
FF150/3S, FF150/4S, FF150/5S and FF500/2S are supplementary to ISO 4797.*



Flasks, flat bottom, medium neck



- With longer neck than standard Quickfit® flasks
- Useful in reducing the problems associated with splashing and frothing

Product Code	Capacity (ml)	Socket size	Approx overall height mm	Approx neck length mm	Pack qty.
FF100/3M	100	24/29	130	45	2
FF150/3M	150	24/29	140	45	2
FF250/3M	250	24/29	150	45	2
FF500/3UM	500	24/29	170	45	2
FF1L/3M	1000	24/29	190	45	2



These flat bottom flasks are NOT suitable for use under vacuum.



Flasks, Florentine



- Ideal for use with rotary evaporators
- Large surface area for rapid evaporation
- Robust heavy wall construction for added strength
- Shape allows easy removal of solid residues

Product Code	Nom. capacity ml	Socket size	Approx overall height mm	Pack qty.
FD50/4RE	50	29/32	94	2
FD100/3	100	24/29	108	1
FD100/4RE	100	29/32	107	1
FD250/3	250	24/29	148	1
FD250/4RE	250	29/32	151	1
FD500/3	500	24/29	165	1
FD500/4RE	500	29/32	160	1
FD1L/3	1000	24/29	204	1
FD1L/4RE	1000	29/32	198	1
FD2L/4RE	2000	29/32	245	1



Most Rotary Evaporators accept flasks with size 29/32 ground glass sockets - check first.





Flasks, pear shaped, single neck



- With highest quality Quickfit® ground glass socket
- Ideal for semi-micro distillations
- Pear shaped design allows distillation down to small bulk:
 - Minimum hold-up
 - Reduced losses from thermal decomposition
- Borosilicate glass for chemical resistance and thermal performance

Product Code	Capacity (ml)	Socket size	Approx overall height mm	Approx diam. mm	Pack qty.
FP5/1	5	14/23	67	23	1
FP10/1	10	14/23	85	28	1
FP25/0	25	10/19	89	38	1
FP25/1	25	14/23	100	38	1
FP50/1	50	14/23	115	48	1
FP50/2	50	19/26	125	48	1
FP100/1	100	14/23	135	58	1
FP100/2	100	19/26	140	58	1
FP100/3	100	24/29	150	58	1



For advice on the use of glassware under conditions of temperature and vacuum, please refer to the care and maintenance section.



Flask, pear shaped, two necks



- With one vertical centre neck and one angled side neck

Product Code	Capacity (ml)	Centre socket	Side socket	Approx overall height mm	Pack qty.
FP50/1/1A	50	14/23	14/23	115	1



The axis of the side neck meets the axis of the central neck at the bottom of the flask.



Flasks, pear shaped, three necks



- With vertical centre neck
- One vertical side neck and one angled side neck

Product Code	Nom. capacity ml	Centre socket	Side socket	Approx overall height mm	Pack qty.
FP25/0AP	25	10/19	10/19	112	1



Flasks, pear shaped, distillation



- Designed for micro and semi-micro distillations
- Vertical neck with Quickfit® socket for introducing a thermometer etc.
- Angled Quickfit® cone for connecting to condenser

Product Code	Capacity (ml)	Socket size	Cone size	Approx overall height mm	Pack qty.
MD2/50	50	14/23	14/23	147	1



Flasks, pear shaped, Claisen-Vigreux



- Incorporates a short, Vigreux type fractionating column
- Column indents aid intimate contact between vapour and liquid

Product Code	Capacity (ml)	Socket size	Cone size	Pack qty.
MD4/50	50	14/23	14/23	1
MD4/100	100	14/23	14/23	1

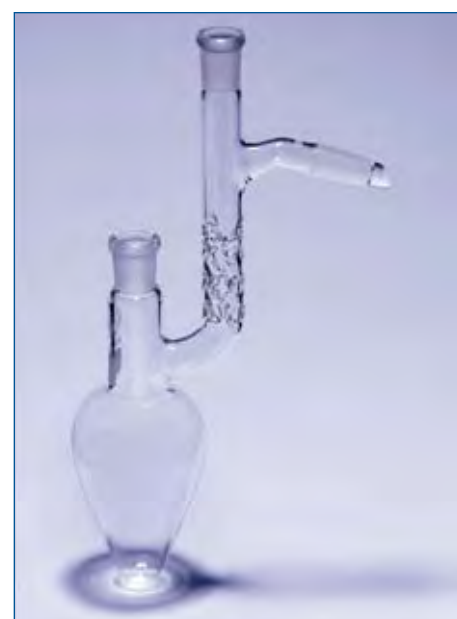



Flasks, round bottom, short neck



- With highest quality Quickfit® ground glass socket
- Manufactured from borosilicate glass for corrosion-free performance and resistance to thermal shock
- Comprehensive range of 46 flasks from 5ml to 10000ml
- Body diameter and wall thickness comply with relevant ISO 1773 and ISO 4797 requirements

Product Code	Capacity (ml)	Socket size	Approx overall height mm	Approx neck length mm	Pack qty.
FR5/0S*	5	10/19	50	5	5
FR5/1S*	5	14/23	65	15	5
FR10/0S*	10	10/19	65	15	5
FR10/1S	10	14/23	70	15	5
FR25/1S	25	14/23	85	10	5
FR25/2S*	25	19/26	80	15	5
FR25/3S*	25	24/29	80	15	5
FR50/1S	50	14/23	90	15	5
FR50/2S	50	19/26	90	15	5
FR50/3S	50	24/29	90	15	5
FR50/5S	50	34/35	90	15	5
FR100/1S	100	14/23	105	15	5
FR100/2S	100	19/26	105	15	5
FR100/3S	100	24/29	105	15	5
FR100/4S	100	29/32	105	15	5
FR100/5S	100	34/35	105	10	5
FR150/2S*	150	19/26	114	10	5
FR150/3S*	150	24/29	115	15	5
FR150/4S*	150	29/32	120	15	5
FR150/5S*	150	34/35	118	10	5
FR250/1S*	250	14/23	126	15	2
FR250/2S	250	19/26	140	15	5
FR250/3S	250	24/29	140	15	5
FR250/4S	250	29/32	140	15	5
FR250/5S	250	34/35	140	15	5



Flasks, round bottom, short neck (continued)

Product Code	Capacity (ml)	Socket size	Approx overall height mm	Approx neck length mm	Pack qty.
FR500/2S	500	19/26	147	15	5
FR500/3S	500	24/29	163	15	5
FR500/4S	500	29/32	163	15	5
FR500/5S	500	34/35	163	25	5
FR1L/2S	1000	19/26	177	15	2
FR1L/3S	1000	24/29	180	15	2
FR1L/4S	1000	29/32	183	10	2
FR1L/5S	1000	34/35	196	20	2
FR1L/7S	1000	45/40	201	25	1
FR2L/3US	2000	24/29	205	10	1
FR2L/3S	2000	24/29	240	20	1
FR2L/4S	2000	29/32	240	15	1
FR2L/5S	2000	34/35	228	20	1
FR3L/3S*	3000	24/29	236	15	1
FR3L/5S*	3000	34/35	249	20	1
FR4L/7S	4000	45/40	290	20	1
FR5L/4S	5000	29/32	270	15	1
FR5L/5US	5000	34/35	280	20	1
FR5L/8S*	5000	50/42	289	20	1
FR6L/7S	6000	45/40	300	20	1
FR10L/5S	10000	34/35	350	20	1

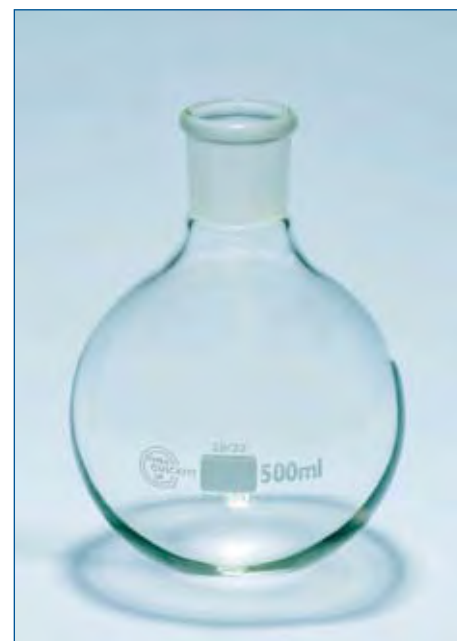

 * supplementary to the ISO 4797 range.

Flask stand, polypropylene



- Suitable for most round bottomed flasks
- Has stepped concentric rings to help stabilise flask
- Autoclavable up to 121°C
- Has good chemical resistance

Product Code	Top I.D. mm	Pack qty.
TWR038	145	1





Flasks, round bottom, medium neck



- With a longer neck than standard Quickfit® flasks
- Useful for reducing problems associated with frothing and splashing

Product Code	Nom. capacity ml	Socket size	Approx overall height mm	Approx neck length mm	Pack qty.
FR50/3M	50	24/29	130	45	5
FR100/3M	100	24/29	145	45	2
FR150/3M	150	24/29	150	45	2
FR250/3M	250	24/29	165	45	2
FR500/3M	500	24/29	180	45	2
FR500/3U	500	24/29	205	70	1
FR1L/3UM	1000	24/29	205	40	2



Flasks, round bottom, two necks



- Fitted with two Quickfit® ground glass sockets
 - One vertical centre neck
 - One angled side neck
- Side neck useful for introducing gas inlet tubes and thermometers etc into the flask
- Manufactured from borosilicate glass for highest resistance to thermal shock and chemical attack

Product Code	Capacity (ml)	Centre socket	Side socket	Approx overall height mm	Pack qty.
FR25/1S/1A	25	14/23	14/23	77	1
FR50/1S/1A	50	14/23	14/23	89	1
FR100/3S/1A	100	24/29	14/23	110	1
FR100/3S/2A	100	24/29	19/26	110	1
FR250/3S/1A	250	24/29	14/23	130	1
FR250/3S/2A	250	24/29	19/26	130	1
FR500/3S/1A	500	24/29	14/23	150	1
FR500/3S/2A	500	24/29	19/26	150	1
FR1L/3S/1A	1000	24/29	14/23	180	1
FR1L/3S/2A	1000	24/29	19/26	180	1
FR2L/5S/2A	2000	34/35	19/26	225	1



The axis of the side neck meets the axis of the centre neck at the bottom of the flask.



Flasks, small capacity, with septum side neck



- Designed for semi-micro and micro scale preparations
- One vertical centre neck having precision-ground Quickfit® socket to accept Quickfit® cone
- One angled side neck designed to take a rubber septum seal to allow small quantities of liquid to be handled easily and safely using a syringe

Product Code	Capacity (ml)	Centre socket	Side socket	Approx overall height mm	Pack qty.
FR10/1S/SEP	10	14/23	Septum	60	1
FR25/1S/SEP	25	14/23	Septum	77	1

i Septum side necks have an O.D. of 19mm and an I.D. of 15.4mm to accept a 16mm septum.



Flasks, round bottom, three necks



- Fitted with three Quickfit® precision-ground sockets
 - One vertical centre neck
 - Two angled side necks
- Quickfit® ground glass sockets are manufactured to an accuracy which surpasses the requirements of ISO 383

Product Code	Nom. capacity ml	Centre socket	Side sockets	Approx overall height mm	Pack qty.
FR25/1S/11A	25	14/23	14/23	77	1
FR25/2S/11A	25	19/26	14/23	80	1
FR50/1S/11A	50	14/23	14/23	89	1
FR50/2S/11A	50	19/26	14/23	92	1
FR50/2S/22A	50	19/26	19/26	92	1
FR100/2S/11A	100	19/26	14/23	108	1
FR100/3S/11A	100	24/29	14/23	110	1
FR100/3S/22A	100	24/29	19/26	110	1
FR250/2S/22A	250	19/26	19/26	128	1
FR250/3S/11A	250	24/29	14/23	130	1
FR250/3S/22A	250	24/29	19/26	130	1
FR250/4S/11A	250	29/32	14/23	135	1
FR250/4S/22A	250	29/32	19/26	135	1
FR500/3S/11A	500	24/29	14/23	150	1
FR500/3S/22A	500	24/29	19/26	150	1
FR500/4S/22A	500	29/32	19/26	153	1
FR1L/3S/22A	1000	24/29	19/26	180	1
FR1L/4S/22A	1000	29/32	19/26	183	1
FR1L/4S/44A	1000	29/32	29/32	183	1
FR1L/5S/22A	1000	34/35	19/26	195	1
FR2L/3US/22A	2000	24/29	19/26	205	1
FR2L/5S/22A	2000	34/35	19/26	228	1
FR3L/5S/22A	3000	34/35	19/26	249	1



i The axes of the side necks meet the axis of the central neck at the bottom of the flask.

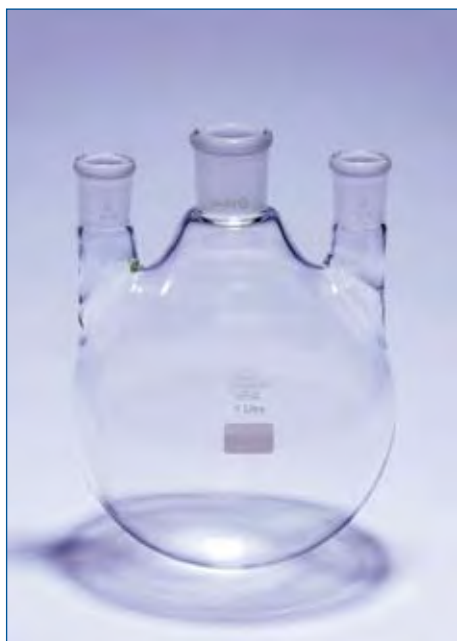

Flasks, round bottom, three vertical necks



- With one vertical centre neck and two vertical side necks

Product Code	Capacity (ml)	Centre socket	Side sockets	Approx overall height mm	Pack qty.
FR250/3S/22P	250	24/29	19/26	130	1
FR250/4S/11P	250	29/32	14/23	135	1
FR500/3S/22P	500	24/29	19/26	150	1
FR500/4S/22P	500	29/32	19/26	153	1
FR1L/3S/22P	1000	24/29	19/26	180	1
FR1L/4S/22P	1000	29/32	19/26	185	1
FR1L/5S/22P	1000	34/35	19/26	195	1
FR1L/5S/33P	1000	34/35	24/29	195	1
FR2L/3US/22P	2000	24/29	19/26	210	1
FR2L/4S/22P	2000	29/32	19/26	220	1
FR2L/4S/44P	2000	29/32	29/32	218	1
FR2L/5S/22P	2000	34/35	19/26	228	1
FR2L/5S/33P	2000	34/35	24/29	228	1
FR2L/7S/44P	2000	45/40	29/32	233	1
FR3L/5S/22P	3000	34/35	19/26	249	1
FR3L/5S/33P	3000	34/35	24/29	249	1
FR4L/7S/44P	4000	45/40	29/32	270	1
FR5L/5US/33P	5000	34/35	24/29	275	1
FR6L/7S/44P	6000	45/40	29/32	300	1



Flasks, Roux culture, off-set neck

PYREX®

- Ideal for cell culture
- Manufactured from chemically inert Pyrex® glass for a contamination-free environment
- Withstands repeated autoclaving
- Off-set neck

Product Code	Capacity (ml)	Base x height mm	Neck I.D. mm	Length (mm)	Pack qty.
1350/04M	600	107 x 47	28	230	10
1350/06M	1200	123 x 56	33	275	10



Flasks, reaction, wide neck, flat flange



- With large diameter Quickfit® flat-flange joint
- For use with Quickfit® flat-flange lids and retaining clips
- Wide neck allows easy incorporation of stirrer paddles and easy removal of solid residues

Product Code	Item code: clip to fit	Nom. capacity ml	Flange bore mm	Flask shape	Approx overall height mm	Pack qty.
FR250F	JC75F	250	75	Spherical	90	1
FR500F	JC75F	500	75	Spherical	115	1
FR700F	JC100F	700	100	Cylindrical	135	1
FR1LF	JC100F	1000	100	Spherical	155	1
FR2LF	JC100F	2000	100	Spherical	185	1
FR3LF	JC100F	3000	100	Spherical	210	1
FR4LF	JC100F	4000	100	Spherical	225	1
FR5LF	JC100F	5000	100	Spherical	245	1
FR6LF	JC100F	6000	100	Spherical	260	1
FR10LF	JC100F	10000	100	Spherical	320	1
FR20LF	JC100F	20000	100	Spherical	380	1



The cylindrical shaped 700ml flask fits a 500ml heating mantle.
See pages 152 for a comprehensive range of flat flange lids and retaining clips.

Flasks, reaction, jacketed



- With outer jacket for circulation of water or oil etc
- Ideal for temperature controlled reactions
- For use with Quickfit® flat-flange lids and retaining clips

Product Code	Nom. capacity ml	Flange bore mm	Overall height mm	External diam. mm	Sidearm O.D. mm	Pack qty.
JRV1L	1000	100	228	140.0	12	1
JRV2L	2000	100	312	165.0	12	1



When circulating hot water or oil through the jacket, take care to avoid thermal shock.
Raise the temperature gradually and do not exceed 300°C.





Culture vessels



- Ideal for fermentation and culture work
- Manufactured from temperature resistant borosilicate glass
- Autoclavable
- With precision-ground flat-flange joint
- For use with Quickfit® flat-flange lids and retaining clips

Product Code	Capacity (ml)	Flange bore mm	Approx overall height mm	Approx diam. of body (mm)	Pack qty.
FV500	500	75	130	80	1
FV1L	1000	100	160	105	1
FV2L	2000	100	225	133	1
FV5L	5000	100	290	181	1
FV10L	10000	100	375	227	1
FV20L	20000	100	465	288	1



Culture vessels with flat bases are not suitable for use under vacuum.



Lids for wide neck flasks



- With precision ground flat-flange joints
- Fits Quickfit® wide neck reaction flasks and culture vessels
- Each lid with one or more sockets to accept other Quickfit® components

Product Code	Flange bore mm	Vertical centre socket	Side socket (0°)	Side socket (5°)	Side socket (10°)	Side socket (15°)	Pack qty.
MAF1/75	75	19/26	14/23	19/26	19/26	19/26	1
DA5/75	75	34/35	-	-	-	-	1
MAF2/2	100	19/26	19/26	2 x 19/26	19/26	-	1
MAF2/32	100	19/26	19/26	24/29	19/26	-	1
MAF2/41	100	19/26	14/23	14/23	14/23	29/32	1
MAF2/52	100	19/26	19/26	19/26	19/26	34/35	1
MAF3/52	100	24/29	19/26	19/26	19/26	34/35	1
DA4/100	100	29/32	-	-	-	-	1
MAF4/41	100	29/32	14/23	14/23	14/23	29/32	1
DA5/100	100	34/35	-	-	-	-	1
MAF5/2	100	34/35	19/26	-	2 x 19/26	-	1

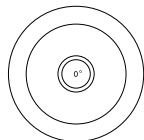

DA4/100
DA5/75
DA5/100

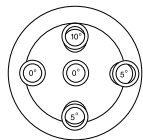

MAF2/2

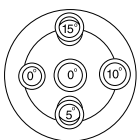

MAF1/75

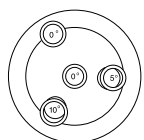

MAF2/32

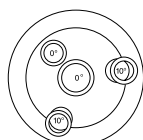

MAF5/2

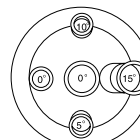

MAF2/41
MAF2/52
MA3/25
MAF4/41



Lids should be secured to flasks with relevant metal clips, JC75F or JC100F as detailed overleaf.



Retaining clips for wide neck flask lids



- For securing flat flange lids to wide neck reaction flasks and culture vessels
- Stainless steel construction

Product Code	Flange bore mm	Pack qty.
JC75F	75	1
JC100F	100	1



PTFE Seals



- For use with Quickfit® flat flange jointed glassware
- Manufactured from PTFE for excellent chemical resistance
- Forms tight seal with flat flange joints

Product Code	Flange bore mm	Thickness (mm)	Pack qty.
PS75	75	0.5	1
PS100	100	0.5	1



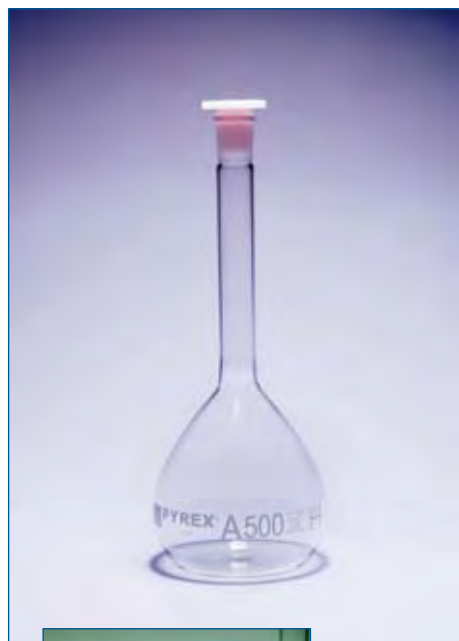

Flasks, volumetric, class A, works certified, DIN/ISO/USP tolerances

PYREX®

- Complies with ISO 1042 and DIN 12664
- Calibrated to the tolerances required by the United States Pharmacopoeia (USP) which are tighter than those of ISO/DIN standards
- Each flask engraved with individual serial number and supplied with certificate of calibration traceable to National standards
- Conformity 'H' certified
- Manufactured from borosilicate glass for corrosion-free performance
- White enamel inscriptions
- Polyethylene stopper

Product Code	Capacity (ml)	Tol. +/- ml	Approx height (mm)	Stopper size	Pack qty.
3151/01WC	1	0.020	65	7/16	5
3151/02WC	2	0.020	65	7/16	5
3151/04WC	5	0.020	70	10/19	5
3151/06WC	10	0.020	90	10/19	5
3151/08WC	20	0.03	110	10/19	5
3151/10WC	25	0.03	110	10/19	5
3151/12WC	50	0.05	140	12/21	5
3151/14WC	100	0.08	170	14/23	5
3151/16WC	200	0.10	210	14/23	5
3151/18WC	250	0.12	220	14/23	2
3151/20WC	500	0.20	260	19/26	2
3151/22WC	1000	0.30	300	24/29	2
3151/24WC	2000	0.50	370	29/32	1
3151/26WC	5000	1.00	574	34/35	1

i 20ml and 5000ml sizes are supplementary to DIN range.



Flasks, volumetric, class A, amber, works certified, DIN/ISO/USP tolerances

PYREX®

- Complies with ISO 1042 and DIN 12664
- Calibrated to the tolerances required by the United States Pharmacopoeia (USP) which are tighter than those of ISO/DIN standards
- Each flask engraved with individual serial number and supplied with certificate of calibration traceable to National standards
- Manufactured from borosilicate glass with an amber coating on exterior surfaces to facilitate use with light sensitive solutions
- Conformity 'H' certified
- Polyethylene stopper
- White enamel inscriptions

Product Code	Capacity (ml)	Tol. +/- ml	Approx height (mm)	Stopper size	Pack qty.
3152/04AWC	5	0.020	70	10/19	5
3152/06AWC	10	0.020	90	10/19	5
3152/08AWC	25	0.03	110	10/19	5
3152/10AWC	50	0.05	140	12/21	5
3152/12AWC	100	0.08	170	14/23	5
3152/14AWC	200	0.10	210	14/23	5
3152/16AWC	250	0.12	220	14/23	2
3152/18AWC	500	0.20	260	19/26	2
3152/20AWC	1000	0.30	300	24/29	2
3152/22AWC	2000	0.50	370	29/32	1

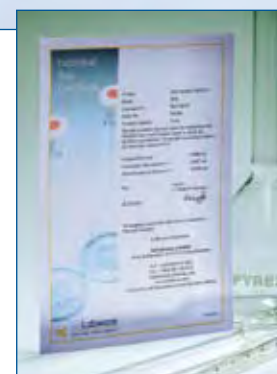

i For spare polyethylene stoppers, please see page 249.

AZLON® SQUAT FORM MEASURING CYLINDERS

- Low height improves stability on lab bench
- Easier to manoeuvre in fume cupboards
- Robust polypropylene construction
- Unique drainage hole for problem-free washing

For full details see CPS: range on page 109





Flasks, volumetric, class A, ISO/DIN/USP tolerances

PYREX®

- Complies with ISO 1042 and DIN 12664
- Calibrated to the tolerance required by the United States Pharmacopoeia (USP) which is tighter than those of ISO/DIN standards
- Each flask is laser etched with an individual serial number batch code and date of manufacture
- Batch certificate available to download online
- Conformity 'H', certified
- Manufactured from chemically resistant Pyrex® glass
- Inscriptions in white enamel
- Polyethylene stopper

Product Code	Capacity (ml)	Tol. ± ml	Approx height (mm)	Stopper size	Pack qty.
3151/01	1	0.02	65	7/16	5
3151/02	2	0.02	65	7/16	5
3151/04	5	0.02	70	10/19	5
3151/06	10	0.02	90	10/19	5
3151/08	20	0.03	110	10/19	5
3151/10	25	0.03	110	10/19	5
3151/12	50	0.05	140	12/21	5
3151/14	100	0.08	170	14/23	5
3151/16	200	0.10	210	14/23	5
3151/18	250	0.12	220	14/23	2
3151/20	500	0.20	260	19/26	2
3151/22	1000	0.30	300	24/29	2
3151/24	2000	0.50	370	29/32	1
3151/26	5000	1.00	475	34/35	1



20ml and 5000ml sizes are supplementary to DIN range.

Please note that the downloadable batch certificates can be obtained by visiting www.scilabware.com and entering the unique batch code, which can be found on the base of each flask.



Flasks, volumetric, class A, amber, DIN/ISO/USP tolerances

PYREX®

- Complies with ISO 1042 and DIN 12664
- Calibrated to the tolerance required by the United States Pharmacopoeia (USP) which are tighter than those of ISO/DIN standards
- Manufactured from borosilicate glass with an amber coating on exterior surfaces to facilitate use with light sensitive solutions
- Each flask is laser etched with an individual serial number batch code and date of manufacture
- Conformity 'H' certified
- Batch certificate available to download online

Product Code	Capacity (ml)	Tol. ± ml	Approx height (mm)	Stopper size	Pack qty.
3152/04A	5	0.02	70	10/19	5
3152/06A	10	0.02	90	10/19	5
3152/08A	25	0.03	110	10/19	5
3152/10A	50	0.05	140	12/21	5
3152/12A	100	0.08	170	14/23	5
3152/14A	200	0.10	210	14/23	5
3152/16A	250	0.12	220	14/23	2
3152/18A	500	0.20	260	19/16	2
3152/20A	1000	0.30	300	24/29	2
3152/22A	2000	0.50	370	29/32	1

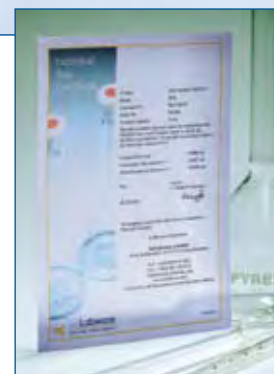

LIPSOL® LABWARE DETERGENT

- Excellent cleaning performance - ideal for use with laboratory glassware and plasticware
- Great value for money
- Totally biodegradable

For full details see page 89





Flasks, volumetric, class A

MBL®

- Complies with ISO 1042 and DIN 12664
- Finely calibrated to Class A tolerances
- Each flask is laser etched with an individual serial number, batch code and date of manufacture
- Manufactured from chemically resistant borosilicate glass
- Conformity 'H' certified
- Inscriptions in blue enamel
- Supplied with polyethylene stopper
- Batch certificate available to download online

Product Code	Capacity (ml)	Tol. +/- ml	Approx height (mm)	Stopper size	Pack qty.
FRD164	5	0.025	70	10/19	5
FRD166	10	0.025	90	10/19	5
FRD167	20	0.04	110	10/19	5
FRD168	25	0.06	110	10/19	5
FRD170	50	0.06	140	12/21	5
FRD172	100	0.10	170	14/23	5
FRD174	200	0.15	210	14/23	5
FRD176	250	0.15	220	14/23	2
FRD178	500	0.25	260	19/26	2
FRD180	1000	0.40	300	24/29	2
FRD182	2000	0.60	370	29/32	1
FRD184	5000	1.20	475	34/35	1



The downloadable batch certificates can be obtained by visiting www.scilabware.com and entering the unique batch code, which can be found on the base of each flask.



Flasks, volumetric, class B

MBL®

- Complies with ISO 1042 and DIN 12664
- Manufactured from borosilicate glass for corrosion-free performance
- Inscriptions in blue enamel
- Polyethylene stopper

Product Code	Capacity (ml)	Tol. +/- ml	Approx height (mm)	Stopper size	Pack qty.
FRD022P	5	0.05	70	10/19	5
FRD024P	10	0.05	90	10/19	5
FRD025P	20	0.08	110	10/19	5
FRD026P	25	0.08	110	10/19	5
FRD028P	50	0.12	140	12/21	5
FRD030P	100	0.20	170	14/23	5
FRD032P	200	0.30	210	14/23	5
FRD034P	250	0.30	220	14/23	2
FRD036P	500	0.50	260	19/26	2
FRD038P	1000	0.80	300	24/29	2
FRD040P	2000	1.20	370	29/32	1
FRD042P	5000	2.40	475	34/35	1



CUSTOM GLASSWARE MANUFACTURE

- Free quotation without obligation
- Highest quality guaranteed
- All enquiries welcome

Tel: +44 (0)1785 812121
 Fax: +44 (0)1785 815066
 Email: customglass@scilabware.com



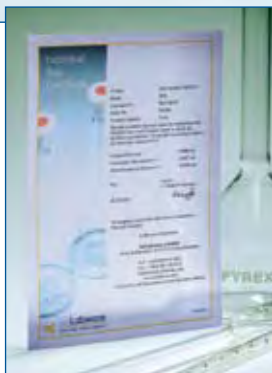

Flasks, volumetric, Col Lisse, class A

MBL®

- Complies with ISO 1042
- With plain neck to accept rubber stopper
- Manufactured from borosilicate glass
- Finely calibrated to Class A tolerances
- Conformity 'H' certified
- Individually laser etched with serial number, batch code and date of manufacture
- Batch certificate available to download online
- Blue enamel inscriptions

Product Code	Capacity (ml)	Tol. +/- ml	Approx height (mm)	Neck I.D. mm	Pack qty.
FRD200	5	0.025	70	7	5
FRD202	10	0.025	90	7	5
FRD204	20	0.04	110	9	5
FRD206	25	0.04	110	9	5
FRD208	50	0.06	140	11	5
FRD210	100	0.10	170	13	5
FRD212	200	0.15	210	15	5
FRD214	250	0.15	220	16	2
FRD216	500	0.25	260	19	2
FRD218	1000	0.40	300	23	2
FRD220	2000	0.60	370	27	1
FRD222	5000	1.20	475	42	1

 Rubber stoppers not supplied.





Flasks, volumetric, class A, PMP (TPX)

A  *Aston*

- Manufactured from glass-clear PMP offering excellent clarity
- Individually adjusted ring-mark to class A tolerances according to ISO 1042
- Complete with printed batch code
- Batch certificate available to download online
- Supplied with polypropylene stopper

Product Code	Capacity (ml)	Tol. ± ml	Height with stopper mm	Neck size	Pack qty.
PDF112A	25	0.04	115	10/19	1
PDF118A	50	0.06	150	12/21	1
PDF124A	100	0.10	180	14/23	1
PDF130A	250	0.15	235	19/26	1
PDF136A	500	0.25	270	19/26	1
PDF138A	1000	0.40	310	24/29	1

 Downloadable batch certificates are available from www.scilabware.com

 Cleaning up to max. 60°C is recommended to preserve marks and inscriptions.



Flasks, volumetric, class B, PMP (TPX)



- Manufactured from transparent PMP offering excellent clarity
- Clear easy to read calibration line
- Calibrated to ISO 1042, class B tolerances
- Supplied with polypropylene stopper

Product Code	Capacity (ml)	Tol. \pm ml	Height with stopper mm	Neck size	Pack qty.
FDF112N	25	0.08	115	10/19	1
FDF118N	50	0.12	150	10/19	1
FDF124N	100	0.20	180	14/23	1
FDF130N	250	0.30	235	19/26	1
FDF136N	500	0.50	270	19/26	1
FDF138N	1000	0.80	310	24/29	1



Exposure to temperatures up to 121°C (autoclaving) will not cause permanent exceeding of tolerance limits



Cleaning up to max. 60°C is recommended to preserve marks and inscriptions.

Flasks, volumetric, class B, polypropylene



- Manufactured from translucent polypropylene giving good durability
- Clear easy to read calibration line
- Calibrated to ISO 1042, class B tolerances
- Supplied with polypropylene stopper

Product Code	Capacity (ml)	Tol. \pm ml	Height with stopper mm	Neck size	Pack qty.
FDF012N	25	0.08	115	10/19	1
FDF018N	50	0.12	150	10/19	1
FDF024N	100	0.20	180	14/23	1
FDF030N	250	0.30	235	19/26	1
FDF036N	500	0.50	270	19/26	1
FDF038N	1000	0.80	310	24/29	1



Exposure to temperatures above 60°C may affect accuracy and remove marks and inscriptions.



Flasks, Kohlrusch, class A

MBL®

- Complies with BS 615
- With expanded neck for easy introduction of viscous liquids or solid samples
- 2 sizes available:
 - 100ml for sugar analysis
 - 200ml for determination of oil viscosity by Engler method
- Calibrated to Class A tolerances
- White enamel inscriptions
- Manufactured from soda-lime glass

Product Code	Capacity (ml)	Tol. ± ml	Approx height (mm)	Pack qty.
FRE011	100	0.06	155	2
FRE013	200	0.10	185	2





Flow indicator, PMP (TPX)



- Simple but highly effective device to show flow of liquid or gas
- Transparent robust moulding with a coloured paddle wheel
- Operates at low flow rates (the impeller starts to turn at 150ml/min)
- Stepped side arms are tapered to accept tubing from 6 - 11mm I.D.

Product Code	Overall length mm	Volume ml	Pack qty.
FWY053	90	10	1

 2 bar operating pressure. +60°C operating temperature.

 Not suitable for use with strong acids / alkalis or solvents.



Fractionating columns, plain



- Borosilicate glass with Quickfit® ground-glass joints for dependable performance
- Designed for use with various types of column packing e.g. Raschig rings or Fenske helices

Product Code	Approx surface area x	Socket size	Cone size	Approx effective length	Approx overall length mm	Pack qty.
FC7/23	2.0	24/29	24/29	250	365	1
FC7/43	4.0	24/29	24/29	500	615	1



The Quickfit® range of C2: air condensers listed on page 90 can also be used as fractionating columns.



Column packing support



- Designed to support Raschig rings within plain fractionating columns
- Support is passed through socket of column and rests at the constriction above the cone
- Manufactured from chemically resistant borosilicate glass

Product Code	Fits socket size	Diam. mm	Pack qty.
EX13/12	19/26	16	1
EX13/23	24/29	21	1
EX13/25	34/35	29	1
EX13/26	40/38	35	1



Column packing, Raschig rings



- For use with Quickfit® plain fractionating columns
- Raschig rings - short lengths of glass tubing
- Supplied in 1 litre bags
- Manufactured from borosilicate glass for contamination-free performance

Product Code	Description	Approx diam. mm	Approx length mm	Pack qty.
FC8/06	Raschig rings	6	6	1
FC8/09	Raschig rings	9	9	1



To support the packing within the column, the use of packing supports EX13: series is recommended.





Fractionating columns, Vigreux



- Popular, easy to use column
- Vigreux type with combination of horizontal and angled indentations
- Horizontal indentations ensure intimate vapour and liquid contact
- Angled indentations redistribute liquid from walls to centre of column

Product Code	Socket size	Cone size	Approx effective length (mm)	Sets of points	Pack qty.
FC3/13	24/29	24/29	360	7	1
FC3/23	24/29	24/29	600	12	1
FC3/14	29/32	29/32	360	7	1



Fractionating columns, Dufton



- Comprises of a column with accurately fitted Dufton glass spiral
- Good efficiency - liquid spiralling down column meets ascending vapour
- Spiral can be removed for cleaning

Product Code	Socket size	Cone size	Approx effective length (mm)	Approx overall height mm	Pack qty.
FC1/12	19/26	19/26	150	270	1
FC1/22	19/26	19/26	300	425	1
FC2/13	24/29	24/29	150	290	1
FC2/23	24/29	24/29	300	435	1





Distillation head



- Fits on the top of a fractionating column to provide an effective liquid dividing head
- With integral jacketed condenser
- Liquid leaving condenser is directed towards a GP Rotaflo® stopcock
- Adjustment of stopcock controls proportion of liquid returned to the column or collected
- Screwcap fitting for insertion of thermometer
- Side-arm for venting or connection to vacuum supply

Product Code	Cone size to fit column	Cone size to fit receiver	Screwthread size mm	Stopcock bore mm	Condenser surface area x 10 ² m	Pack qty.
SH30/42/SC	29/32	19/26	13	3.0	4.0	1



Funnels, short stem

PYREX®

- With 60° bowl angle for precise fitting of filter paper
- Manufactured from chemical and heat resistant Pyrex® borosilicate glass

Product Code	Top external diam. mm	Stem O.D. mm	Stem length mm	Overall height mm	To suit filter paper diam. mm	Pack qty.
2140/01M	35	8	35	60	45-55	10
2140/02M	45	8	45	78	55-70	10
2140/03M	70	8	75	125	70-90	10
2140/06M	80	8	82	144	90-150	10
2140/10M	105	10	106	186	150-185	10
2140/11M	125	12	122	220	185-240	1
2140/12M	150	16	154	270	240-270	1
2140/14M	200	24	193	345	320-385	1





Funnels, long stem

PYREX®

- With 60° bowl angle for precise fitting of filter paper
- Manufactured from chemical and heat resistant Pyrex® borosilicate glass
- Stem approximately 150mm

Product Code	Top external diam. mm	Stem O.D. mm	Overall height mm	To suit filter paper diam. mm	Pack qty.
2145/03M	70	8	205	70-90	10
2145/06M	80	8	215	90-150	10
2145/10M	105	8	237	150-185	10

CUSTOM GLASSWARE MANUFACTURE

- Free quotation without obligation
- Highest quality guaranteed
- All enquiries welcome

Tel: +44 (0)1785 812121
Fax: +44 (0)1785 815066
Email: customglass@scilabware.com





Funnels, lightweight, polypropylene



- Lightweight polypropylene funnels with ribs that prevent air locks, allowing rapid filtration
- Autoclavable to 121°C
- Made from food grade plastic

Product Code	Top I.D. mm	Stem O.D. at tip mm	Overall height mm	Pack qty.
FWC052	30	2	47	10
FWC054	30	5	47	10
FWC056	40	5	62	10
FWC058	50	9	78	10
FWC060	75	10	107	10
FWC062	100	13	149	10
FWC064	120	14	170	5
FWC066	150	17	210	5



i For information on food safety, please refer to the technical section.

Funnels, industrial, HDPE



- Rigid industrial funnels in polyethylene
- Unbreakable in normal use
- Feature straight sided upper position to prevent spillage

Product Code	Top I.D. mm	Stem O.D. mm	Overall height mm	Pack qty.
FWC102	80	9	80	10
FWC104	100	11	102	10
FWC106	120	12	121	10
FWC108	140	13	141	5
FWC110	180	17	181	5
FWC112	230	21	226	5
FWC114	245	24	239	1
FWC116	290	27	277	1
FWC118	380	36	351	1





Funnels, powder, plain stem

PYREX®

- Ideal for transferring powders
- With short wide stem for smooth flow
- Manufactured from chemically resistant Pyrex® borosilicate glass

Product Code	Top diam. funnel mm	Stem O.D. x length mm	Pack qty.
2130/02M	80	18 x 25	10



Funnels, powder, stem with cone



- Designed for transferring powders into Quickfit® flasks and vessels
- With Quickfit® ground glass cone
- Manufactured from chemically-resistant Pyrex® borosilicate glass

Product Code	Cone size	Approx funnel diam. (mm)	Pack qty.
CF5/1	14/23	105	1
CF5/2	19/26	105	1
CF5/3	24/29	105	1
CF5/4	29/32	105	1
CF5/5	34/35	105	1



Funnels, powder, polypropylene



- Lightweight polypropylene powder funnel
- Unbreakable in normal use
- Parallel stem minimises 'bridging' of powder
- The two largest sizes have vertical sided tops

Product Code	Top I.D. mm	Stem O.D. mm	Overall height mm	Pack qty.
FWC202	65	18	69	5
FWC204	80	22	74	5
FWC206	100	26	90	5
FWC208	120	30	106	5
FWC210	150	36	135	5
FWC212	290	35	208	1
FWC214	420	48	270	1



Funnels, thistle, polypropylene



- Polypropylene thistle shaped funnel with detachable long stem
- Stem dimensions: 6mm O.D. x 4mm I.D. x 25 mm long
- Stem can be cut to size

Product Code	Approx funnel diam. (mm)	Pack qty.
FWC220	34	10



Funnels, filter, ribbed

PYREX®

- With interior 'ribs' to increase the filtration rate
- Robust construction in Pyrex® borosilicate glass
- Stem length of 150mm

Product Code	Top external diam. mm	Stem O.D. mm	Overall height mm	To suit filter paper diam.	Pack qty.
2150/03M	65	8	196	70-90	10
2150/06M	80	8	210	90-150	10
2150/10M	110	8	235	150-185	10



Funnel, sintered glass disc

PYREX®

- Sintered disc manufactured from Pyrex® borosilicate glass
- For the filtration of solutions:
 - No requirement for filter paper
 - Resistant to most corrosive reagents including ammonia and concentrated sulphuric acid
- Available in a choice of porosities

Product Code	Nom. capacity ml	Porosity grade	Bowl I.D. mm	Overall height mm	Stem O.D. x length mm	Pack qty.
3730/04	20	2	65	130	8 x 75	5
3730/06	20	3	65	130	8 x 75	5
3730/08	20	4	65	130	8 x 75	5
3750/03	30	3	80	144	8 x 82	1



3730 series have 20mm diameter sintered discs, 3750 series have 30mm diameter sintered discs.



Funnels, filter, micro

PYREX®

- With 15mm diameter sintered disc
- Ideal for filtering small amounts of material

Product Code	Nom. capacity ml	Porosity grade	Body O.D. mm	Height exc. stem mm	Stem O.D. x length mm	Pack qty.
3780/02M	8	1	18	135	8 x 40	5
3780/04M	8	2	18	135	8 x 40	5
3780/06M	8	3	18	135	8 x 40	5



Funnels, filter, sintered glass disc, cylindrical

PYREX®

- Manufactured from Pyrex® borosilicate glass
- Ideal for filtering precipitates
- 3770 series 20mm diameter sintered discs
- 3760 series 30mm diameter sintered discs

Product Code	Nom. capacity ml	Porosity grade	Body O.D. mm	Overall height mm	Pack qty.
3760/02	130	1	34	300	1
3760/04	130	2	34	300	1
3760/06	130	3	34	300	1
3770/02	50	1	24	160	2
3770/04	50	2	24	160	2
3770/06	50	3	24	160	2
3770/08	50	4	24	160	2
3770/10	50	5	24	160	2



Funnels, filter, sintered glass disc, Büchner, 30mm diameter

PYREX®

- Comprehensive range of Büchner filter funnels with integral sintered glass discs
- Disc and funnel body manufactured from chemically resistant Pyrex® glass
- For convenient filtration of solutions
 - No filter papers required
 - Highly resistant to most corrosive reagents including ammonia and concentrated sulphuric acid
- Choice of disc diameters and porosities

Product Code	Nom. capacity ml	Porosity grade	Diam. of rim mm	Overall height mm	Stem O.D. x length	Pack qty.
3620/02	30	1	38	160	8 x 100	5
3620/04	30	2	38	160	8 x 100	5
3620/06	30	3	38	160	8 x 100	5
3620/08	30	4	38	160	8 x 100	5
3620/10	30	5	38	160	8 x 100	5



Funnels, filter, sintered glass disc, Büchner, 40mm diameter

Product Code	Nom. capacity ml	Porosity grade	Diam. of rim mm	Overall height mm	Stem O.D. x length	Pack qty.
3630/01	50	0	54	170	8 x 100	5
3630/02	50	1	54	170	8 x 100	5
3630/04	50	2	54	170	8 x 100	5
3630/06	50	3	54	170	8 x 100	5
3630/08	50	4	54	170	8 x 100	5
3630/10	50	5	54	170	8 x 100	5

Funnels, filter, sintered glass disc, Büchner, 60mm diameter

Product Code	Nom. capacity ml	Porosity grade	Diam. of rim mm	Overall height mm	Stem O.D. x length mm	Pack qty.
3700/01	125	0	71	180	13 x 100	5
3700/02	125	1	71	180	13 x 100	5
3700/04	125	2	71	180	13 x 100	5
3700/06	125	3	71	180	13 x 100	5
3700/08	125	4	71	180	13 x 100	5
3700/10	125	5	71	180	13 x 100	5



Funnels, filter, sintered glass disc, Büchner, 95mm diameter

PYREX®

Product Code	Nom. capacity ml	Porosity grade	Diam. of rim mm	Overall height mm	Stem O.D. x length mm	Pack qty.
3710/01	500	0	106	250	19 x 100	5
3710/02	500	1	106	250	19 x 115	5
3710/04	500	2	106	250	19 x 115	5
3710/06	500	3	106	250	19 x 115	5
3710/08	500	4	106	250	19 x 115	5
3710/10	500	5	106	250	19 x 115	5

Funnels, filter, sintered glass disc, Büchner, 120mm diameter

Product Code	Nom. capacity ml	Porosity grade	Diam. of rim mm	Overall height mm	Stem O.D. x length mm	Pack qty.
3720/02M	1000	1	135	290	19 x 120	2
3720/04M	1000	2	135	290	19 x 120	2
3720/06M	1000	3	135	290	19 x 120	2
3720/08M	1000	4	135	290	19 x 120	2

Funnels, filter, sintered glass disc, Büchner, 175mm diameter

Product Code	Nom. capacity ml	Porosity grade	Diam. of rim mm	Overall height mm	Stem O.D. x length mm	Pack qty.
3722/02M	4000	1	190	390	30 x 150	1
3722/04M	4000	2	190	390	30 x 150	1
3722/06M	4000	3	190	390	30 x 150	1
3722/08M	4000	4	190	390	30 x 150	1



For advice on the choice of sinter porosity, please refer to the technical section of the catalogue.



Funnels, filter, Büchner, stem with cone



- Büchner funnel with glass sintered disc
- Borosilicate glass construction for high resistance to chemical attack
- Useful where conventional filter papers would be destroyed by acids and alkalis
- Integral ground glass cone on stem for connecting to Quickfit® Büchner flasks etc.

Product Code	Cone size	Approx disc diameter mm	Approx funnel diam. (mm)	Sintered disc porosity	Pack qty.
SF3A32	19/26	55	71	3	1
SF3A33	24/29	55	71	3	1
SF3A34	29/32	55	71	3	1
SF3B33	24/29	95	106	3	1



Funnels, filter, vacuum Büchner



- Büchner vacuum filtration funnel with glass sintered disc
- Manufactured from borosilicate glass for the high resistance to chemical attack
- Useful where conventional papers would be destroyed by acids and alkalis
- With a Quickfit® ground glass cone to allow direct filtration into Quickfit® Büchner flasks

Product Code	Nom. capacity ml	Porosity grade	Disc diam. mm	Diam. of rim mm	Cone size	Pack qty.
VB30/06M	30	3	30	40	19/26	1
VB30/08M	30	4	30	40	19/26	1
VB40/02M	80	1	40	50	24/29	1
VB40/04M	80	2	40	50	24/29	1
VB40/06M	80	3	40	50	24/29	1
VB40/08M	80	4	40	50	24/29	1
VB60/02M	125	1	60	71	24/29	1
VB60/04M	125	2	60	71	24/29	1
VB60/06M	125	3	60	71	24/29	1
VB60/08M	125	4	60	71	24/29	1
VB95/04M	500	2	95	106	29/32	1
VB95/06M	500	3	95	106	29/32	1
VB95/08M	500	4	95	106	29/32	1





Funnel, sintered glass disc, conical, stem with cone



- Conical shape with glass sintered disc
- Resistant to most corrosive reagents
- Ammonia, sulphuric acid, etc.
- With integral ground glass cone on the stem for connecting to Quickfit® Büchner flasks

Product Code	Cone size	Approx disc diameter mm	Approx funnel diam.	Sintered disc porosity	Pack qty.
SF4A32	19/26	20	45	3	1
SF4B32	19/26	30	80	3	1



Funnels, filter, semi-micro



- Ideal for filtering semi-micro quantities of material
- Fitted with borosilicate glass sintered disc
- Suitable for use with Quickfit® MD: range of receivers

Product Code	Cone size	Approx disc diameter mm	Approx funnel diam.	Sintered disc porosity	Pack qty.
SF4T30	10/19	10	30	3	1
SF4T31	14/23	10	30	3	1



Semi-micro filter receivers



- With side-arm for venting or attachment to vacuum supply
- Ideal for use with Quickfit® semi-micro filter funnels SF4T30 and SF4T31

Product Code	Nom. capacity ml	Socket size	Approx overall height mm	Pack qty.
MD60	5	10/19	95	1
MD61	10	14/23	130	1



Funnel, filter, perforated plate



- With a perforated glass plate (not a sintered disc)
- Plate acts as a support for standard laboratory filter papers
- Useful for quantitative work where recovery of the precipitate is desired

Product Code	Cone size	Approx plate diam. mm	Approx funnel diam. (mm)	Pack qty.
SF42/2	19/26	24	55	1





Funnels, dropping, graduated, PTFE key

MBL®

- Complies to ISO 4800
- Manufactured from borosilicate glass
- With double graduated scale showing approx. volume contained/volume dispensed
- Graduations in white enamel
- With interchangeable PTFE stopcock for grease-free performance
- Supplied with polyethylene stopper

Product Code	Capacity (ml)	Grads. ml	Lowest grad. mark ml	Stopcock bore mm	Stopper size	Pack qty.
FST511	50	1	5	1.5	19/26	1
FST521	100	2	10	1.5	19/26	1
FST531	250	5	25	2.5	24/29	1
FST542	500	10	50	4.0	24/29	1
FST552	1000	20	100	4.0	29/32	1



Funnels, dropping, graduated, PTFE key, with cone

PYREX®

- Complies with ISO 4800
- With interchangeable PTFE key for grease free performance
- Double graduated scale showing volume of liquid contained/delivered
- Stem inside cone for easy fitting to Quickfit® assemblies
- Graduations in white enamel

Product Code	Capacity (ml)	Grads. ml	Stopcock bore mm	Cone and socket size	Pack qty.
443333	50	1	1.5	19/26	1
443340	100	2	1.5	19/26	1
443347	250	5	2.5	29/32	1
443354	500	10	4.0	29/32	1
443360	1000	20	4.0	29/32	1



Funnels, dropping, Rotaflor[®] stopcock, stem with cone



- Complies to ISO 4800
- Funnel stem with ground-glass cone for easy incorporation into the sockets of Quickfit[®] flasks etc.
- Fitted with GP Rotaflor[®] stopcock with PTFE key
 - No lubrication required
 - No contaminating greases
 - No seizure with caustic solutions

Product Code	Nom. capacity ml	Stopcock bore mm	Cone size	Socket size	Pack qty.
D1/11GP	50	3.0	14/23	14/23	1
D1/21GP	100	3.0	14/23	14/23	1
D1/22GP	100	3.0	19/26	19/26	1
D1/32GP	250	3.0	19/26	24/29	1
D1/42GP	500	6.0	19/26	24/29	1
D1/62GP	1000	6.0	19/26	29/32	1



Funnels, dropping, Rotaflor[®] stopcock, open top, with cone



- Complies with ISO 4800
- With stem inside the cone
- Enables easy fitting to the top of Quickfit[®] chromatography columns etc where a protruding stem would be undesirable
- GP Rotaflor[®] stopcock with PTFE key for grease-free performance
- With open top instead of socket for easy addition of solutions
- Economical price

Product Code	Nom. capacity ml	Top I.D. mm	Stopcock bore mm	Cone size	Pack qty.
D3/12	50	28	3.0	19/26	1
D3/22	100	39	3.0	19/26	1
D3/32	250	47	3.0	19/26	1





Funnels, dropping, graduated, glass key

PYREX®

- Complies with ISO 4800 type 4
- Manufactured from Pyrex® borosilicate glass
- With double graduated scale showing approximate volume contained/dispensed
- Graduations in white enamel
- With interchangeable glass key
- Supplied with glass stopper

Product Code	Capacity (ml)	Grads. ml	Stopcock bore mm	Stopper size	Pack qty.
3590/01	50	1	1.5	19/26	1
3590/02	100	2	2.5	19/26	1
3590/04	250	5	2.5	24/29	1
3590/06	500	10	4.0	24/29	1
3590/08	1000	20	4.0	29/32	1

 Spare glass stoppers are detailed on page 247.



Funnels, dropping, graduated, glass key, with cone

PYREX®

- Complies with ISO 4800
- With interchangeable glass key
- Double graduated scale showing volume of liquid contained/delivered
- Stem inside cone for easy fitting to Quickfit® assemblies
- Graduations in white enamel

Product Code	Capacity (ml)	Grads. ml	Stopcock bore mm	Cone and socket size	Pack qty.
443334	50	1	1.5	19/26	1
443341	100	2	1.5	19/26	1
443348	250	5	2.5	29/32	1
443355	500	10	4.0	29/32	1
443361	1000	20	4.0	29/32	1



Funnels, dropping, glass key, stem with cone



- Complies with ISO 4800
- Funnel stem with ground-glass cone for easy incorporation into Quickfit® flasks and assemblies
- Stopcock has interchangeable glass key

Product Code	Nom. capacity ml	Stopcock bore mm	Cone size	Socket size	Pack qty.
D1/00	20	1.5	10/19	10/19	1
D1/11	50	1.5	14/23	14/23	1
D1/21	100	2.5	14/23	14/23	1
D1/22	100	2.5	19/26	19/26	1
D1/32	250	2.5	19/26	24/29	1
D1/42	500	4.0	19/26	24/29	1
D1/62	1000	4.0	19/26	29/32	1



i Stoppers for use with Quickfit® dropping funnels are detailed on page 247.

Funnels, pressure equalising, pear shape, Rotaflo® stopcock



- Complies with ISO 4800
- For use when liquids have to be introduced into vessels under vacuum
- Can also be used with Soxhlets as solvent traps to facilitate recovery at the end of an extraction
- With GP Rotaflo® stopcocks having chemically resistant PTFE keys

Product Code	Nom. capacity ml	Stopcock bore mm	Cone size	Socket size	Pack qty.
DE100/22	100	3.0	19/26	19/26	1
DE100/32	100	3.0	19/26	24/29	1
DE250/32	250	3.0	19/26	24/29	1
DE250/33	250	3.0	24/29	24/29	1
DE250/44	250	3.0	29/32	29/32	1
DE250/55	250	3.0	34/35	34/35	1





Funnels, pressure equalising, cylindrical, graduated, PTFE key **PYREX®**

- Complies with ISO 4800
- With interchangeable PTFE key for grease free performance
- Double graduated scale showing volume if liquid contained/delivered
- For use when liquids have to be added to systems under vacuum
- Stem inside cone for easy fitting to Quickfit® assemblies
- Graduations in white enamel
- Supplied with hollow glass stopper

Product Code	Capacity (ml)	Grads. ml	Stopcock bore mm	Cone and socket size	Pack qty.
443533	50	1	1.5	19/26	1
443540	100	2	1.5	19/26	1
443547	250	5	2.5	29/32	1
443554	500	10	4.0	29/32	1
443560	1000	20	4.0	29/32	1



Funnel, pressure equalising, cylindrical, graduated, glass key **PYREX®**

- Complies with ISO 4800
- With interchangeable glass key
- Double graduated scale showing volume if liquid contained/delivered
- For use when liquids have to be added to systems under vacuum
- Stem inside cone for easy fitting to Quickfit® assemblies
- Graduations in white enamel
- Supplied with hollow glass stopper

Product Code	Capacity (ml)	Grads. ml	Stopcock bore mm	Cone and socket size	Pack qty.
443534	50	1	1.5	19/26	1
443541	100	2	1.5	19/26	1
443548	250	5	2.5	29/32	1
443555	500	10	4.0	29/32	1
443561	1000	20	4.0	29/32	1



Funnels, separating, pear-shape, PTFE key

MBL®

- Complies with ISO 4800
- Borosilicate glass construction
- With PTFE key for non-stick grease-free performance
- Supplied with polyethylene stopper

Product Code	Nom. capacity ml	Stopcock bore mm	Stopper size	Pack qty.
FST211	50	1.5	19/26	1
FST221	100	1.5	19/26	1
FST231	250	2.5	24/29	1
FST242	500	4.0	24/29	1
FST252	1000	4.0	29/32	1
FST274	2000	6.0	29/32	1
FST276	5000	6.0	34/35	1



i FST276 is supplemental to the ISO 4800

Funnels, separating, conical, PTFE key

MBL®

- Complies with ISO 4800
- Manufactured from borosilicate glass
- With PTFE key for grease-free and corrosion-resistant performance
- Supplied with polyethylene stopper

Product Code	Nom. capacity (ml)	Stopcock bore mm	Stopper size	Pack qty.
FST311	50	1.5	19/26	1
FST321	100	1.5	19/26	1
FST331	250	2.5	24/29	1
FST342	500	4.0	24/29	1
FST352	1000	4.0	29/32	1
FST374	2000	6.0	29/32	1



i Spare polyethylene stoppers are available on page 249.



Funnels, separating, Gilson, PTFE key

PYREX®

- Gilson style with long delivery stem for good control of the liquid/liquid interface
- With interchangeable PTFE key for grease free performance
- Supplied with hollow glass stopper

Product Code	Nom. capacity (ml)	Stopcock bore mm	Stopper size	Pack qty.
443038N	60	1.5	14/23	1
443042N	125	1.5	19/26	1
443047N	250	2.5	24/29	1
443054N	500	4.0	24/29	1
443060N	1000	4.0	29/32	1
443065N	2000	4.0	29/32	1
443073N	4000	6.0	34/35	1



For spare glass stoppers, please see page 248.



Funnels, separating, pear-shape, Rotaflo® stopcock



- Complies with ISO 4800
- Manufactured from borosilicate glass
- With GP Rotaflo® PTFE stopcock:
 - No lubrication required
 - No contaminating greases
 - No seizure

Product Code	Nom. capacity (ml)	Stopcock bore mm	Socket size	Pack qty.
D52/50	50	3.0	19/26	1
D52/100	100	3.0	19/26	1
D52/250	250	3.0	24/29	1
D53/500	500	6.0	24/29	1
D24/1L	1000	6.0	29/32	1



Funnels, separating, pear-shape, Rotaflo® stopcock, stem with cone



- Complies to ISO 4800
- Funnel stem with ground-glass cone to facilitate connection to apparatus having Quickfit® sockets
- With GP Rotaflo® stopcock having chemically resistant PTFE key

Product Code	Nom. capacity ml	Stopcock bore mm	Cone size	Socket size	Pack qty.
D2/11GP	50	3.0	14/23	14/23	1
D2/21GP	100	3.0	14/23	14/23	1
D2/22GP	100	3.0	19/26	19/26	1
D2/31GP	250	3.0	14/23	24/29	1
D2/32GP	250	3.0	19/26	24/29	1
D2/42GP	500	6.0	19/26	24/29	1
D2/43GP	500	6.0	24/29	24/29	1
D2/62GP	1000	6.0	19/26	29/32	1



 Spare Rotaflo® keys are available on page 241.

Funnels, separating, conical, Rotaflo® stopcock



- Complies with ISO 4800
- Manufactured from borosilicate glass
- With GP Rotaflo® PTFE stopcock:
 - No lubrication required
 - No contaminating greases
 - No seizure

Product Code	Nom. capacity (ml)	Stopcock bore mm	Socket size	Pack qty.
D91/100	100	3.0	14/23	1
D92/100	100	3.0	19/26	1
D93/250	250	3.0	24/29	1
D93/500	500	6.0	24/29	1





Funnels, separating, pear-shape, glass key

PYREX®

- Complies with ISO 4800 type 2
- Manufactured from Pyrex® glass for corrosion-free performance
- With interchangeable glass key
- Supplied with glass stopper

Product Code	Capacity (ml)	Stopcock bore mm	Stopper size	Pack qty.
2180/02M	50	1.5	19/26	1
2180/04M	100	1.5	19/26	1
2180/06M	250	2.5	24/29	1
2180/08M	500	4.0	24/29	1
2180/10M	1000	4.0	29/32	1
2180/12M	2000	6.0	29/32	1
2180/14M	5000	6.0	34/35	1

i 5L size supplementary to ISO range.



Funnels, separating, conical, glass key, glass stopper

PYREX®

- Complies to ISO 4800 type 1
- Manufactured from chemically resistant Pyrex® borosilicate glass
- With interchangeable ground glass key
- Supplied with glass stopper

Product Code	Capacity (ml)	Stopcock bore mm	Stopper size	Pack qty.
2190/01M	50	1.5	14/23	1
2190/02M	100	1.5	19/26	1
2190/04M	250	2.5	24/29	1
2190/06M	500	4.0	24/29	1
2190/08M	1000	4.0	29/32	1
2190/10M	2000	6.0	29/32	1



Funnels, separating, pear-shape, glass key, stem with cone



- Complies with ISO 4800 type 2
- Funnel stem with cone to allow easy connection to Quickfit® flasks etc.
- Stopcock features interchangeable glass key

Product Code	Capacity (ml)	Stopcock bore mm	Cone size	Socket size	Pack qty.
D2/01	25	1.5	14/23	14/23	1
D2/11	50	1.5	14/23	14/23	1
D2/12	50	1.5	19/26	19/26	1
D2/21	100	1.5	14/23	14/23	1
D2/22	100	1.5	19/26	19/26	1
D2/31	250	2.5	14/23	24/29	1
D2/32	250	2.5	19/26	24/29	1
D2/42	500	4.0	19/26	24/29	1
D2/43	500	4.0	24/29	24/29	1
D2/62	1000	4.0	19/26	29/32	1



i For hollow glass stoppers, please refer to page 247.

Dreschel bottle heads, screwthread connections



- Complies with BS 2461
- Dreschel type
- With detachable plastic connectors for easy fitting of 9mm bore flexible tubing

Product Code	Cone size	Approx. stem length mm	To fit bottle	Pack qty.
MF28/3/125/SC	24/29	130	MF29/3/125	1
MF28/3/250/SC	24/29	175	MF29/3/250	1
MF28/3/500/SC	24/29	215	MF29/3/500	1

i Head and bottle should be ordered separately.





Dreschel bottle head, adjustable



- With screwthread joint which allows height adjustment of the dip tube and hence permits use with either 125ml or 250ml Dreschel bottles
- To fit MF29: series wash bottles

Product Code	Cone size	Thread size	Sidearm O.D. mm	Pack qty.
MF27/3/13	24/29	13	7	1

i Head and bottle should be ordered separately.

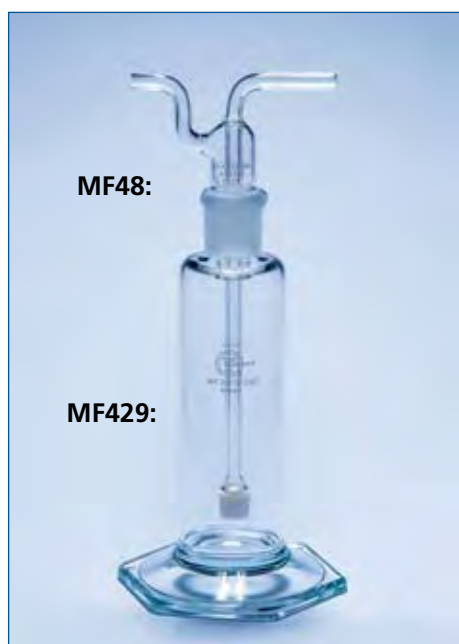

Dreschel bottle heads, sintered



- Complies with BS 2461
- Sintered dip tube disperses gas into bubbles for greater efficiency
- Choice of sinter porosities to achieve fine bubble size

Product Code	Porosity grade	Stem length mm	Sidearm O.D. mm	Cone size	To fit bottle	Pack qty.
MF48/03/125	0	132	8	24/29	MF29/3/125	1
MF48/03/250	0	165	8	24/29	MF29/3/250	1
MF48/03/500	0	217	8	24/29	MF29/3/500	1
MF48/13/125	1	132	8	24/29	MF29/3/125	1
MF48/13/250	1	165	8	24/29	MF29/3/250	1
MF48/13/500	1	217	8	24/29	MF29/3/500	1
MF48/23/250	2	165	8	24/29	MF29/3/250	1
MF48/23/500	2	217	8	24/29	MF29/3/500	1
MF48/33/250	3	165	8	24/29	MF29/3/250	1

i Heads and bottles should be ordered separately.
Finer porosity sinters, e.g. 2 and 3, provide smaller gas bubbles - though a greater pressure may be required.



Dreschel bottles



- For use with Quickfit® bottle heads
- Borosilicate glass for corrosion-free performance
- Robust construction

Product Code	Capacity (ml)	Socket size	Diameter across flat base	Overall height mm	Pack qty.
MF29/3/125	125	24/29	102	163	1
MF29/3/250	250	24/29	102	200	1
MF29/3/500	500	24/29	125	252	1



Hand/finger protectors, silicone rubber



- Ideal for safe handling of hot beakers, flasks etc.
- Capable of withstanding temperatures up to 250°C
- Also excellent for handling cold objects down to -57°C
- Contact surfaces are multi-studded for positive grip

Product Code	Description	Pack qty.
PGR402	Medium	1
PGR404	Small	1
PGR406	Finger	1





Ice bucket with lid, polyurethane



Azlon

- Black, green and blue skinned polyurethane foam ice buckets
- Suitable for use with water-ice, dry-ice and salt solutions
- Ideal for separating work areas by colour
- Supplied with lids
- Integral handles allow easy lifting and carrying
- Octagonal shape for easy stacking and stability
- Capacity 4.5 litres
- Dimensions 185 x 330mm (h x w) and weight 1200g

Product Code	Colour	Pack qty.
IBB001P	Black	1
IBB002P	Pale Blue	1
IBB003P	Green	1



Not suitable for use with solvents or liquid nitrogen.



Mini Ice Bucket

Azlon

- Skinned polyurethane foam mini ice buckets
- Suitable for use with water-ice, dry-ice and salt solutions
- Integral handles allow easy lifting and carrying
- Tapered for easy stacking and stability
- Capacity 1000ml
- Dimensions 95mm x 200mm (h x w) and weight 140g

Product Code	Colour	Pack qty.
IBB004P	Green	1



Not suitable for use with solvents or liquid nitrogen.



Imhoff sedimentation cone

MBL®

- Complies to DIN 12672
- For determining the amount of sediment in sewage or industrial waste
- Graduated up to a capacity mark at 1000ml
- Manufactured from Pyrex® borosilicate glass

Product Code	Capacity (ml)	Pack qty.
CRF530	1000	1



Can be used with stands as detailed below.



Cone, DIN 12672

Azlon

- Colourless, transparent S.A.N cone with moulded graduations
- Graduations from 2 to 1000ml (in mixed graduations)
- The bottom end has a stopper (spare included) to facilitate removal of sample and cleaning

Product Code	Capacity (ml)	Pack qty.
SWX008	1000	1

Sedimentaion rack, PMMA

- Accepts 2 sedimentaion cones side-by-side
- Locating recess in the base for stability

Product Code	Description	Pack qty.
SWX004	Double stand	1





Jerrycans, rigid HDPE



- Lightweight and robust
- Corrosion resistant
- Ideal for storage and transportation of liquid chemicals

Product Code	Capacity litres	Pack qty.
JGH140	1	1
JGH148	5	1
JGH150	10	1
JGH154	25	1



Joints, cones, unbadged



- Unbadged ground glass cones free from any ceramic markings
- Avoids the problem of the badge charring at high temperatures which can give an untidy appearance
- Manufactured to an accuracy which surpasses the requirements of ISO 383
- Pyrex® borosilicate glass for resistance to chemical corrosion and thermal shock
- Cones manufactured with a shank length of 100mm

Product Code	Cone size	Max. O.D. of shank mm	Min. bore mm	Min. wall thickness mm	Pack qty.
CNB7UB	7/16	6.0	2.5	1.50	10
CNB10UB	10/19	9.0	5.0	1.00	10
CNB12UB	12/21	11.4	6.5	1.50	10
CNB14UB	14/23	14.0	8.5	1.50	10
CNB19UB	19/26	18.0	12.0	1.80	10
CNB24UB	24/29	23.0	16.5	1.80	10
CNB29UB	29/32	28.0	21.0	2.00	10
CNB34UB	34/35	33.5	26.0	2.00	10
CNB40UB	40/38	38.8	31.0	2.00	5
CNB45UB	45/40	43.0	35.2	2.30	5
CNB50UB	50/42	49.0	41.8	2.30	5
CNB55UB	55/44	53.0	45.4	2.50	5
CNB60UB	60/46	57.0	47.2	3.50	5



CNB55UB is supplementary to the ISO range.



Joins, cones, drip end, unbadged



- Single Quickfit® cones with angled drip end
- Ideal for Glassblowers fabricating apparatus where liquid needs to be directed away from the joint
 - condensers, fractionating columns, still heads, etc.
- Manufactured to an accuracy which surpasses the requirements of ISO 383
- Drip end cones manufactured with a shank length of 90mm

Product Code	Cone size	Max. O.D. of shank mm	Min. bore mm	Min. wall thickness mm	Pack qty.
CAB10	10/19	8.0	5.0	1.00	10
CAB14	14/23	13.0	6.0	1.50	10
CAB19	19/26	18.0	9.0	1.80	10
CAB24	24/29	22.5	13.0	2.00	10
CAB29	29/32	28.0	18.0	2.00	10
CAB34	34/35	32.0	21.0	2.00	10



Joins, cones, long tip, unbadged



- Single Quickfit® cones with long tip allowing cone to be joined to glass tubing
- Useful for construction of stirrer guides etc.
- Unbadged and free from ceramic markings - avoids the problem of the badge charring at high temperatures which can give an untidy appearance
- Long tip cones manufactured with a minimum shank length of 90mm

Product Code	Cone size	Max. O.D. of shank mm	Min. bore mm	Min. wall thickness mm	Pack qty.
CBB7UB	7/16	6.0	2.0	1.50	10
CBB10UB	10/19	8.0	3.0	1.00	10
CBB14UB	14/23	13.0	6.0	1.50	10
CBB19UB	19/26	18.0	8.0	1.80	10
CBB24UB	24/29	22.5	14.0	2.00	10
CBB29UB	29/32	28.0	19.0	2.00	10
CBB34UB	34/35	32.0	22.0	2.00	10
CBB40UB	40/38	38.0	27.0	2.00	10
CBB45UB	45/40	42.0	31.0	2.30	10
CBB55UB	55/44	52.0	40.0	2.50	10





Joints, cone with stem



- Single Quickfit® cone with stem and reduced shank
- Useful for construction of gas-inlet tubes etc.
- Stem length 150mm

Product Code	Cone size	Min. shank length mm	Max. O.D. of shank mm	Min. bore mm	Min. wall thickness mm	Pack qty.
MF15/1	14/23	45	7.4	4.4	0.9	1
MF15/2	19/26	60	10.4	6.2	1.3	1
MF15/3	24/29	70	10.4	6.0	1.3	1



Joints, sockets, unbadged



- Unbadged ground glass sockets
 - Free from any ceramic markings, avoids the problem of the badge charring at high temperatures which can give an untidy appearance
- High quality joints manufactured to an accuracy which surpasses the requirements of ISO 383
- Accurate taper and fine surface finish reduce possibility of joint 'seizure' or leakage
- With round profile bead on top of socket for extra mechanical strength
- Sockets manufactured with a minimum shank length of 100mm

Product Code	Socket size	Max. O.D. of shank mm	Min. bore mm	Min. wall thickness mm	Pack qty.
SRB7UB	7/16	11.4	5.5	1.50	10
SRB10UB	10/19	14.0	8.0	1.50	10
SRB12UB	12/21	16.4	10.0	1.80	10
SRB14UB	14/23	18.4	12.0	1.80	10
SRB19UB	19/26	23.0	16.0	2.00	10
SRB24UB	24/29	28.5	21.0	2.00	10
SRB29UB	29/32	33.5	26.0	2.00	10
SRB34UB	34/35	41.0	31.0	2.00	10
SRB40UB	40/38	46.0	36.0	2.30	5
SRB45UB	45/40	53.0	41.0	2.50	5
SRB50UB	50/42	57.0	45.5	2.50	5
SRB55UB	55/44	66.5	50.0	3.20	5
SRB60UB	60/46	71.5	55.0	3.20	1



Joins, sleeves, PTFE, tapered



- For grease free and high vacuum seals using Quickfit® ground glass joins
- Strong construction with knurled shoulder for ease of handling and repeated use
- Self-lubricating and non contaminating
- Working temperature range -100°C to +260°C
- Working vacuum $\leq 10^{-3}$ atmospheres
- Highly resistant to chemical attack
- Forms a liquid and gas tight seal



Product Code	Joint size	Pack qty.
SWN802	10/19	1
SWN804	14/23	1
SWN806	19/26	1
SWN808	24/29	1
SWN810	29/32	1
SWN812	34/35	1

Joins, sleeves, PTFE



- Truncated cone of pure PTFE
- Allows easy separation of joins
- Excellent resistance to chemical attack
- Working temperature range of -100°C to +250°C
- Forms a gas tight seal
- No contamination from joint grease
- Intended for single or occasional use
- Suitable for low vacuum work



Product Code	Joint size	Pack qty.
SWN961	14/23	10
SWN962	19/26	10
SWN963	24/29	10
SWN964	29/32	10
SWN965	34/35	10
SWN966	40/38	10
SWN968	50/42	10
SWN969	55/44	10



Joint clips are intended to complement traditional clamping methods. Whilst they can considerably reduce the need for clamping, they should not be solely relied on to support heavy or large apparatus.

Joint clips (PTFE), conical joints



- For retaining glassware having Quickfit® conical joints
- Manufactured from PTFE with encapsulated steel spring to provide a firm grip
- Highly resistant to chemical attack
- Can be used at temperatures up to 250°C
- Clips are numbered with joint size for easy identification

Product Code	Joint size	Pack qty.
GC10	10/19	5
GC12	12/21	5
GC14	14/23	5
GC19	19/26	5
GC24	24/29	5
GC29	29/32	5
GC34	34/35	5
GC40	40/38	5
GC45	45/40	5



Whilst joint clips can considerably reduce the need for traditional clamping, they should not be solely relied on to support heavy or large apparatus.



These clips should not be exposed to halogen gases or acids which can rapidly attack polyacetal. For such applications, the use of Quickfit® PTFE joint clips should be considered.

Joint clips (Polyacetal), conical joints



- For retaining glassware having Quickfit® conical joints
- Manufactured from polyacetal
- Can considerably reduce the need for clamping
- Easy to fit and remove
- Can be used at temperatures up to 80°C
- Clips are colour coded for easy identification

Product Code	Joint size	Colour code	Pack qty.
KC10	10/19	Mint	10
KC12	12/21	Violet	10
KC14	14/23	Yellow	10
KC19	19/26	Blue	10
KC24	24/29	Green	10
KC29	29/32	Red	10
KC34	34/35	Orange	10
KC40	40/38	Ochre	10
KC45	45/40	Brown	10



Quality

Ever since we pioneered the concept of interchangeable jointed glassware more than 70 years ago, Quickfit® has been setting standards of excellence for others to follow. Today over 1200 products carry the famous Quickfit® badge, from adapters and condensers to funnels and flasks, providing the world's widest choice of jointed assemblies.

Manufactured exclusively from Pyrex® borosilicate glass to a specification tighter than those specified by British and international standards, Quickfit® is your guarantee of a leak-free performance and smooth interchangeability, every time.

To find out more about the best jointed glassware money can buy, visit our website.

PYREX® is a registered trademark of Corning Inc.



SciLabware Ltd., Beacon Road, Stone, Staffordshire, ST15 0SA UK
Tel: +44 (0)1785 812121 Fax: +44 (0)1785 815066 www.scilabware.com





Joints, flat flange



- Highest quality flat flange joints
- Precision ground for leak-free performance
- Choice of sizes up to 100mm bore

Product Code	Nom. bore mm	Min. shank length mm	Max. O.D. of shank mm	Outside diam. flange mm	Min. wall thickness mm	Pack qty.
FG25	25	110	30.8	55	1.8	2
FG50	50	110	57.0	85	2.2	2
FG75	75	110	86.8	120	4.4	2
FG100	100	110	116.0	150	4.0	1



JC:

Joint clips (metal)



- For retaining glassware having Quickfit® flat flange joints
- Metal construction available in 2 versions:
 - JC: clips with 'fork' type design and corrosion-resistant nickel finish. Each clip is spring loaded to ensure a positive pressure is applied to both surfaces of the joint. Suitable for joint size FG25
 - JC:F clips with 'spring wire' design in stainless steel. Suitable for joint sizes FG50, FG75 and FG100

Product Code	To fit joint size	Pack qty.
JC41	FG25	2
JC50F	FG50	1
JC75F	FG75	1
JC100F	FG100	1



JC:F



PTFE Seals



- For use with Quickfit® flat flange jointed glassware
- Manufactured from PTFE for excellent chemical resistance
- Forms tight seal with flat flange joints

Product Code	Flange bore mm	Thickness (mm)	Pack qty.
PS75	75	0.5	1
PS100	100	0.5	1



Joins, spherical, male, ball joint, unbadged



- For the Glassblower who demands the highest quality joint
- Manufactured to an accuracy which surpasses the requirements of ISO 641
- Intended for use with female spherical cup joints FS:
- Spherical joints are manufactured with an approximate shank length of 100mm

Product Code	Joint size	Max. O.D. of shank mm	Wall thickness mm	Pack qty.
MS13UB	S13	8.0	1.5	10
MS19UB	S19	12.0	1.5	10
MS29UB	S29	19.0	2.5	10
MS35UB	S35	24.0	2.5	1
MS41UB	S41	28.0	2.8	1



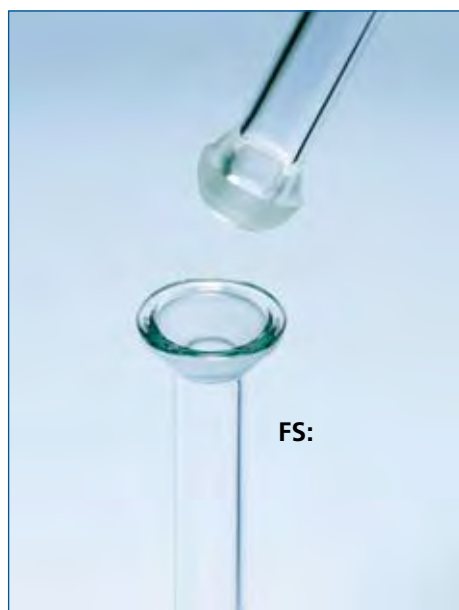

Joints, spherical, female, cup joint, unbadged



- Female cup joints precision manufactured to the highest standards
- For use with male ball joints MS:
- Spherical joints are manufactured with an approximate shank length of 100mm

Product Code	Joint size	Max. O.D. of shank mm	Wall thickness mm	Pack qty.
FS13UB	S13	8.0	1.5	10
FS19UB	S19	12.0	1.5	10
FS29UB	S29	19.0	2.5	10
FS35UB	S35	24.0	2.5	1
FS41UB	S41	28.0	2.8	1



Joint clips (metal), spherical joints



- For retaining glassware having Quickfit® spherical joints
- Metal construction with corrosion-resistant nickel finish
- Suitable for high temperature work
- Spring loaded to ensure a positive pressure is applied to both surfaces of the joint

Product Code	To fit spherical joint size	Pack qty.
JC13	S13	5
JC19	S19	5
JC29	S29	5
JC35	S35	2
JC41	S41	2
JC51	S51	2



Joint clips (Polyacetal), spherical joints



- For retaining glassware having Quickfit® spherical joints
- Manufactured from polyacetal
- Can considerably reduce the need for clamping
- Easy to fit and remove
- Can be used at temperatures up to 80°C
- Clips are colour coded for easy identification



Product Code	To fit joint size	Colour code	Pack qty.
KS13	S13	Violet	5
KS19	S19	Dark Blue	5
KS29	S29	Dark Red	5
KS35	S35	Light Orange	5



Whilst joint clips can considerably reduce the need for traditional clamping, they should not be solely relied on to support heavy or large apparatus.



These clips should not be exposed to halogen gases and acids which can rapidly attack polyacetal. For such applications, the use of Quickfit® PTFE joint clips should be considered.

CUSTOM GLASSWARE MANUFACTURE

- Free quotation without obligation
- Highest quality guaranteed
- All enquiries welcome

Tel: +44 (0)1785 812121
 Fax: +44 (0)1785 815066
 Email: customglass@scilabware.com





Joints, spherical, male/female glass joints

- Offers a 'grease-free' spherical joint
- All glass and PTFE pathway is highly resistant to chemical attack
- Can be used at temperatures up to 200°C
- System comprises male ball joint with PTFE covered 'O' ring which fits into a female cup joint
- Joint can be retained together with spring loaded metal clip

Product Code	Joint size	Max O.D. of shank mm	Approx bore mm	Pack qty.
RM13	13	8	5	5
RM19	19	12	9	5
RM29	29	18	15	5
RM35	35	24	20	5
RM41	41	28	25	5
RM64	64	45	40	5
RF13	13	8	5	5
RF19	19	12	9	5
RF29	29	18	15	5
RF35	35	24	20	5
RF41	41	28	25	5
RF64	64	45	40	5

Joints, spherical, PTFE 'O' ring

Product Code	Description	Pack qty.
RO13	'O' ring to fit RM:RF13	1
RO19	'O' ring to fit RM:RF19	1
RO29	'O' ring to fit RM:RF29	1
RO35	'O' ring to fit RM:RF35	1
RO41	'O' ring to fit RM:RF41	1
RO64	'O' ring to fit RM:RF64	1

Joints, spherical, Viton, 'O' ring

Product Code	Description	Pack qty.
690-12	'O' ring to fit RM:RF13	10
690-13	'O' ring to fit RM:RF19	10
690-14	'O' ring to fit RM:RF29	10
690-15	'O' ring to fit RM:RF35	10
690-16	'O' ring to fit RM:RF41	10
690-18	'O' ring to fit RM:RF64	10

i Minimum shank length of joint is 150mm. Component parts RM:, RF:, RO:, RC: and 690: should be ordered separately.



Joins, spherical, metal clip

ROTULEX®

Product Code	Description	Pack qty.
RC13	Metal clip to fit RM:RF13	1
RC19	Metal clip to fit RM:RF19	1
RC29	Metal clip to fit RM:RF29	1
RC35	Metal clip to fit RM:RF35	1
RC41	Metal clip to fit RM:RF41	1
RC64	Metal clip to fit RM:RF64	1



i Clip RC64 has 3 equidistant fasteners to provide uniform clamping.

Joins, screwthread, unbadged



- For use by Glassblowers in the construction of laboratory glassware
- Borosilicate glass for highest resistance to thermal shock and chemical corrosion
- Designed for use with the range of plastic screwcaps silicone rubber rings and PTFE washers

Product Code	Thread size	Min. shank length mm	Outside diam. shank mm	Min. bore mm	Pack qty.
SQ13UB	13	135	11.1	7.5	10
SQ18UB	18	145	15.4	10.5	10
SQ24UB	24	125	22.5	15.5	10
SQ28UB	28	90	24.5	19.7	10



i Unbadged screwthread joints are free from any ceramic inscriptions thus avoiding the aesthetic problem of 'charring' when the badge is subjected to direct heat. SQ13UB screwthread is compatible with 4510/02 and 4510/04 screwthread connectors featured on page 96.



Joins, screwthread fittings, caps, rings & washers



- For use with Quickfit® glass screwthreads
- Melamine screwcaps with aperture at the top
- Silicone rubber rings with PTFE washers
- To determine what components are required:
 - Check the size of the glass screwthread (size designation refers to O.D. of thread in mm)
 - Check the O.D. of the sampling tube, thermometer, probe etc that is to be passed through the screwcap
 - Consult the table below remembering to order relevant cap, washer and ring separately

Plastic caps

Product Code	Thread size	Acceptable dia. through screwcap mm	Pack qty.
QC13/7	13	6.0 - 7.0	10
QC18/11	18	7.0 - 8.5	10
QC24/12	24	6.0 - 7.0	10
QC28/9	28	6.0 - 7.0	10
QC28/13	28	10.5 - 11.5	10
QC28/21	28	18.0 - 19.0	10

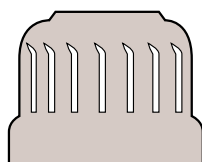

QC:

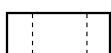

QR:

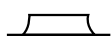

QW:

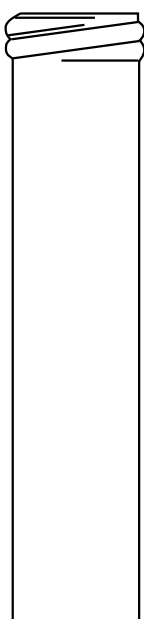

SQ:

Silicone rubber rings

Product Code	Thread size	Acceptable dia. through screwcap mm	Pack qty.
QR13/6	13	6.0-7.0	10
QR18/7	18	7.0-8.5	10
QR24/6	24	6.0-7.0	10
QR24/9	24	8.5-9.5	10
QR24/11	24	10.5-11.5	10
QR28/6	28	6.0-7.0	10
QR28/11	28	10.5-11.5	10
QR28/18	28	18.0-19.0	10

PTFE washers

Product Code	Thread size	Acceptable dia. through screwcap mm	Pack qty.
QW13/6	13	6.0-7.0	10
QW18/7	18	7.0-8.5	10
QW24/6	24	6.0-7.0	10
QW24/9	24	8.5-9.5	10
QW24/11	24	10.5-11.5	10
QW28/6	28	6.0-7.0	10
QW28/11	28	10.5-11.5	10
QW28/18	28	18.0-19.0	10



Jugs, printed graduations, polypropylene



Azlon

- Tapered jugs in high clarity polypropylene
- Crisp blue printed graduations
- Autoclavable at 121°C
- Ergonomically designed handle with thumb grip for easy carrying

Product Code	Capacity (ml)	Sub div. ml	Rim diam. mm	Height mm	Pack qty.
JPB0050P	50	10	50.0	60	5
JPB0100P	100	20	61.0	72	5
JPB0250P	250	50	80.0	100	1
JPB0500P	500	50	102.0	120	1
JPB1000P	1000	100	122.0	150	1
JPB2000P	2000	100	151.0	187	1
JPB3000P	3000	200	172.0	215	1
JPB5000P	5000	500	199.0	253	1



Jugs, moulded graduations, polypropylene



Azlon

- Tapered jugs in high clarity polypropylene
- Permanent moulded graduations
- Autoclavable at 121°C
- Ergonomically designed handle with thumb grip for easy carrying

Product Code	Capacity (ml)	Sub div. ml	Rim diam. mm	Height mm	Pack qty.
JPM0050P	50	2	50.0	60	5
JPM0100P	100	5	61.0	72	5
JPM0250P	250	10	80.0	100	1
JPM0500P	500	10	102.0	120	1
JPM1000P	1000	20	122.0	150	1
JPM2000P	2000	50	151.0	187	1
JPM3000P	3000	50	172.0	215	1
JPM5000P	5000	100	199.0	253	1





Medicine beakers, mercury collector



Medicine measures, polypropylene



- Translucent and robust graduated medicine measures
- Nest to save space
- Ideal for use when taking pH measurements

Product Code	Capacity (ml)	Grads. ml	O.D. (mm)	Height mm	Pack qty.
MWY514	30	1.0	37	42	1
MWY518	50	5.0	50	53	1



Mercury collector, polyethylene



- Spilled mercury is collected by pressing the foam pad in the screw top closure against the mercury
- The mercury is drawn into and encapsulated in the pad by releasing the pressure
- The mercury is released by screwing the closure on to the jar

Product Code	Description	Pack qty.
MWY850	Mercury collector	1
MWY851	Replacement pad	1



Nitrogen determination (Kjeldahl) assembly



- Convenient assembly of Quickfit® glassware for Kjeldahl digestions and distillations
- Flask can be used alone for digestion stage and then fitted to rest of assembly for the distillation process
- Manufactured from heat resistant and chemically durable borosilicate glass

Product Code	Description	Pack qty.
280MC	Complete assembly	1



The determination of nitrogen by the Kjeldahl method imposes severe demands on glassware including high temperatures coupled with alternating acid/alkali conditions.

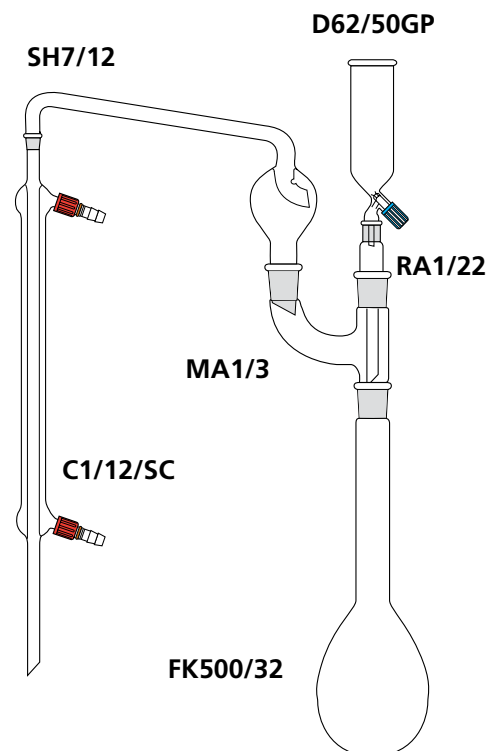

Nitrogen determination, distillation unit, (Markham Still)



- Complies with BS1428: Part B2
- Enables a large number of distillations to be carried out in rapid succession
- Comprises Markham still body, Liebig condenser and connecting joint clip
- Still has evaporator vessel enclosed in a steam jacket
- When connected to a suitable steam supply the steam passes through the sample to promote distillation
- When steam supply is shut off the apparatus automatically sucks back any residue in the vessel thus preparing itself for the next determination

Product Code	Description	Pack qty.
46MC	Complete assembly	1





MBL® pipettes

The measurement of precise volumes of liquid requires high quality volumetric equipment. MBL® products comply with international standards for volumetric ware and are available in Class AS or Class B tolerances. Manufactured from soda lime glass, they have high quality, durable amber stain inscriptions.

Class AS pipettes offer the same exacting levels of accuracy as the traditional Class A, with a 'swift' delivery thanks to a broader jet. The re-engineered jet gives the tip greater mechanical strength making them more robust and less prone to breakage.

In addition to a swift delivery time, Class AS pipettes have a waiting time. This is the time that must be allowed for the

meniscus to settle after dispensing, before a reading can be taken.

MBL pipettes are calibrated at 20 °C to deliver ('Ex') within a thermally controlled environment. The calibration accounts for liquid adhesion to the glass when the liquid is released. This only applies, however, if the specified waiting times for reading the scale are adhered to. The tolerances for graduated pipettes conform to ISO 385 and one mark pipettes conform to ISO 648 and DIN 12690 accuracy limits.

Below is an overview of a typical MBL product, the One-mark pipette.

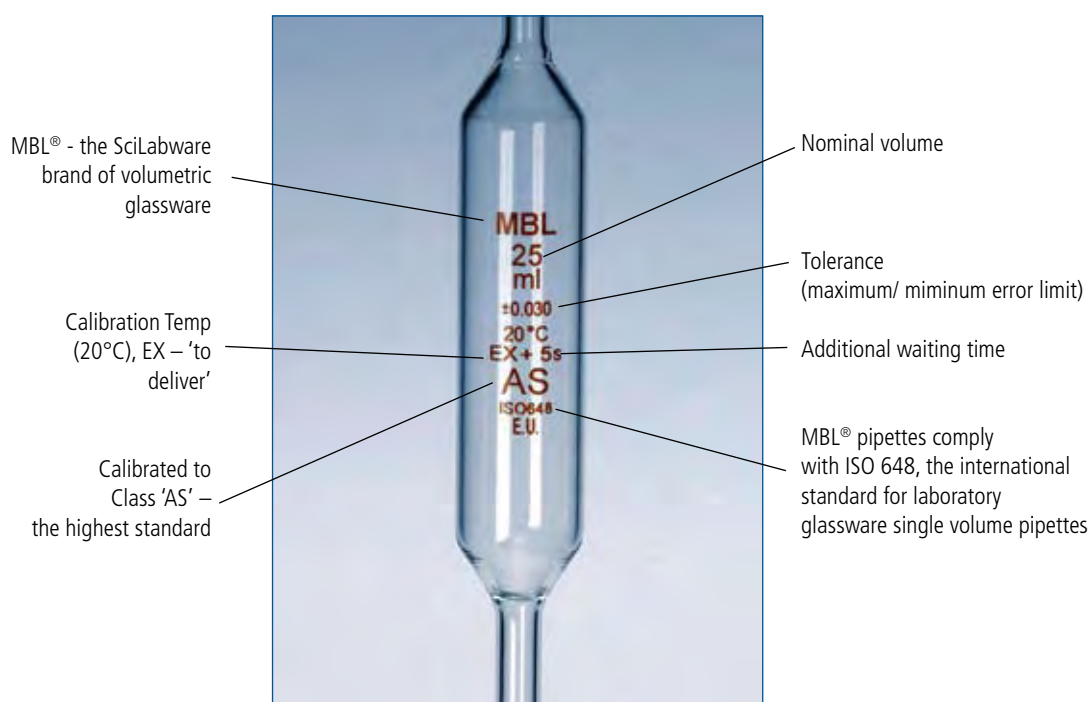

Class AS one mark and graduated pipettes are inscribed with a batch code. Batch certificates for class AS pipettes are available to download from www.scilabware.com/certificates.

We also offer a range of pipette accessories to use in conjunction with MBL® pipettes including pipette fillers, pipette racks and cleaning solutions. See pages 215 and 216.





Pipettes, one mark, class AS, works certified

MBL®

- Complies with ISO 648 and DIN 12691
- Calibrated for delivery with +5s waiting time
- Each pipette coded with individual serial number
- Supplied with calibration certificate which allows traceability to National Standards
- Markings in permanent amber stain which are fused into the glass ensuring highest resistance to aggressive cleaning solutions
- Manufactured from soda-lime glass with tooled jets for extra strength and to ensure correct outflow times

Product Code	Capacity (ml)	Tol. +/- ml	Delivery time seconds	Pack qty.
PRA740ASWC	1	0.008	7-11	2
PRA742ASWC	2	0.010	7-11	2
PRA744ASWC	5	0.015	9-13	2
PRA746ASWC	10	0.020	11-15	2
PRA748ASWC	15	0.030	12-16	2
PRA750ASWC	20	0.030	12-16	2
PRA752ASWC	25	0.030	15-20	2
PRA754ASWC	50	0.050	20-25	2
PRA756ASWC	100	0.080	25-30	2

i PRA748ASWC is supplementary to ISO standard 1 and 2ml one mark pipettes are straight form and do not feature a bulb.



Pipettes, one mark, class AS

MBL®

- Complies with ISO 648 and DIN 12690
- Calibrated for delivery
- Printed with batch code for downloadable batch certificate
- Markings in permanent amber stain
- Class AS with +5s waiting time
- Manufactured from soda-lime glass with robust tooled jets

Product Code	Capacity (ml)	Tol. +/- ml	Delivery time seconds	Pack qty.
PRA720AS	1	0.008	7-11	2
PRA722AS	2	0.010	7-11	2
PRA724AS	5	0.015	9-13	2
PRA726AS	10	0.020	11-15	2
PRA728AS	15	0.030	12-16	2
PRA730AS	20	0.030	12-16	2
PRA732AS	25	0.030	15-20	2
PRA734AS	50	0.050	20-25	2
PRA736AS	100	0.080	25-30	2

i PRA728AS is supplementary to ISO standard. Batch certificates are available to download from www.scilabware.com





Pipettes, one mark, class B

MBL®

- Complies with ISO 648 and DIN 12690
- Calibrated for delivery
- Manufactured from soda-lime glass with tooled jets to reduce breakage
- Markings in permanent amber stain which are diffused into the surface of the glass for increased chemical resistance

Product Code	Capacity (ml)	Tol. +/- ml	Delivery time seconds	Pack qty.
PRA700B	1	0.015	5-20	5
PRA702B	2	0.020	5-25	5
PRA704B	5	0.030	7-30	5
PRA706B	10	0.040	8-40	5
PRA708B	15	0.060	9-50	5
PRA710B	20	0.060	9-50	5
PRA712B	25	0.060	10-50	5
PRA714B	50	0.100	13-60	5
PRA716B	100	0.150	25-60	2

 PRA708B is supplementary to ISO standard.



Pipettes, one mark, class B, polypropylene



Aztore

- Calibrated to meet class B tolerances
- Permanently marked with ring and inscriptions

Product Code	Capacity (ml)	Tol. ± ml	Pack qty.
PDH601	1	0.02	12
PDH602	2	0.02	12
PDH605	5	0.03	12
PDH610	10	0.04	1
PDH625	25	0.05	1
PDH650	50	0.10	1

 Exposure to temperatures above 60°C may affect accuracy. Recommend cleaning with mild alkaline detergents.





Pipettes, two mark, class AS

MBL®

- Complies with ISO 648 and DIN 12690
- Calibrated for delivery
- Printed with batch code for downloadable batch certificate
- Class AS with +5s waiting time
- Features a safety bulb at the top of the pipettes tube
- Manufactured from soda-lime glass with robust tooled jets and permanent amber stain

Product Code	Capacity (ml)	Tol. +/- ml	Delivery time seconds	Pack qty.
PRA620AS	1	0.008	7-11	2
PRA622AS	2	0.010	7-11	2
PRA624AS	5	0.015	9-13	2
PRA626AS	10	0.020	11-15	2
PRA630AS	20	0.030	12-16	2
PRA632AS	25	0.030	15-20	2
PRA634AS	50	0.050	20-25	2
PRA636AS	100	0.080	25-30	2

 Batch certificates can be downloaded from www.scilabware.com

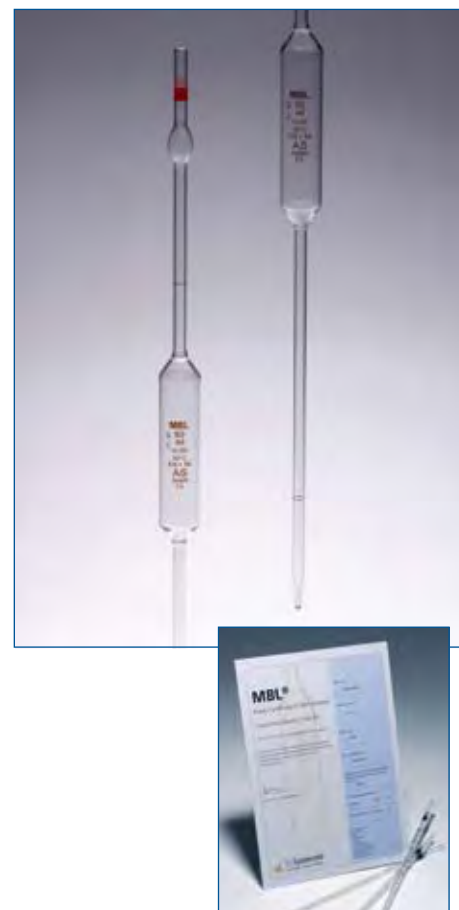

Pipettes, graduated, type 1, class AS, works certified

MBL®

- Complies with ISO 835
- Calibrated to deliver from zero at the top to any graduation line down to the shoulder
- Each pipette is calibrated to deliver with a waiting time of +5s
- Supplied with a calibration certificate showing actual volume dispensed and providing traceability to national standards
- Manufactured from soda-lime glass with tooled jets for extra strength and to ensure correct outflow times
- Graduations in permanent amber stain which resists aggressive washing solutions

Product Code	Capacity (ml)	Grads. ml	Tol. +/- ml	Delivery time seconds	Pack qty.
PRA780ASWC	1	0.01	0.007	4-10	2
PRA782ASWC	2	0.02	0.010	4-10	2
PRA784ASWC	5	0.05	0.030	7-13	2
PRA786ASWC	10	0.10	0.050	7-13	2
PRA788ASWC	25	0.10	0.100	11-17	2





Pipettes, graduated, type 1, class AS

MBL®

- Complies with ISO 835
- Calibrated to deliver from zero at the top to any graduation line down to the shoulder
- Graduations in permanent amber stain which resists aggressive washing solutions
- Each pipette is calibrated 'to deliver' with a +5s waiting time
- Manufactured from soda-lime glass with tooled jets for extra strength and to ensure correct outflow times

Product Code	Capacity (ml)	Grads. ml	Tol. +/- ml	Delivery time seconds	Pack qty.
PRA770AS	1	0.01	0.007	4-10	2
PRA772AS	2	0.02	0.010	4-10	2
PRA774AS	5	0.05	0.030	7-13	2
PRA776AS	10	0.10	0.050	7-13	2
PRA778AS	25	0.10	0.100	11-17	2



Batch certificates are available to download for all Class AS pipettes. To download a batch certificate, visit www.scilabware.com.



Pipettes, graduated, type 1, class B

MBL®

- Complies with ISO 835
- Calibrated to deliver from zero at the top to any graduation line down to the shoulder
- Graduations in permanent amber stain which withstands aggressive cleaning solutions
- Manufactured from soda-lime glass with robust tooled jets

Product Code	Capacity (ml)	Grads. ml	Tol. ± ml	Delivery time seconds	Pack qty.
PRA760B	1	0.01	0.01	2-11	5
PRA762B	2	0.02	0.02	2-12	5
PRA764B	5	0.05	0.05	5-14	5
PRA766B	10	0.10	0.10	5-17	5
PRA768B	25	0.10	0.20	5-15	5



Pipettes, graduated, type 2, class AS, works certified **MBL®**

- Complies with ISO 835
- Calibrated to deliver from any graduation line down to zero at the jet
- Each pipette is calibrated to deliver with a +5s waiting time
- Supplied with calibration certificate showing actual volume dispensed and providing traceability to National Standards
- Manufactured from soda-lime glass with tooled jets for extra strength and to ensure correct outflow times
- Graduations in permanent amber stain which are diffused into the glass to provide highest resistance to chemical attack

Product Code	Capacity (ml)	Grads. ml	Tol. +/- ml	Delivery time seconds	Pack qty.
PRA820ASWC	1	0.01	0.007	4-10	2
PRA822ASWC	2	0.02	0.010	4-10	2
PRA824ASWC	5	0.05	0.030	7-13	2
PRA826ASWC	10	0.10	0.050	7-13	2
PRA828ASWC	25	0.10	0.100	11-17	2



Pipettes, graduated, type 2, class AS

MBL®

- Complies with ISO 835
- Calibrated to deliver from any graduation line down to zero at the jet
- Graduations in permanent amber stain which resists aggressive washing solutions
- Each pipette is calibrated 'to deliver' with a +5s waiting time
- Manufactured from soda-lime glass with tooled jets for extra strength and to ensure correct outflow times

Product Code	Capacity (ml)	Grads. ml	Tol. +/- ml	Delivery time seconds	Pack qty.
PRA810AS	1	0.01	0.007	4-10	2
PRA812AS	2	0.02	0.010	4-10	2
PRA814AS	5	0.05	0.030	7-13	2
PRA816AS	10	0.10	0.050	7-13	2
PRA818AS	25	0.10	0.100	11-17	2



Class AS pipettes are marked with batch information. To download yours, simply visit the certificates section of www.scilabware.com.



Pipettes, graduated, type 2, class B

MBL®

- Complies with ISO 835
- Calibrated to deliver from any graduation line down to zero at the jet
- Graduations in permanent amber stain which is fused into the glass to ensure highest resistance to aggressive washing solutions
- Manufactured from soda-lime glass with robust tooled jets

Product Code	Capacity (ml)	Grads. ml	Tol. ± ml	Delivery time seconds	Pack qty.
PRA800B	1	0.01	0.01	2-11	5
PRA802B	2	0.02	0.02	2-12	5
PRA804B	5	0.05	0.05	5-14	5
PRA806B	10	0.10	0.10	5-17	5
PRA808B	25	0.10	0.20	9-21	5

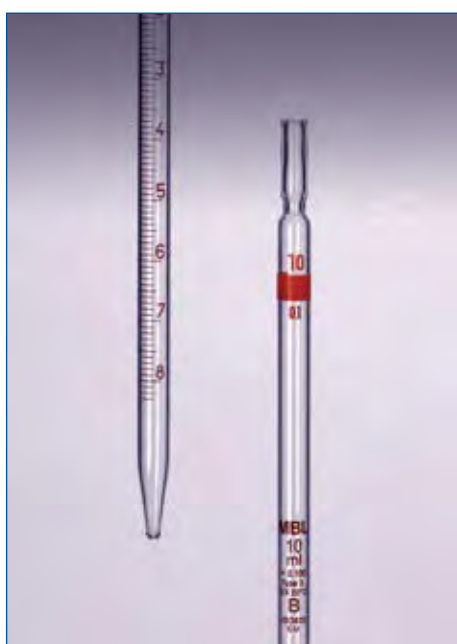

Pipettes, graduated, type 3, class B

MBL®

- Complies with ISO 835
- Calibrated to deliver from zero at the top to any graduation line down to the jet
- Graduations in permanent amber stain which resists aggressive washing solutions
- Manufactured from soda-lime glass with robust tooled rims

Product Code	Capacity (ml)	Grads. ml	Tol. ± ml	Delivery time seconds	Pack qty.
PRA830B	1	0.01	0.01	2-11	5
PRA832B	2	0.02	0.02	2-12	5
PRA834B	5	0.05	0.05	5-14	5
PRA836B	10	0.1	0.10	5-17	5
PRA838B	25	0.10	0.20	9-21	5



Pipettes, graduated, serological, type 4, class B

MBL®

- Complies with ISO 835
- Calibrated to deliver from any graduation line down to zero at the jet with the last drop expelled by blowing
- Tooled suction ends accept cotton-wool plug
- Graduations in permanent amber stain
- Manufactured from soda-lime glass with robust tooled jets

Product Code	Capacity (ml)	Grads. ml	Tol. ± ml	Delivery time seconds	Pack qty.
PRA840S	1	0.01	0.01	2-7	5
PRA842S	2	0.02	0.02	2-7	5
PRA844S	5	0.05	0.05	4-10	5
PRA846S	10	0.10	0.10	4-10	5
PRA848S	25	0.10	0.20	5-15	5



Pipettes, graduated, polypropylene, class B,

Azlon

- Calibrated to class B tolerances
- Easy to read graduation lines
- Specially manufactured tip to ensure excellent quality

Product Code	Capacity (ml)	Grads. ml	Tol. ± ml	Pack qty.
PDH501	1	0.1	0.02	12
PDH502	2	0.1	0.02	12
PDH505	5	0.1	0.05	12
PDH510	10	0.1	0.10	12



Exposure to temperatures above 60°C may affect accuracy. Recommend cleaning with mild alkaline detergents.



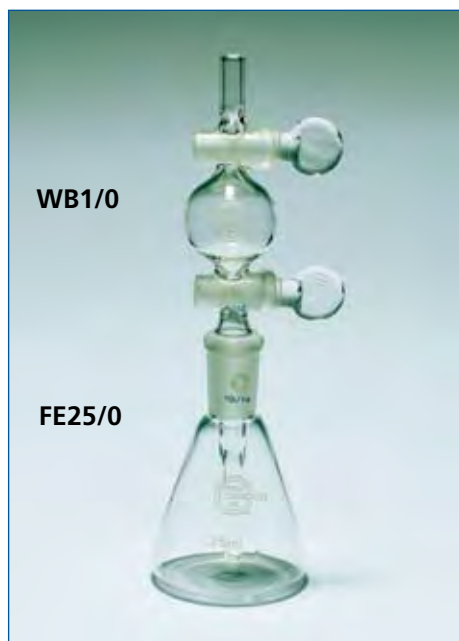

WB1/0

FE25/0

Pipette, weighing



- Specifically designed for weighing fuming or corrosive liquids

Product Code	Description	Joint size	Max. weight g	Approx capacity ml	Pack qty.
WB1/0	Pipette	10/19	18	4	1



Compatible with FE25/0.



Pipettes, dropping, polyethylene



AZLORE

- Corrosion resistant and unbreakable in normal use
- Both sizes are one-piece bellows dispensers
- Plain stem of 7.5 mm diameter

Product Code	Capacity (ml)	Pack qty.
PDH402	1.5	100
PDH408	5	100



Pipette filler, Bibbette®



- A novel PTFE and silicone rubber valve assembly controls the vacuum created by simply squeezing the unique rubber bulb
- By moving the thumb lever pipettes from 0.1ml up to 100ml can be easily and accurately filled and emptied
- Blow out pipettes are catered for by the depression of a small thumb operated squeeze ball
- A replaceable PTFE membrane filter ensures liquid is not accidentally drawn into the unit (2 supplied)
- The filter and pipette holding cone can be sterilised by autoclaving



Product Code	Description	Pack qty.
PFL001B	Bibbette pipette controller, Blue	1
PFL001N	Bibbette pipette controller, Plain	1

Bibbette® accessories

Product Code	Description	Pack qty.
PFL002	Spare membrane filters pack of 10	10
PFL003	Spare suction bulb	1
PFL004	Spare valve system for Bibbette pipette controller	1
PFL006	Spare silicone adapter	1

Pipette fillers, natural rubber



- Suitable for pipettes up to 1000ml
- Pipette filler works via a series of glass ball valves for air release, suction and delivery
- PWY145 is suitable for single handed operation
- PWY146 has an extended insert nozzle for improved grip

Product Code	Pack qty.
PWY144	1
PWY145	1
PWY146	1



Operating instructions for PWY145



1. Evacuate via the automatic valve

2. Intake by pressure on operating point

3. Drain by pressure on operating point

4. Blow out the pipette (no valve actuation necessary)

5. Remove the valve for easy inside cleaning

6. Replace the valve using a twisting motion



Pipette rack, pipette stand



Pipette rack, HDPE



Azlon

- White moulded polyethylene rack
- Will support 12 pipettes over 200 mm long
- Very stable
- Supplied as a kit of two end pieces and three connecting rods for easy push fit assembly

Product Code	Pack qty.
SWP038	1



Pipette stand, polypropylene



Azlon

- Blue chemically resistant polypropylene stand.
- Holds up to 94 pipettes vertically
- Very stable with 230mm diameter base.
- Height of 470mm
- Has a rotatable rack suspended by a support rod

Product Code	Description	Pack qty.
SWP033	Pipette Stand	1



Pipette support, polystyrene



Azlon

- Moulded in white polystyrene
- Simple and efficient pipette rest
- An off-centre support means it is also suitable for short pipettes, burettes, syringes etc.

Product Code	l x w x h mm	Pack qty.
SWP036	280 x 215 x 38	1



Pump, barrel, polypropylene



Azlon

- Suitable for use with acids & alkalis
- Rigid discharge tube
- PTFE gaskets
- Immersion tube diameter 32mm x 1500mm long
- Can be used in conjunction with barrel plug PWJ004

Product Code	Overall length mm	Pack qty.
PWJ003	1590	1



Barrel plug, PVC



Azlon

- Tapered PVC bung for use with 40 - 70mm diameter openings
- Designed for barrel pump PWJ003 (30mm diameter tube)

Product Code	Description	Pack qty.
PWJ004	PVC barrel pump for 40 - 70mm diameter openings	1



Pumps, polypropylene & PVC



Azlon

- Can be used with various sizes of bottles due to telescopic down tube
- Liquid is forced into the collecting vessel by squeezing the bulb
- The flow can be instantly interrupted by pressing the release button
- Can be used as a siphon by attaching tubing to the outlet tube and after pumping the liquid will flow continuously

Product Code	Flow rate litres/min	Stopper O.D. mm	Tube O.D. x length mm	Pack qty.
PWJ014	4	28 x 44	10 x 45	1
PWJ016	12	44 x 60	12 x 70	1
PWJ018	12	52 x 68	12 x 70	1



Can be used with unistoppers on page 218.



Unistoppers, multipurpose, PVC



Azlon

- For use with or without pumps PWJ014/PWJ016/PWJ018
- Consists of three parts, one core and two collars
- Can be used in container openings from 30 - 70mm diameter
- Has 2 apertures, one for inserting tubes and a smaller aperture which acts as an air vent to allow siphoning

Product Code	Description	Pack qty.
PWJ020	Unistopper with 12mm hole for PWJ016	1
PWJ021	Unistopper with 15mm hole for PWJ018	1



Pump, water jet, polypropylene



Azlon

- Suitable for most laboratory water pressures
- Integrated non-return valve increases safety
- Detachable vacuum connection - accepts 6-9mm bore tubing
- Supplied with water inlet hose nipple and R 3/4" threaded tap connectors, with R 1/2" reduction adapter
- Water inlet hose nipple accepts 10-12mm bore tubing
- Very low water consumption: 190 litre/h at 3.5 bar water supply pressure
- A pressure of 16 mbar (water temperature of 12°C) is achievable with a water supply pressure from 3 to 6 bar
- High suction capacity with a flow rate of approx. 400 litres/h of air (at 1 atm and water supply pressure of 3.5 bar at 12°C)

Product Code	Description	Pack qty.
PWD003	Water-jet vacuum pump	1



Jubilee clips are recommended to fix tubing into position.



Racks, draining, coated



Azlon

- High quality free standing or wall mounted draining racks
- Manufactured from polyamide epoxy coated steel
- Offers a better heat and chemical resistance than other coatings
- There are eight pegs 110mm long and twenty four pegs 80mm in length. Peg diameter is 4.5mm
- Overall dimensions of the rack are 410 x 300mm

Product Code	Description	Pack qty.
RWK070FS	Rack with integral free standing support	1
RWK070	Wall mountable	1

 *RWK070 shown.*



Wall mountable draining rack, polystyrene



Azlon

- Lightweight, easy to assemble polystyrene draining racks designed to be wall mounted
- Pegs simply slot into place on the back board and are spaced to allow various sizes of labware to fit on to the rack
- Water is collected in the trough at the base of the rack and drains away via a rubber tube (not supplied) which can be directed into a nearby sink or container
- Supplied with wall mounting accessories
- Measures approximately 650 mm high x 450 mm wide
- A set of narrow pegs for test tubes, volumetric flasks etc. is also available

Product Code	Description	Peg l x O.D. mm	Pack qty.
WRP001P	Rack, including 72 pegs, trough & drain	120 x 16	1
WRP002P	Set of 11 narrow pegs	100 x 6	1



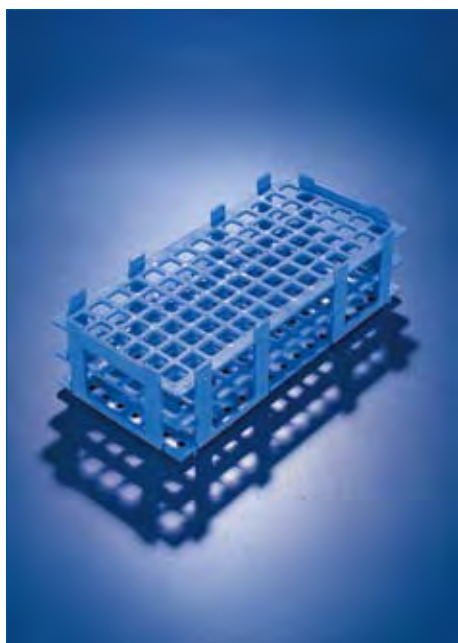

Rack, test tube, polypropylene



Azlon

- Economical and sturdy test tube racks supplied in self assembly flat packs
- Autoclavable at 121°C
- Sinks in water baths
- Alpha numeric place coding

Product Code	Colour	l x w x h mm	Max. tube O.D. mm	No. places	Pack qty.
RPB013P	Blue	265 x 126 x 75	13	84	5
RPW013P	White	265 x 126 x 75	13	84	5
RPB018P	Blue	265 x 126 x 75	18	55	5
RPW018P	White	265 x 126 x 75	18	55	5
RPB021P	Blue	265 x 126 x 75	21	40	5
RPW021P	White	265 x 126 x 75	21	40	5
RPB026P	Blue	265 x 126 x 88	26	32	5
RPW026P	White	265 x 126 x 88	26	32	5
RPB031P	Blue	265 x 126 x 88	31	21	5
RPW031P	White	265 x 126 x 88	31	21	5



Racks, test tube, polyethylene



Azlon

- Simple rack with six holes of 25mm diameter
- Shape ensures good visibility making the rack ideal for classroom work
- Also has 6 draining pegs
- Supplied flat and is very easy to assemble for use or disassemble for storage

Product Code	Pack qty.
RWK030	1



Rack, microcentrifuge tube, polypropylene *A E Azlon*

- Economical and sturdy test tube racks supplied in self assembly flat packs
- Accepts 128 x 1.5ml microcentrifuge tubes
- Autoclavable at 121°C
- Sinks in water baths
- Alpha numeric place coding

Product Code	Colour	l x w x h mm	No. places	Pack qty.
RPB001P	Blue	265 x 126 x 38	128	5
RPR001P	Red	265 x 126 x 38	128	5
RPW001P	White	265 x 126 x 38	128	5
RPY001P	Yellow	265 x 126 x 38	128	5



Racks, microcentrifuge tube, polypropylene *A E Azlon*

- Microcentrifuge tube rack with numerical marking
- Autoclavable at 121°C
- Holds a maximum of 20 tubes

Product Code	Base dim. l x w x h mm	Hole diam. mm	Pack qty.
RWK058	210 x 70 x 35	10	1





Pipette rinser, HDPE

Azlon

- Automatic rinsing system ensuring rapid washing with high-quality results
- Suitable for use with pipette basket RDR306 and pre-cleaning jar RDR304
- Automatically rinses contents when connected to a tap and drain
- Rinses pipettes, burettes and other labware up to 600mm in length

Product Code	Diam. mm	Height mm	Usable length mm	Pack qty.
RDR302	165	740	600	1



Pipette rinser, pre-cleaning jar, HDPE

Azlon

- For pre-cleaning pipettes in cleaning solution prior to rinsing in RDR302

Product Code	Diam. mm	Height mm	Pack qty.
RDR304	165	650	1



Pipette rinser, basket, HDPE

Azlon

- For dipping pipettes into the pre-cleaning jar RDR304 or pipette rinser RDR302
- Suitable for transferring pipettes safely

Product Code	Diam. mm	Overall height mm	Carrier height m	Pack qty.
RDR306	130	650	300	1



Shields, beta radiation, acrylic



Azlon

- High quality shields in 10mm thick acrylic protect against beta radiation
- Angled to allow comfortable working position when examining or handling samples

Product Code	Description	Shield angle degrees	Dimensions (h x w) mm	Pack qty.
SRS001	Angled shield	15	445 x 165	1
SRS002	Dual angled shield	20	445 x 150	1



Shield, safety, hinged type, polycarbonate



Azlon

- Excellent protection in potentially hazardous situations
- Adjustable - can be used as a tight triangle or extended out to a straight line configuration
- Incredibly strong and lightweight
- Supplied with two pairs of plastic coated metal feet
- Feet may be clamped or bolted onto the bench to give greater stability

Product Code	Height cm	Outside panel widths mm	Centre panel width mm	Total width mm	Pack qty.
SGT002	38	180	230	590	1
SGT004	61	180	230	590	1
SGT006	61	226	300	750	1



Shield, safety, hinged type, accessories

Product Code	Description	Pack qty.
SGT012	Spare shield feet	1
SGT014	Shield clamp with hand screw for securing shield feet to the bench	1

Shield, safety, single piece, polycarbonate



Azlon

- Excellent protection in potentially hazardous situations
- Incredibly strong and lightweight
- Manufactured from a single piece of 4mm thick sheet of transparent polycarbonate
- Supplied with two pairs of plastic coated metal feet
- Feet may be clamped or bolted onto the bench to give greater stability

Product Code	Height mm	Outside panel widths mm	Centre panel width mm	Pack qty.
SGT102	608	178	230	1





Scoops, measuring, polypropylene



- Made from food safe polypropylene
- Top is flat for levelling off powders, base is flat enabling scoops to stand horizontally
- The capacity is clearly moulded on each size

Product Code	Capacity (ml)	Overall length mm	Pack qty.
SWL002	2	60	5
SWL006	5	82	5
SWL008	10	102	5
SWL012	25	137	5
SWL018	50	160	5
SWL024	100	198	5
SWL030	250	259	5
SWL036	500	315	5
SWL140	1000	385	1



Scoops, HDPE



- Sturdy scoops in natural rigid polyethylene
- Lightweight with good chemical resistance
- Food safe

Product Code	Max. capacity ml	Overall length mm	Pack qty.
SWL028	150	250	5
SWL033	1000	350	5
SWL040	1500	405	1



Quickfit® sets



Quickfit® sets are designed to cover the requirements of practical chemistry in its many different fields and levels. Capable of performing a range of organic chemistry experiments that includes simple reflux arrangements to more complex addition experiments.

- 29BU/M is a basic starter kit that caters for the beginner chemist
- 27BU caters for more experienced and advanced chemists

All of the apparatus found in both 29BU/M and 27BU sets share the same Quickfit® joint size 14/23. This greatly increases the versatility of the sets, since a wide variety of assemblies can be made up from a small number of components. They are the ideal choice where economy is an important consideration.

The sets are supplied in boxes designed to house all the parts safely in the minimum amount of space. This greatly simplifies the problems of checking equipment as well as providing safe permanent storage.



Set 29BU/M, organic chemistry kit, 14/23 joint size



- Starter kit - ideal for introducing students to the principal techniques of preparative organic chemistry
- Comprises 5 glassware items all with size 14/23 Quickfit® ground-glass joints - giving maximum flexibility
- Scale based on starting material quantities up to 30g
- Both reflux and distillation assemblies can be constructed
- Housed in a robust cardboard box with foam rubber liner for product protection

Product Code	Description
29BU/M	Complete set comprising 5 items of glassware as detailed in the table below

Set 29BU/M, components

Product Code	Key	Description
FP50/1	1	Pear shaped flask, 50ml
SH4/1	2	Stillhead
C1/11/SC	3	Liebig condenser
ST51/13	4	Screwcap adapter
RA1/11	5	Receiver adapter

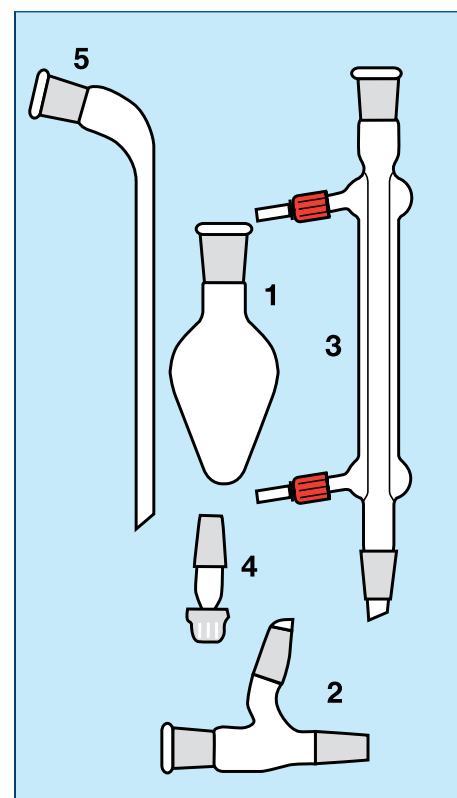

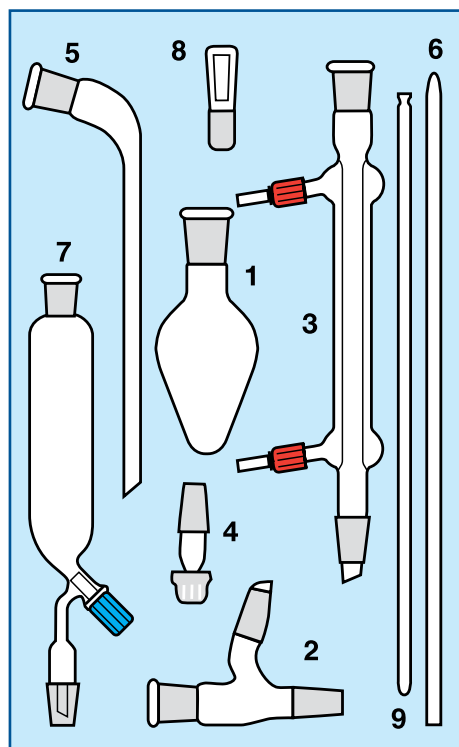

Set 27BU, organic chemistry kit, 14/23 joint size



- The most popular Quickfit® set for schools, colleges and universities
- Comprises 9 basic items of Quickfit® glassware all with size 14/23 ground-glass joints for compatibility
- Allows the construction of at least 8 assemblies including steam distillation, reflux with addition and preparation
- Scale based on starting material quantities up to 30g
- Housed in a robust cardboard box with foam rubber liner to provide safe storage and transit
- Supplied with a CD-ROM which includes practical details of some typical assemblies

Product Code	Description	Pack qty.
27BU	Complete set comprising 9 items of glassware as detailed below	1

Set 27BU, components

Product Code	Key	Description	Pack qty.
FP50/1	1	Pear shaped flask, 50ml	1
SH4/1	2	Stillhead	1
C1/11/SC	3	Liebig condenser	1
ST51/13	4	Screwcap adapter	2
RA1/11	5	Receiver adapter	1
MF5	6	Air leak/steam inlet tube	5
D1/11GP	7	Dropping Funnel, 50ml with GP Rotoflo key	1
SB14	8	Stopper	5
60/110/10	9	Thermometer	10





Slide staining kit



Azlon

- Convenient kit for slide staining, storage and transportation
- Comprises three separate components to be purchased individually

Black polyacetal trough (SWM016)

- Dimensions - 100 x 85 x 55mm deep
- Supplied complete with a push-fit lid and small adapter to aid drainage

Black polyacetal rack (SWM018)

- Has a folding handle for transfer and immersion of slides
- Slotted and numbered for 25 slides
- Fits snugly into the trough whilst the folding handle permits closure of the trough lid during staining

Black polystyrene storage box (SWM020)

- Dimensions - 190 x 170 x 38mm
- Complete with push-fit lid
- Designed to accommodate four of the above racks
- The lid closes tightly with the rack handles down
- Has numbered index sheets for reference
- The box with four racks can be used to store or transport up to 100 slides



Product Code	Description	Pack qty.
SWM016	Trough	1
SWM018	Rack	1
SWM020	Storage box	1



Polyacetal is resistant to alcohol although it is not suitable for phenol.

Slide staining jar



Azlon

- Robust polypropylene jar
- Can hold 10 slides back to back
- Square design conserves space and staining solution
- Useful for staining, biochemical tests, small batches or for mailing of slides

Product Code	Base O.D. mm	Cap O.D. mm	Height mm	Pack qty.
SWM012	33	46	83	1





Spatulas, spotting tile



Spatulas, polypropylene



- Moulded strong tapered spatulas with chamfered ends
- Virtually unbreakable in normal use and retain shape after flexing
- Good chemical and heat resistance
- Autoclavable at 121°C

Product Code	Length (mm)	Pack qty.
SWY060P	115	10
SWY062P	165	10
SWY064P	200	10
SWY066P	245	10



Spotting tile, polypropylene



- High quality spotting tile, unbreakable in normal use
- 12 cavities of approximately 1ml capacity
- Economical alternative to ceramics
- 4mm well depth

Product Code	Dimensions mm	Pack qty.
TWR000P	115 x 95	10



Stand, petri dish, coated



- Holds up to six 90mm petri dishes
- Manufactured from polyamide epoxy coated steel
- Offers a better heat and chemical resistance than other coatings
- Ideal for small batch incubation

Product Code	Pack qty.
SWP062	1



Stand, retort, weighted, polyethylene



- Weighs 2.5kg ensuring stability
- Corrosion resistant
- Polyethylene coated metal rod screws into the base
- Available with the hole in the centre or at the short edge

Product Code	w x l x h mm	Rod position	Rod size mm	Pack qty.
SWP012	171 x 248 x 52	Centre	760 x 12.5	1
SWP014	171 x 248 x 52	Edge	760 x 12.5	1



i A range of burette clamps are featured on page 88.



Sterilising boxes, polypropylene



- Unique cylindrical box for pipette sterilisation
- Autoclavable at 121°C
- The patented telescopic thread closure enables the box length to be altered from 280 to 500mm

Product Code	O.D. (mm)	Length (mm)	Pack qty.
PWP050	65	280-500	1



Stirring bars, magnetic, PTFE



- For the stirring of liquids on magnetic stirrers and hot plates stirrers
- Strong alloy magnets sheathed in pure white inert PTFE
- Supplied in polarity aligned packs to ensure maximum coupling strength
- Resistant to virtually all chemical attack and temperatures up to 260°C

Stirrer bars, magnetic, cylindrical, PTFE

- Plain design with rounded ends, suitable for a wide range of flat bottomed containers

Product Code	Length (mm)	O.D. (mm)	Pack qty.
SWN652	6	3	2
SWN654	8	3	2
SWN656	12	4.5	2
SWN658	15	4.5	2
SWN660	20	6	2
SWN662	25	6	2
SWN664	30	6	2
SWN666	35	6	2
SWN668	40	8	2
SWN670	45	8	2
SWN672	50	8	2
SWN674	60	9	2
SWN676	70	9.5	2
SWN678	80	9.5	2



Stirrer bars, magnetic, micro, PTFE



- For use in small vessels, e.g. test tubes, vials etc.

Product Code	Length (mm)	O.D. (mm)	Pack qty.
SWN950	7	2	2
SWN952	8	1.5	2
SWN954	10	3	2
SWN956	13	3	2



Stirrer bars, magnetic, octagonal, PTFE



- With central pivot ring
- Shape gives increased turbulence at low speeds

Product Code	Length (mm)	O.D. (mm)	Pack qty.
SWN708	13	8	2
SWN710	25	8	2
SWN712	38	8	2
SWN714	51	10	2
SWN716	75	12	2



Stirrer bars, magnetic, oval, PTFE



- For efficient stirring in round bottomed flasks

Product Code	Length (mm)	O.D. (mm)	Pack qty.
SWN520	20	10	2
SWN522	25	12	2
SWN524	30	16	2
SWN525	35	16	2
SWN526	40	20	2
SWN528	50	20	2





Stirrer bars, magnetic, pivot ring, PTFE



- Central pivot ring ensures efficient spinning even on curved or uneven bases

Product Code	Length (mm)	O.D. (mm)	Pack qty.
SWN500	8	3	2
SWN501	15	4.5	2
SWN502	12	4.5	2
SWN503	20	6	2
SWN504	25	6	2
SWN505	35	6	2
SWN506	45	8	2
SWN507	40	8	2
SWN508	60	9.5	2
SWN509	50	8	2
SWN510	70	9.5	2
SWN511	30	6	2



Stirrer Bars, magnetic, triangular, PTFE



- Spins well giving the best possible mixing action
- Ideal for mixing difficult solutions e.g. dissolving solvents or mixing sediments

Product Code	Length (mm)	O.D. (mm)	Pack qty.
SWN532	12	6	2
SWN534	25	8	2
SWN536	35	9	2
SWN538	50	12	2



Stirrer bars, magnetic, set, PTFE



- Useful assortment of the most popular types and sizes of PTFE magnetic stirrer bars
- Supplied in a red polypropylene compartmented box with opaque natural lid
- Contains:
 - Pivot ring: two each of 12 x 4.5 25 x 6 45 x 8 and 60 x 9.5mm
 - Oval: two each of 20 x 10, 25 x 12, 35 x 16 and 50 x 20mm
 - Micro: three each of 7 x 2 and 10 x 3mm

Product Code	Description	Pack qty.
SWN515	Set of 22 PTFE stirrer bars	1

i *Stirring bars only are autoclavable. (Do not autoclave in box)*



Stirrer bar, retrievers, PTFE coated



- Magnet permanently embedded in PTFE rod
- Ideal for retrieving magnetic stirrer bars from particularly sensitive or corrosive liquids

Product Code	Length (mm)	Pack qty.
SWN564	250	1
SWN566	350	1





Stirrer shaft, anchor



- Designed for low speed operation
- Ideal for use with Quickfit® wide-neck reaction flasks FR:F series
- Paddle closely follows the contour of the flask walls
- Useful where the build-up of solid material on the walls is likely
- The minimum neck size required for the stirrer is 100mm

Product Code	Approx shaft diam. (mm)	Approx shaft length mm	Blade width mm	Pack qty.
ST1/5	6	450	90	1
ST1/6	6	600	135	1
ST1/8	11	750	135	1

i Paddle ST1/5 is suitable for use with Quickfit® reaction flasks FR700F and FR1LF. Paddles ST1/6 and ST1/8 are for larger capacity vessels. Reaction flasks are detailed on page 151.

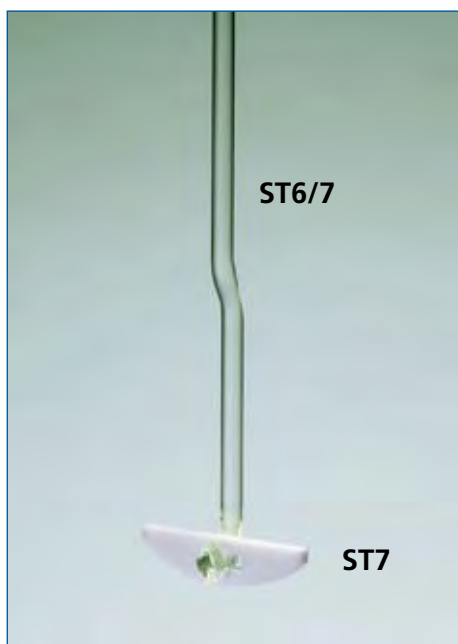

Stirrer, PTFE blade



- PTFE construction for maximum resistance to chemical attack
- PTFE blades can be pivoted on the glass shaft to allow passage through small apertures e.g. necks and sockets of Quickfit® flasks
- Blades are detachable for cleaning and replacement purposes
- Useful for sweeping close to the vessel walls as they will not cause scratching
- For use with glass stirrer shaft detailed below

Product Code	Blade width mm	Min. neck size for stirrer	Pack qty.
ST7/2	52	19/26 Socket	5
ST7/3	76	24/29 Socket	5
ST7/3L	76	24/29 Socket	5

i These PTFE bladed stirrers may be used at temperatures up to 250°C.

Stirrer shaft for PTFE blade

- Pyrex® borosilicate glass construction
- For use with ST7: series PTFE blades

Product Code	To fit PTFE blade	Approx shaft diam. (mm)	Approx shaft length mm	Pack qty.
ST6/7	ST7/2 & ST7/3	6	450	1
ST11/5	ST7/3L	11	750	1



Stirrer shaft, fixed paddle



- Ideal for use with large capacity flasks or Quickfit® wide-neck reaction vessels
- Design of pitched paddle helps to reduce the overall power consumption

Product Code	Approx shaft diam. (mm)	Approx shaft length mm	Min. neck size for stirrer	Blade width mm	Pack qty.
ST1/2	6	610	55/44 Socket	50	1



Stirrer guides



- Designed to reduce excessive 'whip' in glass stirrer shafts which can lead to breakage
- A PTFE bearing is fitted to the bottom of guides ST2/33C/SC and ST2/44C/SC for additional support
- Features a side-arm with detachable plastic connector for the introduction of gases or connection to a vacuum supply

Product Code	To fit stirrer shaft mm	Socket size	Cone size	Approx. stem length mm	Pack qty.
ST2/2/SC	6	19/26	19/26	200	1
ST2/33C/SC	11	24/29	24/29	300	1
ST2/44C/SC	11	29/32	29/32	300	1

 Spare PTFE bearings are available - Item code ST2C.





Stirrer glands, glass



- Used for introducing stirrer paddles into Quickfit® flasks and vessels
- Provides a vapour-tight seal between paddle and flask
- Holds a vacuum down to 0.1 torr (13.3Pa)
- Comprises parallel ground glass sleeve with cup to accept a suitable lubricant (see notes)
- Supplied complete with screwcaps rubber rings and PTFE washers

Product Code	To fit stirrer shaft mm	Cone size	Thread size	Pack qty.
ST20/2	6	19/26	13	1
ST20/3	11	24/29	24	1
ST20/4	11	29/32	24	1

Instructions for use

Lubricant:

The lubricant may be any relatively non-volatile compound suitable for use with the reaction in hand, provided its viscosity does not exceed that of glycerol. Typical lubricants are spindle oil and liquid paraffin.

Speed:

The stirrer should not be run at speeds in excess of 700rpm. When lubricants of high viscosity are used, rotation should commence at approximately 100rpm and should be gradually increased to maximum speed over 10 minutes.

Assembly:

Attach the stirrer to the sleeve of the gland by tightening the plastic screwcap. The gland will be damaged if rotated when dry and the ground surfaces must be smeared with lubricant before assembly. Care must be taken to ensure that the ground surfaces are clean and free from dust or grit before use.



Stirrer glands, PTFE



- 'Stuffing box' glands available with either brass or PTFE cones
- Provides a seal to a stirrer shaft by the adjustable compression of rubber 'O' rings and felt washers impregnated with lubricant
- Glands ST4/2 and ST4/2F have integral drive pulleys

Product Code	Description	Material (cone portion)	To fit stirrer shaft mm	Pulley diam. mm	Cone size	Pack qty.
ST4/2	Gland with pulley	Brass	6	35	19/26	1
ST4/2F	Gland with pulley	PTFE	6	23	19/26	1
ST3/2F	Gland only	PTFE	6	35	19/26	1

Spares for PTFE stirrer glands

Product Code	Description	To fit stirrer shaft mm	Pack qty.
ST4R	Spare 'O' ring	6	10
ST4W	Spare feltwasher	6	10



Rods, stirring, glass

MBL®

- Pyrex® borosilicate glass rods for general stirring applications
- With rounded ends for extra safety and to minimise scratching

Product Code	Diam. mm	Length (mm)	Pack qty.
SRF380	6	300	10



When stirring, avoid the end of the rod abrading the inner surface of glass vessels. Scratches seriously impair the strength of glassware and affected items should not be used.



Rods, stirring, glass, double ended

MBL®

- Manufactured from Pyrex® borosilicate glass rod
- With rounded button and paddle ends for extra safety and to minimise scratching
- Button end is useful for crushing clumped powder and solids
- Paddle end helps to circulate sediment when stirring

Product Code	Diam. mm	Length (mm)	Pack qty.
SRF384	6	200	10
SRF386	6	300	10



When stirring, avoid the end of the rod abrading the inner surface of glass vessels. Scratches seriously impair the strength of glassware and affected items should not be used.



Rods, stirring, PTFE coated

Azlon

- Suitable for stirring even the most corrosive liquids
- Will withstand 260°C
- PTFE covered with plain ends
- 6mm diameter

Product Code	Length (mm)	Pack qty.
SWN542	150	1
SWN544	200	1
SWN546	250	1
SWN548	300	1
SWN550	350	1
SWN552	400	1





Rotaflo® stopcocks

ROTAFLO®

- The following pages show a range of glass/PTFE stopcocks for the discerning glassblower
- Designs that are proven to give great performance
- High performance (HP) Rotaflo® stopcocks for very demanding applications and high vacuum work
 - Each stopcock is individually tested for 10⁻⁹Torr vacuum performance
- General purpose (GP) Rotaflo® stopcocks for general laboratory usage offering fine flow control and greaseless, trouble-free performance



High performance (HP) Rotaflo® stopcocks

ROTAFLO®

High performance Rotaflo® vacuum stopcock providing many significant benefits to the user:

- Borosilicate glass with PTFE key for excellent chemical resistance
- No lubrication required - no seizure and no contamination
- Temperature range from -20°C to 200°C
- Operates over a pressure range of +1bar to 10⁻⁹Torr
- Individually tested by mass spectrometer and supplied with certificate for guaranteed performance
- Locking ring to prevent accidental removal of the key
- Fully interchangeable keys
- Ergonomic key for good grip and easy operation



HP Rotaflo®, plain side-arms, straight pattern

ROTAFLO®

Product Code	Key bore mm	Sidearm bore mm	Sidearm O.D. mm	Approx overall length mm	Pack qty.
HP3ST/5	3.0	5	8	210	1
HP3ST/7	3.0	7	10	210	1
HP6ST/7	6.0	7	10	210	1
HP6ST/10	6.0	10	13	210	1
HP10ST/10	10.0	10	13	225	1

 Side-arms are 100mm in length.



HP Rotaflo[®], plain side-arms, right angle pattern

ROTAFLO[®]

Product Code	Key bore mm	Sidearm bore mm	Sidearm O.D. mm	Approx overall length mm	Pack qty.
HP3RA/5	3.0	5	8	210	1
HP3RA/7	3.0	7	10	210	1
HP6RA/7	6.0	7	10	210	1
HP6RA/10	6.0	10	13	210	1
HP10RA/10	10.0	10	13	225	1

i Side-arms are 100mm in length.



HP Rotaflo[®], three way stopcock

ROTAFLO[®]

Product Code	Key bore mm	Sidearm bore mm	Sidearm O.D. mm	Approx overall length mm	Pack qty.
HP3TW/5	3.0	5	8	215	1
HP6TW/7	6.0	7	10	220	1

i All HP Rotaflo[®] stopcocks are individually tested for 10⁻³ Torr vacuum performance and supplied with test certificate.



HP Rotaflo[®], stopcock spare parts

ROTAFLO[®]

● Replacement keys and locking rings should be ordered separately

Product Code	Description	Bore (mm)	Pack qty.
HP3K	Replacement key	3.0	2
LR3	Locking rings	3.0	5
HP6K	Replacement key	6.0	2
LR6	Locking rings	6.0	5
HP10K	Replacement key	10.0	1
LR10	Locking rings	10.0	5





GP Rotaflo®, plain side-arms, straight pattern

ROTAFLO®

- Rotary design for fine single drop control; invaluable on burettes
- Borosilicate glass with PTFE key for excellent chemical resistance
- No lubrication required - no seizure and no contamination
- Temperature range -20°C to 200°C
- Vacuum capability to 10⁻⁴ Torr
- Increased barrel diameter for excellent drainage
- Locking ring to prevent accidental removal
- Ergonomic key for good grip and easy operation

Product Code	Key bore mm	Sidearm bore mm	Sidearm O.D. mm	Approx overall length mm	Pack qty.
GP3ST/5	3.0	5	8	210	5
GP6ST/7	6.0	7	10	210	5
GP10ST/10	10.0	10	13	225	2

i Side-arms are 100mm in length.



GP Rotaflo®, plain side-arms, right angle pattern

ROTAFLO®

Product Code	Key bore mm	Sidearm bore mm	Sidearm O.D. mm	Approx overall length mm	Pack qty.
GP3RA/5	3.0	5	8	150	5
GP6RA/7	6.0	7	10	165	5
GP10RA/10	10.0	10	13	175	2

i Side-arms are 100mm in length.



GP Rotaflo®, Burette repair stopcock

ROTAFLO®

- With one plain sidearm and one capillary arm drawn to a jet for the repair of burettes

Product Code	Key bore mm	Sidearm bore mm	Sidearm O.D. mm	Approx overall length mm	Pack qty.
GP3BU/5B	3.0	9	12	175	5



GP Rotaflo®, Stopcock spare parts

ROTAFLO®

- Replacement keys and locking rings should be ordered separately

Product Code	Description	Key bore mm	Pack qty.
GP3K	Replacement key	3.0	5
LR3	Locking rings	3.0	5
GP6K	Replacement key	6.0	5
LR6	Locking rings	6.0	5
GP10K	Replacement key	10.0	5
LR10	Locking rings	10.0	5



Stopcocks, plain arms, straight bore, PTFE key

PYREX®

- Manufactured from borosilicate glass with PTFE keys for highest resistance to chemical attack
- Barrels are highly polished and the keys are self lubricating, avoiding the need for stopcock grease
- Keys are fully interchangeable and supplied complete with plastic screw thread retaining device
- Made to a taper of 1:10 giving a combination of performance and ease of operation

Product Code	Key bore mm	Sidearm O.D. mm	Sidearm wall thickness mm	Pack qty.
SST102	1.5	8	1.0	5
SST103	2.5	10	1.0	5
SST104	4.0	10	1.0	5
SST106	6.0	12	1.0	5
SST108	8.0	14	1.5	5



 Spare PTFE keys are available on page 243.

Stopcocks, plain arms, double bore, PTFE key

PYREX®

- Manufactured from borosilicate glass with PTFE keys for highest resistance to chemical attack
- Barrels are highly polished and the keys are self lubricating avoiding the need for stopcock grease
- Keys are fully interchangeable and supplied complete with a retaining device
- Made to a 1:10 taper, giving a combination of performance and ease of operation

Product Code	Key bore mm	Sidearm O.D. mm	Sidearm wall thickness mm	Pack qty.
SST203	2.5	9	1.5	5





Stopcocks, plain arms, T-bore, 3-way, PTFE key

PYREX®

Product Code	Key bore mm	Sidearm O.D. mm	Sidearm wall thickness mm	Pack qty.
SST3025	2.5	9	1.5	5
SST304	4.0	10	1.5	5

i All side-arms are 100mm in length. Spare PTFE keys are available on page 243.



Stopcocks, burette repair, straight bore, PTFE key or glass Key

PYREX®

Product Code	Key bore mm	Key type	Plain arm O.D. x wall mm	Pack qty.
SST502	1.5	PTFE	8 x 1.5	5
SSD502	2.0	Glass	8 x 1.5	1

i One 100mm plain arm and one 70mm capillary arm with drawn jet. For spare keys, please refer to page 243.



Stopcocks, funnel repair, PTFE key

PYREX®

- With one flared end for connection to the base of the funnel and a 100mm long stem with angled tip

Product Code	Key bore mm	Stem O.D. mm	Sidearm wall thickness mm	Pack qty.
SST702	1.5	10	2.2	5
SST703	2.5	10	2.2	5
SST704	4.0	10	2.2	5
SST706	6.0	14	2.5	5

i For spare PTFE keys, please refer to the next page.



Stopcocks, spare PTFE keys

PYREX®

- Fully interchangeable PTFE keys for Pyrex® stopcocks
- Supplied complete with plastic screw thread retaining device
- Keys are self lubricating, avoiding the need for stopcock grease
- Made to a taper of 1:10 giving a combination of performance and ease of operation

Product Code	Key bore mm	Key type	Pack qty.
SST102K	1.5	Straight bore	5
SST103K	2.5	Straight bore	5
SST104K	4.0	Straight bore	5
SST106K	6.0	Straight bore	5
SST203K	2.5	Double bore	5
SST303K	2.5	T-bore	5
SST304K	4.0	T-bore	5



Stopcocks, plain arms, straight bore

PYREX®

- A range of glass stopcocks which meet the specifications of DIN 12541
- Manufactured from borosilicate glass with interchangeable key
- Leakage rate meets the requirements of DIN 12540 i.e. 0.1mbar l/s⁻¹
- Supplied complete with key retaining device

Product Code	Key bore mm	Sidearm O.D. mm	Sidearm wall thickness mm	Pack qty.
SSD102	2.0	8	1.5	1
SSD103	2.5	9	1.5	1
SSD104	4.0	10	1.5	1



i All side-arms are 100mm in length. See below for spare glass keys.

Stopcocks, spare glass keys

PYREX®

- Replacement keys for SSD: series stopcocks
- Manufactured from borosilicate glass
- Supplied complete with key retaining device

Product Code	Key bore mm	Key type	Pack qty.
SSD102K	2.0	Straight bore	1
SSD103K	2.5	Straight bore	1
SSD104K	4.0	Straight bore	1





Stopcocks, straight bore, high vacuum

PYREX®

- These stopcocks are specially designed and carefully manufactured for high vacuum applications
- Each stopcock tested for high vacuum performance.
- Borosilicate glass construction
- Keys and barrels are precision ground together in matched pairs for optimum performance
- Each key and barrel are numbered to ensure they are always paired together
- All side-arms are 100mm in length

Product Code	Key bore size mm	Sidearm O.D. mm	Sidearm wall thickness mm	Pack qty.
SSV103	3	9	1.5	1
SSV104	4	10	1.5	1
SSV106	6	11	1.5	1



Stopcocks, double bore, high vacuum

PYREX®

Product Code	Key bore size mm	Sidearm O.D. mm	Sidearm wall thickness mm	Pack qty.
SSV202	2	8	1.5	1
SSV203	3	9	1.5	1
SSV204	4	10	1.5	1

i All side-arms are 100mm in length.



Stopcocks, T-bore, 3-way, high vacuum

PYREX®

- Pyrex® borosilicate glass construction
- Each key and barrel are numbered to ensure they are always paired together
- All side-arms are 100mm in length

Product Code	Key bore size mm	Sidearm O.D. mm	Sidearm wall thickness mm	Pack qty.
SSV304	4	10	1.5	1



Stopcocks, pump pattern, right angle, high vacuum **PYREX®**

- Ideal for the connection of a vacuum line to a pump mounted at a lower level
- When the stopcock is closed the vacuum created by the pump holds the key securely in place

Product Code	Key bore size mm	Sidearm O.D. mm	Sidearm wall thickness mm	Pack qty.
SSV504	4	10	1.5	1

i All side-arms are 100mm in length.

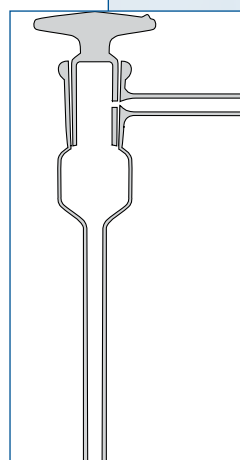

Stopcocks, safety pattern, single-bore, high vacuum **PYREX®**

- Designed to prevent accidental removal of the key whilst the system is under vacuum
- Open ended key features an extra bore 'B':
- When connected to side-arm 'A' the bulb is evacuated thus holding the key firmly in place
 - Key cannot be removed until the vacuum is released

Product Code	Key bore size mm	Sidearm O.D. mm	Sidearm wall thickness mm	Pack qty.
SSV802	2	8	1.5	1
SSV804	4	10	1.5	1

i All side-arms are 100mm in length.

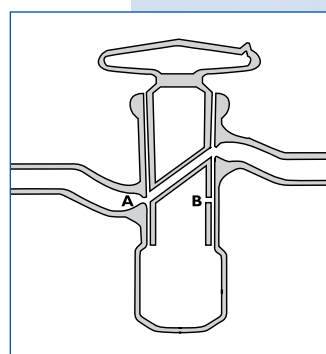



Stopcocks, rigid, polyethylene



Azlon

- Efficient and easily turned stopcock
- 1/2" BSP screw fitting inlet

Product Code	Overall length mm	Bore I.D. mm	Outlet	Pack qty.
SWQ012	100	12	1/2" BSP	1



Stopcocks, white polyethylene



Azlon

- Efficient ball-valve stopcock
- 3/4" BSP thread
- Nominally 12mm bore, the outlet tapers to approximately 9mm O.D.

Product Code	Pack qty.
SWQ018	1



Stopcocks, regulating taps, polypropylene



Azlon

- Efficient polypropylene stopcocks
- Excellent chemical and temperature resistance

Product Code	Thread size BSP	Pack qty.
SWQ036	3/8"	1
SWQ038	1/2"	1
SWQ040	3/4"	1



Remove rubber sealing ring prior to autoclaving.



Stopcocks, 2 way & 3 way, PVDF or Polyethylene



Azlon

- Range of two and three way stopcocks on PVDF or polyethylene
- PVDF has excellent temperature, chemical and ageing resistance
- Polyethylene available for less stringent requirements

Product Code	Material	Type	For tube I.D. mm	Pack qty.
SWQ216	PVDF	2-way	10-11	1
SWQ218	PVDF	3-way	6-7	1
SWQ220	PVDF	3-way	8-9	1
SWQ224	PVDF	3-way	10-11	1
SWQ200	Polyethylene	2-way	6-7	1
SWQ202	Polyethylene	2-way	8-9	1
SWQ204	Polyethylene	2-way	10-11	1
SWQ206	Polyethylene	3-way	6-7	1
SWQ208	Polyethylene	3-way	8-9	1
SWQ210	Polyethylene	3-way	10-11	1



i Polyvinylidene fluoride (PVDF) can be used up to 150°C and has chemical resistance approaching that of PTFE.

Stoppers, hollow-blown glass, 'B' length



- Ideally suited for use with Quickfit® jointedware and other glassware having standard ground glass sockets
- All Quickfit® stoppers conform to the standard tapers as outlined in ISO 383
- Borosilicate glass for chemical durability and high temperature performance
- Hollow-blown construction to reduce weight
- Side indentations to provide finger grip
- Top of stopper is flat or slightly concave, allowing them to be stood on end and avoid contamination of the ground surface

Product Code	Cone size	Overall height mm	Pack qty.
SB7	7/16	32	5
SB10	10/19	46	5
SB12	12/21	52	5
SB14	14/23	56	5
SB19	19/26	61	5
SB24	24/29	67	5
SB29	29/32	75	5
SB34	34/35	82	5
SB40	40/38	87	2
SB45	45/40	95	2
SB55	55/44	101	2





Stoppers, hollow-blown glass, 'C' length



- Ideally suited for use with Quickfit® jointedware and other glassware having the shorter 'C' length ground glass sockets
- Exceeds the requirements of ISO 383
- Borosilicate glass for chemical durability and high temperature performance
- Hollow-blown construction to reduce weight
- Side indentations to provide finger grip
- Top of stopper is flat or slightly concave, allowing them to be stood on end and avoid contamination of the ground surface

Product Code	Cone size	Overall height mm	Pack qty.
2595/01M	10/13	42	20
2595/02M	12/14	47	20
2595/03M	14/15	50	20
2595/05M	19/17	55	20
2595/06M	24/20	61	20
2595/07M	29/22	68	20



Stoppers, hollow-blown glass, with drip tip



- Ideally suited for use with volumetric flasks etc.
- Lower closed end of stopper features a 'drip-tip' to ensure adhered liquid is returned to the flask
- Hexagonal head prevents the stopper from rolling and provides a good grip
- Flat head allows stopper to be stood on end, thus preventing contamination of the ground surface
- Hollow-blown to reduce weight

Product Code	Cone size	Pack qty.
TRF690	7/16	10
TRF691	10/19	10
TRF692	12/21	10
TRF693	14/23	10
TRF695	19/26	10
TRF696	24/29	10
TRF697	29/32	10
TRF698	34/35	5
TRF699	45/40	5



Stoppers, solid glass

PYREX®

- Ideally suited for use with Pyrex® bottles and aspirators
- Robust, solid glass construction
- Hexagonal head to provide a good grip

Product Code	Cone size	Head diam. mm	Overall height mm	Pack qty.
1522/02D	14/15	32	27	10
1522/04D	19/26	36	38	10
1522/05D	24/29	46	42	10
1522/06D	29/32	56	46	10
1522/10D	45/40	77	55	1
1522/12D	60/46	94	62	1



i The two largest sizes are semi-solid to reduce weight.

Stoppers, polyethylene



- Ideally suited for use with glass or plastic volumetric flasks and measuring cylinders etc. which have longer 'B' length sockets
- Manufactured from polyethylene
- Large head provides a good grip and gives protection if glassware is accidentally knocked over

Product Code	Joint size	Pack qty.
TFR590	7/16	10
TRF591	10/19	10
TRF592	12/21	10
TRF593	14/23	10
TRF595	19/26	10
TRF596	24/29	10
TRF597	29/32	10
TRF598	34/35	10





SVL® Glassware

- SVL® glassware has screwthread joints which are easily connected together using purpose made couplings
- Only glass and PTFE come into contact with the chemicals being used to provide a grease-free and corrosion-resistant pathway
- Manufactured from Pyrex® borosilicate glass for maximum resistance to chemical attack and thermal shock
- Screwcaps and couplings in phenolic plastic for heat resistance up to 200°C
- Inserts and sealing rings with PTFE facings for maximum chemical resistance
- Can be assembled to provide sliding and rigid joints. Also positive closures
- No lubrication of joints required, hence no contaminating greases
- Joints and seals can be used under dynamic vacuum conditions. Typical performance 10^{-3} mbar

SVL® connections

Versatile SVL® glassware allows three different types of joints and seals to be made quickly and easily.

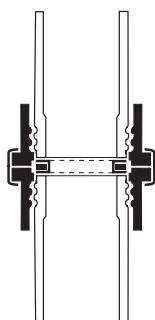

Butt Joint

A rigid butt joint can be made using two threaded tubes of the same diameter. They are connected via a special plastic coupling fitted with a sealing ring. The coupling is independently threaded on both sides to allow desired alignment of apparatus.

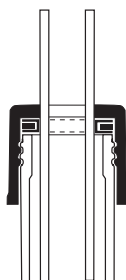

Sliding Joint

Utilises a plastic screwcap having an aperture in the top for fittings to pass through. The latter is secured in position by compression of a sealing ring inside the cap.

All fittings are readily adjustable and the depth of immersion can be altered quickly by slackening the screwcap.

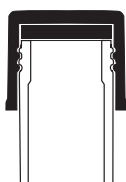

Closure Seal

Utilises a plastic screwcap with a PTFE faced rubber insert. When screwed down onto the glass thread, it provides a closure which is highly resistant to chemical attack.



SVL® glass screwthreads

SVL®

- For use by Glassblowers to construct apparatus with SVL® joints
- Borosilicate glass for highest resistance to thermal shock and chemical corrosion

Product Code	SVL® joint size	Overall length mm	O.D. (mm)	Wall thickness mm	Pack qty.
703-01	15	165	16.0	1.8	10
703-02	22	165	22.5	1.8	10
703-03	30	165	32.0	2.0	10
703-04	42	165	44.1	3.2	10



SVL® glass screwthreads are designed specifically for use with SVL® screwcaps and couplings. They are not compatible with the Quickfit® range of screwcap fittings.



SVL® couplings for butt joints

SVL®

- Plastic coupling and sealing ring designed to secure two SVL® glass screwthreads of the same diameter in a butt joint
- Coupling is manufactured from phenolic plastic and consists of two separately threaded sections
- Sealing ring is manufactured from silicone rubber and sheathed with PTFE for protection against chemical attack. Internal diameter of the ring corresponds to the bore of the SVL® glass screwthread so that flow is not restricted
- Heat resistant up to 200°C

Product Code	SVL® joint size	Ring I.D. mm	Pack qty.
701-11	15	10	10
701-12	22	17	10
701-13	30	23	10
701-14	42	34	10



SVL® sealing rings for butt joints

SVL®

Product Code	SVL® joint size	Ring I.D. mm	Pack qty.
701-01	15	10	10
701-02	22	17	10
701-03	30	23	10
701-04	42	34	10



SVL® screwcaps, for sliding joints

SVL®

- Phenolic screwcaps (with hole) and sealing rings designed to provide a sliding joint
- Ideal for inserting thermometers and glass tubing etc. into an SVL® system
- Sealing rings manufactured from silicone rubber and sheathed with PTFE for protection against chemical attack
- Wide range of sizes for use with tubing from 4.0 to 32.8mm

Product Code	SVL® joint size	Pack qty.
701-41	15	10
701-42	22	10
701-43	30	10
701-44	42	10



Screwcaps and rings should be ordered separately.

SVL® sealing rings, for sliding joints

SVL®

Product Code	SVL® joint size	To accept tubing O.D. mm	Pack qty.
701-19	15	4.0 - 4.4	10
701-21	15	5.6 - 6.4	10
701-22	15	6.6 - 7.4	10
701-23	15	7.6 - 8.4	10
701-51	22	9.6 - 10.4	10
701-52	22	11.6 - 12.4	10
701-24	22	13.6 - 14.4	10
701-25	22	15.6 - 16.4	10
701-56	30	17.6 - 18.4	10
701-26	30	19.5 - 20.5	10
701-27	30	21.5 - 22.5	10
701-28	42	29.2 - 30.8	10
701-29	42	31.2 - 32.8	10



SVL® screwcaps, for positive closure

SVL®

- Designed to act as a positive closure when used with SVL® glass screwthreads
- Manufactured from phenolic plastic with a PTFE faced rubber insert
- Can be autoclaved at 121°C
- Spare rubber/PTFE inserts available

Product Code	Description	Thread size mm	Pack qty.
4503/15	Complete cap	15	20
4503/22	Complete cap	22	20
4503/30	Cap with insert	30	20
4503/42	Cap with insert	42	10
4513/15M	Spare insert	15	20
4513/22M	Spare insert	22	20
4513/30M	Spare insert	30	20
4513/42M	Spare insert	42	10



SVL® adapter, cone/screwthread

SVL®

- Facilitates connection between SVL® and Quickfit® glassware
- Features an SVL® screwthread and Quickfit® ground glass cone
- Thread accepts SVL® screwcaps and couplings. Cone accepts Quickfit® sockets
- Manufactured from temperature and chemical resistant borosilicate glass

Product Code	SVL® joint size	Cone size	Pack qty.
670-70	15	14/23	2
670-77	22	24/29	2
670-83	30	29/32	2



i Screwcap is not provided. Screwcap and adapter should be ordered separately.

SVL®, adapter, socket/screwthread

SVL®

- Facilitates connection between SVL® and Quickfit® glassware
- Features an SVL® screwthread and Quickfit® ground glass socket
- Thread accepts SVL® screwcaps and couplings. Socket accepts Quickfit® cones
- Manufactured from temperature and chemical resistant borosilicate glass

Product Code	SVL® joint size	Socket size	Pack qty.
670-00	15	14/23	2
670-03	22	24/29	2
670-05	30	29/32	2



i Screwcap not provided. Screwcap and adapter should be ordered separately.



SVL®, Torion joints, glass bodies

SVL®

- Alternative jointing system for glassblowers to make connections between tubing and glassware
- Only glass and PTFE come into contact with the liquid being used to provide a chemical resistant pathway
- Complete joint comprises borosilicate glass body, glass filled polypropylene fitting and rubber/PTFE sealing ring
- Glass body has an internal screwthread into which is fitted the rubber sealing ring sheathed with PTFE. Tubing is pushed through the screwthread fitting, which is then threaded onto the glass body. As the fitting is tightened, the sealing ring is compressed to form a seal between the tubing and the body

Product Code	Body height mm	Body max O.D. mm	Shank O.D. mm	Shank length mm	Pack qty.
721-01	27	21	14	8	10
721-02	32	26	17	9	10
721-03	42	37	25	15	10



721-01 supplied with 720-01 fitting and 701-20 sealing ring.
721-02 supplied with 720-02 fitting and 701-23 sealing ring.
721-03 supplied with 720-03 fitting and 701-24 sealing ring.

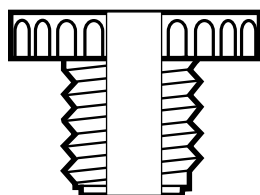

720:



701:

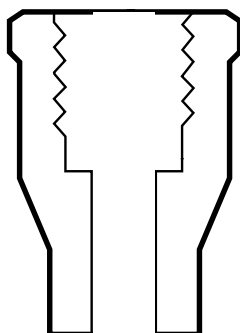

721:

SVL®, Torion joints, spare sealing rings

SVL®

- Spare sealing rings for use with Torion joints to allow tubing of different diameters to be accommodated
- Manufactured from silicone rubber faced with PTFE to protect against chemical attack

Product Code	To suit glass body	To accept tubing O.D. mm	Pack qty.
701-19	721-02	4.0 - 4.4	10
701-20	721-01	4.8 - 5.2	10
701-21	721-02	5.6 - 6.4	10
701-22	721-02	6.6 - 7.4	10
701-23	721-02	7.6 - 8.4	10
701-24	721-03	13.6 - 14.4	10
701-25	721-03	15.6 - 16.4	10
701-51	721-03	9.6 - 10.4	10
701-52	721-03	11.6 - 12.4	10



SVL®, Torion joints, spare fittings

SVL®

- For use with Torion glass bodies and rubber/PTFE sealing rings
- Fittings available in choice of materials
 - Glass filled polypropylene for use at temperatures up to 180°C
 - PTFE for use at temperatures up to 250°C

Product Code	Material	Bore (mm)	Pack qty.
720-01	Polypropylene	5.7	10
720-02	Polypropylene	8.7	10
720-03	Polypropylene	14.7	10
720-04	PTFE	5.7	10
720-05	PTFE	8.7	10
720-06	PTFE	14.7	10

SVL®, stirrer shafts

SVL®

- Designed for use with SVL® stirrer heads and stirrer bearings
- Manufactured from borosilicate glass
 - Lower end with internal screwthread to accept choice of stirrer heads
 - Upper section of shaft is ground to fit choice of stirrer bearings

Product Code	To fit SVL® reaction vessels cap. ml	Shaft length mm	Pack qty.
588-32	500, 1000, 2000	315	1
588-33	1000, 2000, 4000	405	1
588-34	2000, 4000, 6000, 10,000	490	1
588-35	20,000	580	1



Diameter is approximately 10mm on the ground part of the shaft.





SVL®, stirrer heads

SVL®

- Designed for use with SVL® stirrer shafts
- Head simply screws into the end of the shaft
- Manufactured from a PTFE based polymer with the Anchor and Helix types stiffened by a metal core

Product Code	Type	Application	Diameter swept mm	Pack qty.
588-93	Collapsible blades	Vessels with SVL 30 joint or 29/32 socket	70	1
588-94	Paddle	SVL thermostatic reactors	70	1
588-95	Anchor	SVL reaction vessels	90	1
588-97	Helix-6 blades	SVL reaction vessels	80	1
588-98	Anchor	SVL reaction vessels	54	1



Stirrers must be rotated in a clockwise direction to prevent unscrewing of the thread.



SVL®, stirrer Bearings

SVL®

- Designed to accept SVL® stirrer shafts with ground glass surfaces
- Borosilicate glass complete with fittings
- Glands made from a PTFE based polymer which is self lubricating and corrosion-resistant
- Two types available:
 - With SVL® screwthread to allow connection to SVL® flasks
 - With Quickfit® ground glass cone to allow connection to Quickfit® flasks

Product Code	Cone size	SVL thread size	Pack qty.
588-03	-	30	1
588-07	19/26	-	1
588-08	24/29	-	1
588-09	29/32	-	1
588-12	45/40	-	1



Bearings having an SVL® screwthread can be connected to SVL® reaction flasks via SVL® butt joints.



SVL®, spare parts for stirrer bearing

SVL®

- Range of spare parts enabling the user to replace worn components easily and economically

Product Code	Description	Pack qty.
588-00	Torion glass body (without glands)	1
588-92	Spare glands - complete set includes 3 bearings, 2 bushes, 1 spring, 1 washer, 1 screwhead fitting	2
588-99	Spare bearings	10



588-92

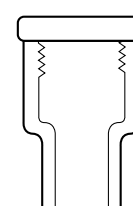

588-00

SVL®, reaction vessels

SVL®

- Manufactured from borosilicate glass for high resistance to chemical attack and thermal shock
- With 100mm wide neck to accept SVL® lids and sealing ring

Product Code	Capacity (ml)	Body O.D. mm	Overall height mm	Shape	Pack qty.
296-54	500	115	120	Cylindrical	1
296-60	1000	115	200	Cylindrical	1
296-72	4000	206	245	Spherical	1
296-75	6000	235	280	Spherical	1
296-80	10000	279	325	Spherical	1
296-84	20000	345	410	Spherical	1



 Lids and sealing rings for use with these reaction vessels are detailed on page 259.



SVL®, jacketed reaction vessel

SVL®

- Ideal for temperature controlled reactions
- With outer jacket through which a temperature controlling medium can be circulated (maximum temperature of 200°C)
- Contents of inner chamber can be run off via a Torion PTFE stopcock
- When used with an SVL® lid and PTFE covered sealing ring, the assembly is grease free and resistant to chemical attack

Product Code	Capacity (ml)	I.D. mm	Total depth mm	Depth of liner mm	Stopcock bore mm	Pack qty.
295-01	1000	100	245	195	8.0	1



The thermostatic reaction vessel is supplied with the following components:

Two olive bends 14mm diameter	X134000695
Two bored caps	701-42
Three sealing rings	701-24
One PTFE stopcock plug	295-00
One screw threaded fitting	720-03

The following parts are required to assemble a complete reaction vessel:

One clamping system	296-91
One pair of support rods	296-92
One sealing ring	296-90
One SVL® lid	296-00/01/02/03

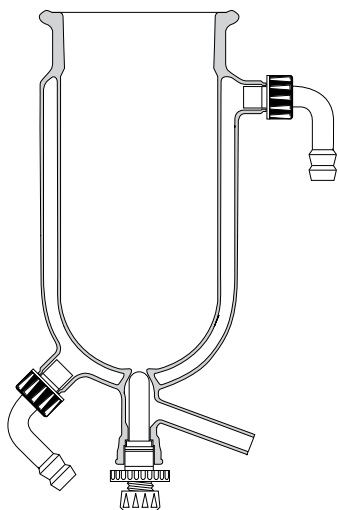

LIPSOL® LABWARE DETERGENT

- Excellent cleaning performance - ideal for use with laboratory glassware and plasticware
- Great value for money
- Totally biodegradable

For full details see page 89





SVL® lids for reaction vessels

SVL®

- For use with SVL® reaction vessels
- Borosilicate glass construction available in 3 styles:
 - Plain with knob (no necks) to act as a cover - 296-00
 - With two necks (one vertical central neck and one vertical side neck)
 - With five necks as shown in the table below

Product Code	SVL joint size central	SVL joint size vertical	SVL joint size vertical 2	SVL joint size angled	Overall height mm	Pack qty.
296-00	-	-	-	-	66	1
296-01	1 x 30	1 x 15	-	-	75	1
296-02	1 x 30	1 x 22	1 x 22	2 x 22	100	1
296-03	1 x 30	1 x 30	1 x 30	2 x 30	100	1



Any SVL® neck will accept SVL® accessories via the use of either butt or sliding joints. Unused necks may be closed with screwcaps. Lids require the use of sealing ring item code 296-90 and clamping system item code 296-91 to effect good fit to reaction vessels. All SVL® reaction vessel lids have an internal diameter of 100mm.



SVL® sealing ring, for reaction vessels

SVL®

- For fitting between the flanges of SVL® reaction vessels and lids
- Silicone rubber sheathed with PTFE to provide a chemically resistant and grease free seal

Product Code	Description	Pack qty.
296-90	Sealing ring	1





SVL® clamping system, for reaction vessels and lids

SVL®

- For securing SVL® lids to reaction vessels
- Manufactured from heat resistant phenolic plastic complete with 6 swivel clamps (296-93) and two milled screws (296-94)

Product Code	Description	Pack qty.
296-91	1 clamping system for 100mm flange (complete)	1
296-93	Pack containing 6 wing nuts, 6 springs and 6 clamps	1
296-94	Pack of 2 milled screws	2



SVL® support rods

SVL®

- Accessory for use with 296-91 clamping system
- Useful for supporting SVL® reaction vessels
- Comprises two metal support rods which are attached to the clamping system via the two milled screws
- Rods can be connected by bossheads to a retort stand or scaffold

Product Code	Description	Diam. mm	Length (mm)	Pack qty.
296-92	2 rods	16	250	1



Always use both of the rods when supporting glassware.



SVL Torion stopcocks, straight pattern

SVL®

- Manufactured from borosilicate glass
- Utilises a Torion joint consisting of a Torion connector, silicone rubber sealing faced with PTFE and a PTFE key
- Vacuum capability to 10^{-2} Torr
- Sidearms are 70 mm in length

Product Code	Key bore mm	Sidearm bore mm	Sidearm O.D. mm	Pack qty.
722-51	5.0	3	8	1
722-52	8.7	5	8	1
722-53	14.7	10	14	1

i 722-51 supplied with 701-01 fitting, 701-20 sealing ring and 720-51 PTFE key.
722-52 supplied with 701-02 fitting, 701-22 sealing ring and 720-52 PTFE key.
722-53 supplied with 701-03 fitting, 701-24 sealing ring and 720-53 PTFE key.



SVL Torion stopcocks, right angle pattern

SVL®

- Manufactured from borosilicate glass
- PTFE key is screwed into the threaded Torion connector, to open and close the stopcock
- No lubrication required - no seizure and no contamination
- Vacuum capability to 10^{-2} Torr
- Sidearms are 70 mm in length

Product Code	Key bore mm	Sidearm bore mm	Sidearm O.D. mm	Pack qty.
722-41	5.0	3	8	1
722-42	8.7	5	8	1
722-43	14.7	10	14	1

i 722-41 supplied with 720-01 fitting, 701-20 sealing ring and 720-51 PTFE key.
722-42 supplied with 720-02 fitting, 701-22 sealing ring and 720-52 PTFE key.
722-43 supplied with 720-03 fitting, 701-24 sealing ring and 720-53 PTFE key.



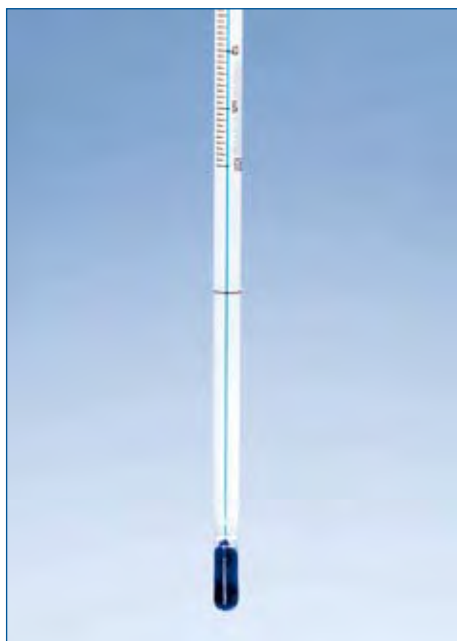

Thermometers, blue spirit filled, white back, partial immersion

MBL®

- Mercury free - filled with safe low toxicity blue indicating fluid
- Calibrated for 'partial immersion' i.e. to give accurate readings when the thermometer is immersed to a specific depth (76mm as marked on thermometer)
- Graduations in permanent amber stain
- White coloured background provides clear observation of blue coloured liquid column
- Reinforced bulb to allow stirring
- With plastic non-roll top and safety suspension ring
- Nominal length 305mm
- Items 60/210/10 and 60/260/10 have a length of 405mm
- Item 60/330/20 has a brown spirit filling

Product Code	Range °C	Grads. °C	Tol. ±°C	Pack qty.
60/050/05	-10 to 50	0.5	0.5	10
60/110/10	-10 to 110	1.0	1.5	10
60/150/10	-20 to 150	1.0	2.0	10
60/210/10	-10 to 210	1.0	3.0	10
60/260/10	-10 to 260	1.0	3.0	10
60/330/20	-10 to 330	2.0	6.0	10

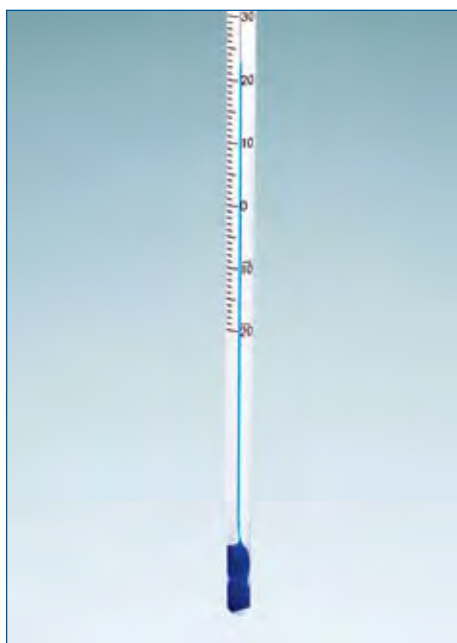

Thermometers, blue spirit filled, white back, total immersion

MBL®

- Mercury free - filled with a low toxicity blue spirit
- Calibrated for 'total immersion'
- Permanent amber stain graduations
- White coloured background provides clear observation of blue coloured liquid column
- Reinforced bulb for stirring
- With plastic non-roll top and safety suspension ring
- Nominal length 305mm with item 30/210/10 length 405mm

Product Code	Range °C	Grads. °C	Tol. ±°C	Pack qty.
30/050/05	-10 to 50	0.5	0.5	10
30/110/10	-20 to 110	1.0	1.0	10
30/150/10	-20 to 150	1.0	1.5	10
30/210/10	-10 to 210	1.0	2.0	10



If a 'total immersion' thermometer is used with a portion of the spirit column above the liquid level, a correction to the observed reading may be required.



Thermometers, low temperature, red spirit filled, white back, total immersion

MBL®

- Mercury free - filled with safe, red, low toxicity fluid
- White background provides clear observation of red coloured liquid column
- Calibrated for 'total immersion' i.e. to give accurate readings when the top of the spirit column is level with the liquid level
- 305mm in length

Product Code	Range °C	Grads. °C	Tol. ±°C	Pack qty.
10/050/10	-100 to +50	1.0	3.0	10

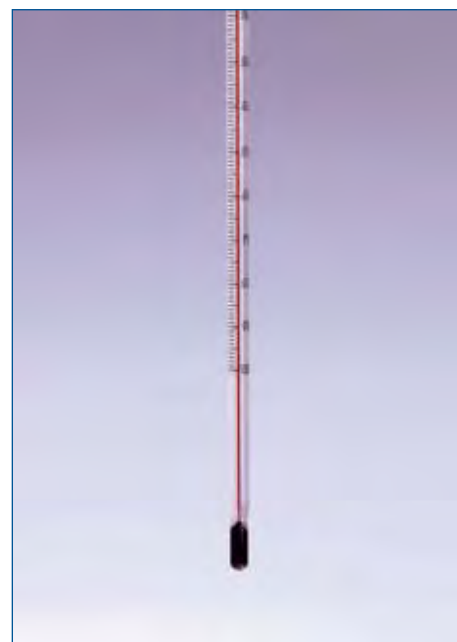

Thermometers, mercury filled, yellow back, total immersion

MBL®

- Calibrated for 'total immersion'
- Permanent amber stain graduations
- Yellow backed tubing for clear observation of mercury column
- Reinforced bulb for stirring
- With plastic non-roll top and safety suspension ring
- Nominal length 305mm

Product Code	Range °C	Grads. °C	Tol. ±°C	Pack qty.
20/110/05	-20 to 110	0.5	0.5	10
20/110/10	-20 to 110	1.0	1.0	10
20/150/10	-20 to 150	1.0	2.0	10
20/200/10	-10 to 200	1.0	2.0	10
20/250/10	-10 to 250	1.0	2.0	10
20/300/10	-10 to 300	1.0	3.0	10
20/360/10	-10 to 360	1.0	4.0	10

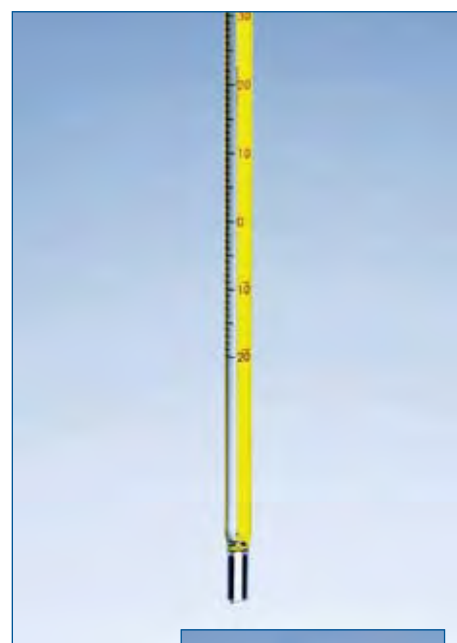

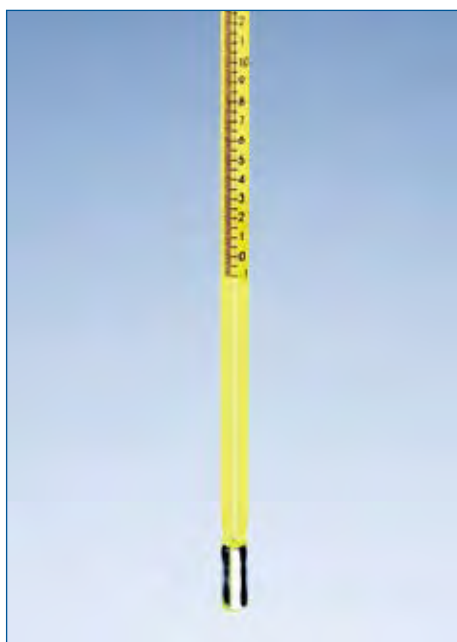

Thermometers, precision, mercury filled, yellow back, total immersion

MBL®

- Precision thermometers calibrated to closer tolerances and graduated at smaller intervals than general purpose thermometers
- Very fine etched graduations with black ceramic filling
- Yellow backed tubing for clear observation of mercury column
- Calibrated for 'total immersion'

Product Code	Range °C	Grads. °C	Tol. ±°C	Length (mm)	Pack qty.
40/101/02	-1 to 101	0.2	0.3	0	10



Thermometers, 'Bee-ka', mercury filled, yellow back, total immersion

MBL®

- Short length (155mm) for use with small beakers and Erlenmeyer flasks etc.
 - Can be left stood in a 50ml beaker without causing it to fall over
- Calibrated for 'total immersion'
- Permanent amber stain graduations
- Yellow back tubing for clear observation of mercury column

Product Code	Range °C	Grads. °C	Tol. ±°C	Pack qty.
50/050/05	-10 to 50	1.0	0.5	10
50/110/10	-10 to 110	1.0	1.0	10
50/250/50	-10 to 250	2.0	4	10

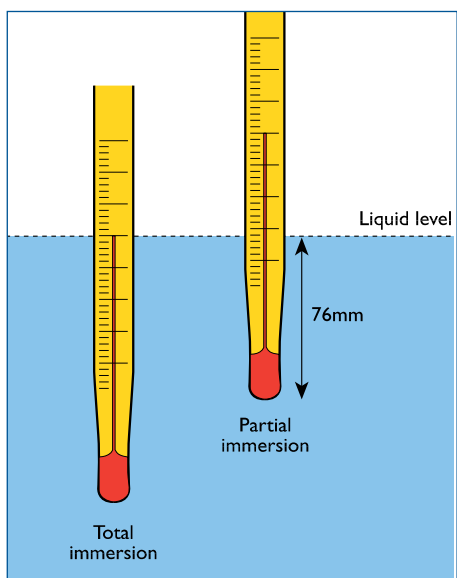

Immersion data

MBL® thermometers are calibrated for use as follows:

Total immersion:

Calibrated to give accurate readings when thermometer is immersed so that the top of the mercury column is level with the liquid surface.

Partial immersion:

Calibrated to give accurate readings when the thermometer is immersed to a specified depth, usually 76mm. The depth to which the thermometer should be immersed is clearly marked on the body.



Thermometers, mercury, with integral cone



- Features an integral ground glass cone on the stem which allows direct fitting into Quickfit® jointed apparatus
- Mercury filled thermometers with enclosed blue ribbon on scale for improved visibility

Product Code	Cone size	Range °C	Pack qty.
MF31/0/110	10/19	-10 to 110	1
MF31/0/250	10/19	-10 to 250	1
MF31/0/360	10/19	-10 to 360	1
MF31/1	14/23	-10 to 110	1
MF31/2	14/23	-10 to 250	1
MF31/3	14/23	-10 to 360	1



Thermometers, spirit, with integral cone



- Features an integral ground glass cone on the stem which allows direct fitting into Quickfit® jointed apparatus
- Filled with high visibility blue spirit

Product Code	Cone size	Range °C	Pack qty.
MF31/2S	14/23	-10 to 250	1





Thermometer adapter



- Ideal for incorporating MBL® and plain stemmed thermometers into Quickfit® jointed glassware assemblies
- Screwthread joint allows easy depth adjustment of thermometer
- Complete with cap, ring and washer

Product Code	Thread size	Cone size	Acceptable dia. through screwcap mm	Pack qty.
ST51/13	13	14/23	6.0 - 7.0	2
ST52/13	13	19/26	6.0 - 7.0	2
ST53/13	13	24/29	6.0 - 7.0	2
ST54/13	13	29/32	6.0 - 7.0	2



Thermometer pocket



- For incorporating thermometers into Quickfit® jointed-ware assemblies
- Pocket fits most Quickfit® still heads

Product Code	Cone size	Approx. stem length mm	Pack qty.
SH4A	14/23	45	1



Trays, instrument, polypropylene



- Rectangular fabricated polypropylene trays
- Rigid and robust
- All sizes have 22mm deep vertical sides
- Can be autoclaved at 121°C

Product Code	Dimensions l x w mm	Pack qty.
TWR018	350 x 200	1
TWR020	350 x 250	1
TWR022	610 x 350	1



Trough, multipurpose, polyethylene



Azlon

- Rectangular robust "heavy-walled" trough
- Will stack inside each other for storage
- Capacity 3 litres

Product Code	External dimensions mm	Pack qty.
TGJ052	325 x 190 x 75	1



Trough, pneumatic, polyethylene



Azlon

- Cylindrical, one piece pneumatic troughs
- Much lighter than glass
- Will withstand up to 80°C

Product Code	O.D. x height mm	Pack qty.
TGJ058	200 x 100	1
TGJ060	250 x 100	1
TGJ062	300 x 150	1



Troughs, sterilising, polypropylene



Azlon

- Rectangular sterilising troughs
- Robust and deep to accommodate a wide range of instruments etc.
- Can be autoclaved at 121°C

Product Code	Capacity litres	l x w mm	Height without lid mm	Height with lid mm	Pack qty.
TWR202	1	210 x 122	78	91	1
TWR204	10	390 x 290	110	130	1

Troughs lids, sterilising, polystyrene

- Lids are to be purchased separately and are not autoclavable

Product Code	Description	Pack qty.
TWR203	Lid for TWR202	1
TWR205	Lid for TWR204	1



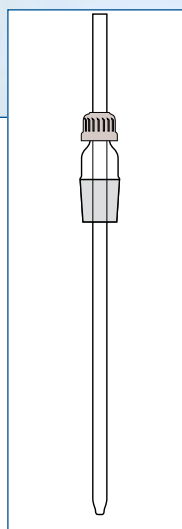

Tube, plain, drawn to jet



- Plain borosilicate glass tube with jet
- Designed to fit the range of Quickfit® thermometer/inlet adapters having size 13 thread

Product Code	Approx O.D. mm	Approx length mm	Pack qty.
MF5	7	325	5

i For thermometer/inlet adapters, please refer to page 266.



Tubes, air/steam inlet, straight pattern



- Designed for introducing gases etc. into Quickfit® assemblies
- Stem with integral ground glass cone to fit Quickfit® sockets
- Lower end of tube is left plain for Glassblower to cut to length and draw to jet

Product Code	Cone size	Approx. stem length mm	Pack qty.
MF15/1	14/23	150	1
MF15/2	19/26	150	1
MF15/3	24/29	150	1



Tubes, air/steam inlet, 90° bend



- With detachable plastic screwthread connector to facilitate the attachment of 9mm bore flexible tubing
- Ground glass cone on stem fits Quickfit® sockets
- Lower end of tube left plain for Glassblower to cut to length and draw to jet

Product Code	Cone size	Approx. stem length mm	Pack qty.
MF15/1B/SC	14/23	150	1
MF15/2B/SC	19/26	150	1
MF15/3B/SC	24/29	150	1



Tube, centrifuge, conical base, graduated

PYREX®

- Centrifuge tube with white enamel graduations
- Graduated 0 - 3ml in 0.1ml divisions and 3 - 10ml in 0.5ml divisions
- Manufactured from Pyrex® borosilicate glass
- Can be centrifuged up to 3000 RCF values

Product Code	Capacity (ml)	Highest mark ml	Diam. mm	Length (mm)	Pack qty.
3460/02M	15	10	17	110	40



Always examine centrifuge tubes before use. Do not use if scratched, chipped or abraded.

Tube, centrifuge, conical base, plain

PYREX®

- Manufactured from chemically inert Pyrex® glass for contamination-free performance
- Conical shape with rim
- Can be centrifuged up to 3000 RCF values

Product Code	Capacity (ml)	Diam. mm	Length (mm)	Pack qty.
1680/02M	15	17	110	40





Tube, centrifuge, ground socket



- Borosilicate glass with precision-ground Quickfit socket to accept tapered stopper
- Conical or cylindrical shape
- Each tube is marked with its weight to the nearest 0.1g to enable tubes of similar weight to be selected from any batch
- Can be centrifuged at RCF values up to 3000

Product Code	Item code: glass stopper to fit	Shape	Joint size	Tube capacity ml	Tube O.D. x length mm	Pack qty.
BC24/C14T	2595/03M	Conical	14/15	10	17 x 115	10
BC24/C24R	2595/06M	Cylindrical	24/20	30	28.5 x 115	10



*Tubes and stoppers should be ordered separately.
Glass stoppers are listed on page*



Tubes, centrifuge, cylindrical type

PYREX®

- Cylindrical type, round base
- Uniform glass distribution in wall and base for improved strength
- Manufactured from chemically resistant Pyrex® glass
- Can be centrifuged at RCF values up to 3000

Product Code	Capacity (ml)	O.D. mm	Length (mm)	Pack qty.
1660/02M	10	16	90	40
1660/06M	25	24	90	40
1660/08M	45	30	90	40



Always examine tubes before use. Do not use if scratched, chipped or abraded.



Tube, centrifuge, pear shape, ASTM

PYREX®

- Complies with ASTM D96 and D-1966
- For the determination of water and sediment in petroleum products
- Graduated in white enamel:
 - Lower stem graduated 0 to 1.5ml in 0.1ml divisions
 - Upper body graduated 1.5 to 5ml in 0.5ml divisions and from 5 to 10ml in 1ml

Product Code	Capacity (ml)	Approx overall length mm	Neck I.D. mm	Pack qty.
3440/02M	100	157	17	2



Tube, centrifuge, conical, ASTM

PYREX®

- Complies with ASTM D96, D91, D-893 and D-1796
- In accordance with standard methods of testing for water and sediment in petroleum products
- Manufactured from chemically resistant Pyrex® borosilicate glass

Product Code	Capacity (ml)	Approx overall length mm	Neck I.D. mm	Pack qty.
3450/02MP	100	200	17	2





Tubes, culture

PYREX®

- Ideal for culture work
- Manufactured from Pyrex® borosilicate glass
- High resistance to attack from water reduces leaching of contaminants which can cause pH changes
- Phenolic screwcaps with inert PTFE lined rubber disc
- Cap can withstand repeated dry heat and steam sterilisation cycles (121°C for 2 hours)

Product Code	O.D. x length mm	Wall thickness mm	Thread size mm	Pack qty.
1636/24MP	14 x 100	1.5	13	40
1636/26MP	16 x 100	1.8	15	40
1636/04MP	16 x 125	1.8	15	40
1636/30MP	16 x 160	1.8	15	40
1636/32MP	18 x 100	1.8	18	40
1636/34MP	18 x 180	1.8	18	40
1636/36MP	20 x 100	1.8	20	40
1636/38MP	20 x 200	1.8	20	40
1636/10MP	22 x 200	1.8	22	40
1636/42MP	26 x 100	2.0	25	40
1636/44MP	26 x 200	2.0	25	40



*Culture tubes are not recommended for centrifuge work.
Do not autoclave with a tightly screwed cap, always slacken off. Failure to adopt this procedure may result in tube breakage.*



Tubes, culture, spares

Product Code	Description	Thread size mm	Pack qty.
4503/13	Cap with insert	13	20
4503/15	Cap with insert	15	20
4503/18	Cap with insert	18	20
4503/20	Cap with insert	20	20
4503/22	Cap with insert	22	20
4503/25	Cap with insert	25	20
4513/13M	Spare insert	13	20
4513/15M	Spare insert	15	20
4513/18M	Spare insert	18	20
4513/20M	Spare insert	20	20
4513/22M	Spare insert	22	20
4513/25M	Spare insert	25	20



Tubes, digestion, with socket



- Designed for use with blockheaters
- With Quickfit® precision-ground socket to accept air condensers etc.
- Manufactured from borosilicate glass for highest chemical and thermal durability

Product Code	Capacity (ml)	Diam. mm	Overall length mm	Joint size	Pack qty.
TJ15/16/1	15	16	145	14/23	5
TJ75/26/3	75	26	255	24/29	5
TJ100/26/3	100	26	300	24/29	5
TJ250/42/6	250	42	300	40/38	5

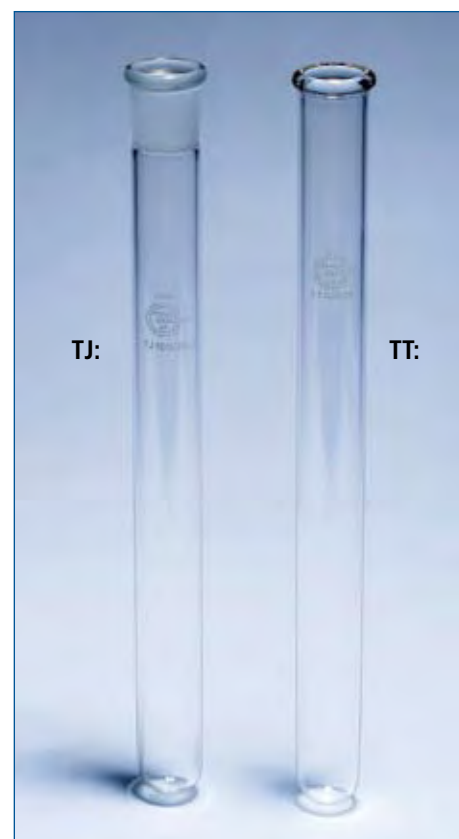

Tubes, digestion, plain

- For use with block heaters
- With plain beaded neck
- Manufactured from borosilicate glass for highest chemical and thermal durability

Product Code	Capacity (ml)	Diam. mm	Overall length mm	Pack qty.
TT100/26	100	26	300	5
TT250/42	250	42	300	5

Tubes, drying, angled



- For use with a desiccant such as calcium chloride
- Ground glass cone to fit Quickfit® apparatus

Product Code	Cone size	Pack qty.
MF23/1	14/23	1
MF23/2	19/26	1
MF23/3	24/29	1
MF23/4	29/32	1





Tubes, drying, 'U' shaped



- For use with desiccants such as calcium chloride
- With two ground sockets to accept Quickfit® stopcock/tubing adapters etc.

Product Code	Socket size	Pack qty.
MF21/2	19/26	1



Filter tubes, plain neck

PYREX®

- For small scale filtrations
- Ideal for use with Pyrex® short stem funnels

Product Code	Length (mm)	Tube O.D. mm	Tube I.D. mm	Sidearm O.D. mm	Pack qty.
2110/06M	150	18	15	6	10
2110/08M	150	24	22	6	10



Gas distribution tubes

PYREX®

- Ideal for the dispersion of gas in liquids
- Borosilicate glass tube with sintered thimble
- Choice of thimble porosities to achieve optimum gas bubble size

Product Code	Porosity grade	O.D. of thimble mm	Nom. overall length mm	Diam. of tube mm	Pack qty.
3830/00M	0	15	300	8	2
3830/02M	1	15	300	8	2
3830/04M	2	15	300	8	2
3830/06M	3	15	300	8	2



Gas delivery tubes, polypropylene



Azlon

- Pre-bent rigid polypropylene delivery tubes
- Unbreakable in normal use - ideal substitutes for fragile glass alternatives
- Suitable for many types of gas collection experiments in schools and universities

Product Code	Key	Type	Tube O.D. mm	Tube I.D. mm	Pack qty.
DT001	A	90 Degree	6	4	5
DT002	B	Bung Top	6	4	5
DT003	C	Side Arm	6	4	5
DT004	D	Straight tube	6	4	5
DT005	E	Double Bend	6	4	5
DT006	F	U Bend	6	4	5
DT007	G	Large U Bend	6	4	5
DT008	H	Small U bend	6	4	5
DT009	I	Test tube side arm	6	4	5
DT001MP	-	Multi pack - One of each shape	6	4	9



It is not recommended that these tubes be exposed to temperatures above 60°C.

Tubes, test, with rim, medium wall

PYREX®

- Conforms to ISO 4142
- High quality test tubes designed and constructed for optimum performance
- Manufactured from Pyrex® borosilicate glass which gives superior performance to neutral borosilicate and soda-lime glass
 - Allows use at temperatures up to 500°C
 - Excellent resistance to chemical attack

Product Code	Approx capacity to rim ml	Dimensions O.D. x length mm	Wall thickness mm	Pack qty.
1620/02M	4	10 x 75	1.0	100
1620/04M	6	12 x 75	1.0	100
1620/06M	8	12 x 100	1.0	100
1620/09M	14	16 x 100	1.2	100
1620/10M	18	16 x 125	1.2	100
1620/12M	22	16 x 150	1.2	100
1620/14M	23	16 x 160	1.2	100
1620/15M	34	18 x 180	1.2	100
1620/16M	28	18 x 150	1.2	100
1620/20M	55	24 x 150	1.2	100
1620/22M	73	24 x 200	1.2	50



For advice on the safe heating of Pyrex® glassware, please refer to the technical information section.



Tubes, test, with rim, heavy wall

PYREX®

- Conforms to ISO 4142
- Test tubes with a heavy wall to provide extra mechanical strength
- Robust construction reduces possibility of breakages:
 - Lower replacement costs
 - Improved user safety
- Pyrex® borosilicate glass for high resistance to thermal shock and chemical attack

Product Code	Approx capacity to rim ml	Dimensions O.D. x length mm	Wall thickness mm	Pack qty.
1624/02M	3	10 x 75	1.5	100
1624/04M	5	12 x 75	1.5	100
1624/06M	6	12 x 100	1.5	100
1624/10M	15	16 x 125	1.8	100
1624/12M	18	16 x 150	1.8	100
1624/16M	24	18 x 150	1.8	100
1624/20M	48	24 x 150	1.8	100



Tubes, test, without rim, medium wall

PYREX®

- Conforms to ISO 4142
- High quality test tubes designed and constructed for optimum performance
- Manufactured from Pyrex® borosilicate glass which gives superior performance to neutral borosilicate and soda-lime glass
- Allows use at high temperatures - up to 500°C
- Ideal for microbiology culture work
- Excellent resistance to chemical attack

Product Code	Approx capacity to rim ml	Dimensions O.D. x length mm	Wall thickness mm	Pack qty.
1622/02M	4	10 x 75	1.0	100
1622/04M	6	12 x 75	1.0	100
1622/06M	8	12 x 100	1.0	100
1622/09M	14	16 x 100	1.2	100
1622/10M	17	16 x 125	1.2	100
1622/12M	22	16 x 150	1.2	100
1622/14M	23	16 x 160	1.2	100
1622/15M	34	18 x 180	1.2	100
1622/16M	28	18 x 150	1.2	100
1622/20M	55	24 x 150	1.2	100
1622/22M	73	24 x 200	1.2	50



For advice on the safe heating of Pyrex® glassware, please refer to the Care and Maintenance section.

PYREX®

Tubes, test, without rim, heavy wall

- Conforms to ISO 4142
- Rimless test tubes with a heavy wall to provide extra mechanical strength
- Robust construction reduces possibility of breakages:
 - Lower replacement costs
 - Improved user safety
- Manufactured from Pyrex® borosilicate glass for high resistance to thermal shock and chemical attack

Product Code	Approx capacity to rim ml	Dimensions O.D. x length mm	Wall thickness mm	Pack qty.
1626/02M	3	10 x 75	1.5	100
1626/04M	5	12 x 75	1.5	100
1626/06M	6	12 x 100	1.5	100
1626/10M	15	16 x 125	1.8	100
1626/12M	18	16 x 150	1.8	100
1626/16M	24	18 x 150	1.8	100
1626/20M	48	24 x 150	1.8	100



Tubes, test, ground socket



- High quality test tubes with a precision-ground Quickfit® socket
- Accepts Quickfit® glass stoppers
- Manufactured from borosilicate glass - excellent resistance to chemical attack and thermal shock
- Tubes and stoppers should be ordered separately

Product Code	Item code: stopper	Socket size	Dimensions O.D. x length mm	Approx capacity ml	Pack qty.
MF24/0/4	SB10	10/19	14 x 100	5	5
MF24/12/4	SB12	12/21	17 x 100	10	5
MF24/1	SB14	14/23	19 x 100	11	5
MF24/1/5	SB14	14/23	19 x 125	15	5
MF24/1/6	SB14	14/23	19 x 150	19	5
MF24/2	SB19	19/26	23 x 100	19	5
MF24/2/6	SB19	19/26	23 x 150	31	5
MF24/3	SB24	24/29	29 x 150	54	5
MF24/3/8	SB24	24/29	29 x 200	75	5
MF24/5	SB34	34/35	41 x 250	195	5



i For glass stoppers, please see page 247.



Tubes, test, ground socket, with stopper

PYREX®

- Pyrex® borosilicate glass with ground socket
- Supplied with interchangeable polyethylene stopper

Product Code	Dimensions O.D. x length mm	Capacity (ml)	Stopper size	Pack qty.
1630/02M	13 x 100	5	10/19	10
1630/06M	18 x 125	10	14/23	10
1630/10M	22 x 150	25	19/26	10
1630/12M	26 x 200	50	24/29	10



Tubes, test, graduated, ground socket, with stopper **PYREX®**

- With white enamel graduations to indicate capacity
- Pyrex® borosilicate glass construction provides excellent resistance to chemical attack and thermal shock
- Supplied with interchangeable polyethylene stopper

Product Code	Capacity (ml)	Dimensions O.D. x length mm	Grads. ml	Stopper size	Pack qty.
1628/06M	5	13 x 100	0.1	10/19	10
1628/10M	10	18 x 125	0.2	14/23	10
1628/18M	25	22 x 150	0.5	19/26	10
1628/22M	50	26 x 200	1.0	24/29	10



For spare polyethylene stoppers, please see page 249.



Tweezers, PMP / POM



- High quality, autoclavable tweezers
- Available with pointed or rounded ends
- Fine tooth grips for secure handling of samples

Product Code	Material	Colour	Ends	Pack qty.
TWY260	PMP	White	Sharp	1
TWY262	PMP	White	Sharp	1
TWY264	POM	Yellow	Round	1
TWY266	POM	Yellow	Round	1



Watch glasses

PYREX®

- For evaporation work and covering heated beakers
- Manufactured from heat resisting Pyrex® borosilicate glass
- Fire-polished edges to reduce chipping and breakage

Product Code	Nom. diam.mm	Pack qty.
1060/04D	40	10
1060/06D	50	10
1060/09D	60	10
1060/10D	80	10
1060/14D	100	10
1060/18D	125	10
1060/20D	150	10
1060/21D	200	10
1060/24D	250	10



Avoid sudden temperature changes which can result in breakage. Always heat and cool gradually.



Water estimators, light entrainers



- Complies with BS 756
- Dean & Stark pattern receivers for the determination of the water content in petroleum products
- For use with solvent entrainers which are lighter than water
- Borosilicate glass with graduated tube
- Receiver WE6/23/10T is fitted with PTFE GP Rotaflo® stopcock for easy drainage

Product Code	Description	Capacity (ml)	Grads. ml	Socket size	Cone size	Pack qty.
WE6/23/2	Receiver	2.0	0.05	19/26	24/29	1
WE6/23/7	Receiver	7.5	0.10	19/26	24/29	1
WE6/23/10T	Receiver with stopcock	10.0	0.10	19/26	24/29	1
WE6/23/25	Receiver	25.0	0.20	19/26	24/29	1



Water Estimators, heavy entrainers



- Complies with BS 756
- For the determination of water content in petroleum products using a solvent entrainer which is heavier than water
- Also suitable for the estimation of volatile oil content
- Highest quality borosilicate glass with graduated tube and Quickfit® precision-ground joints

Product Code	Description	Capacity (ml)	Grads. ml	Socket size	Cone size	Pack qty.
WE7/23/3	Receiver	3.0	0.05	19/26	24/29	1
WE7/23/12	Receiver	12.5	0.1	19/26	24/29	1



Weighing scoop, Glass

PYREX®

- With hollow stem to aid introduction of the powder into narrow neck vessels e.g. volumetric flasks
- The flat base ensures stability on the balance pan

Product Code	Nom. capacity ml	Overall length mm	Pack qty.
2115/02M	3	70	10
2115/04M	6	85	10
2115/06M	10	100	10



Weighing scoop, HDPE



Azlona

- Lightweight HDPE weighing boats
- Good chemical resistance

Product Code	Capacity (ml)	Body dim. mm	Overall length mm	Pack qty.
FWC320	2	33 x 15	40	10
FWC322	10	55 x 24	63	10
FWC324	35	85 x 38	101	10



Weighing bottles



- Complies with DIN 12605
- Chemically inert Pyrex® borosilicate glass
- Lightweight construction with ground glass stoppers
- Choice of squat or tall form bottles

Product Code	Capacity (ml)	Diam. mm	Height mm	Shape	Pack qty.
WB25/40	8	25	40	Tall	1
WB30/50	20	30	50	Tall	1
WB30/60	25	30	60	Tall	1
WB35/30	10	35	30	Squat	1
WB35/70	40	35	70	Tall	1
WB40/80	60	40	80	Tall	1
WB50/30	20	50	30	Squat	1
WB50/80	100	50	80	Tall	1



Weighing bottle supplied complete with ground lid.
WB35/60 and WB50/80 are supplementary to DIN range.

Index by product name

A

Adapters	
cone/screwthread	25
expansion	25
multiple necks	27
Perkin	31
receivers	28 - 31
reduction	26
reduction, PTFE	26
splash head	32, 33
steam distillation head	33
still head	34, 35
stopcock	35, 36
swan neck	28
SVL® cone/screwthread	253
thermometer	266
tubing	36, 37
Ampoule breakers	37
Arsenic determination apparatus	38
Aspirators	
glass	38 - 40
plastic	41, 42
Automatic burettes	82 - 85

B

Baffle flasks	131
Bags, autoclave	43
Balers	43
Basket	44
Beakers, glass	
conical	48
heavy-duty	47
jacketed	48
low form	46, 47
tall form	47
Beakers, plastic	
medicine	204
PMP (TPX)	51
polypropylene	49, 50
PTFE	51
Beta radiation shields	223
Bibbette® pipette filler	215
Bins	
glass disposal	52
incineration	52
Boards, cutting	102
Boiling flasks	127, 128
Bottle carriers	75
Bottles, glass	
amber	55
density	59
Dreschel	187
dropping	60
media-lab	53 - 55
plastic coated	54
reagent	57 - 59
roller	60

square	55
weighing	281

Bottles, plastic	
aspirator	41, 42
carboy	63, 64
dispensing	68
Driplok®	69 - 72
graduated	62, 66, 67
gram staining	71
HDPE	63 - 67
LDPE	67 - 74
narrow neck	61, 63, 64, 67, 73, 74
polypropylene	61 - 63
powder	65
PTFE	69
tracker	72
wash	69 - 74
Boxes	
airtight	75
slide storage	227
sterilising	230
Bubblers	76
Büchner	
flasks	138, 139
funnels	170 - 173

Buckets	
HDPE	77
ice	188
Bulb pipettes	207 - 209
Burettes	
acrylic	85
automatic zero	83 - 85
class AS, works certified	78
class AS	78, 79, 81
class B	79 - 82
modular	81
Rotaflo®	80
Schellbach	79, 81, 84
Sofnol, auto zero	82, 83
stopcocks	240, 242

C

Caps	
bottle	56, 58
culture closures	133
Quickfit®	202
SVL®	252, 253
Carboys	63, 64
Centrifuge tubes	269 - 271
Chemistry sets	225, 226
Chromatography column	86 - 88
Clamps	
burette	88
tubing	88
Claisen	
head	34
flasks	145

Cleaning, Lipsol detergent	89
----------------------------	----

Clips	
conical joints	194
flat flange joints	196
spherical joints	198, 199, 201
Cold trap	89
Condensers	
air	90
Allihn	90
coil	91, 92, 94
cold finger	93
Davies	93
distillation apparatus	95
ether	94
inland revenue	94
jacketed coil	92
Liebig	95
multi-coil	92
twin-coil	92

Cones	
Imhoff sedimentation	189
Quickfit®	190 - 192
Conical beakers	48
Conical flasks	129 - 136

Connectors	
non-return valves	97
screwthread	96
tubing	96, 97
Containers	98 - 100
Crow receiver	108

Crucibles	
adapter	101
Gooch	101
Crystallising dishes	116
Culture tubes	272
Culture flasks	131 - 133, 150
Culture vessels	152
Cutting board	102

Cylinders, glass	
class A, works certified	103
class A	103
class B	104 - 108
heavy-duty	105
plastic foot	106
Nessler	108
stoppered	106, 107
Cylinders, plastic	
class A	110
class B	109 - 111
squat form	109

D

Dean and Stark	280
Delivery tubes	275
Density bottles	59
Desiccators	
cabinet	113

- non-vacuum112
 vacuum 112, 113
 polycarbonate113
 Detergent, Lipsol89
 Developing dishes119
 Digestion tubes273
 Dilatometer114
Dishes
 crystallising116
 evaporating117
 general purpose117
 mortar118
 pestle118
 petri118
 photographic119
 Dispensing bottles
 pivot nozzle68
 Dispensers, tilt measure119
 Disposal bins52
 Distillation flasks137
 Distillation head165
 Draining racks219
 Dreschel bottles 185 - 187
Dropping
 bottles60
 funnels 176 - 180
 pipettes214
 drum42
 Drying tubes273, 274
 Dufton columns164
E
Erlenmeyer flasks
 heavy duty 129, 130
 narrow neck129
 Quickfit® 135, 136
 screwcap133
 wide neck130
 plastic136
 Evaporating dishes117
 Evaporating flasks143
 Expansion adaptors25
Extractors
 glass thimbles122
 liquid-liquid123
 liquid-solid 120, 123
 plain body121
 Soxhlet 120, 123
F
 Fermentation vessels152
 Fernbach flasks132
Filtration
 discs124
 rubber cones102
 flasks 138, 139
 funnels 169 - 175
 Gooch101
 membrane 125, 126
 pump 126, 218
 system126
 tubes274
 Finger/hand protectors187
 Flask stand147
Flasks
 amber volumetric 155, 157
 baffled131
 boiling 127, 128
 Büchner 138, 139
 Claisen145
 conical 129 - 136
 culture 131, 132, 152
 cylindrical131
 distillation137
 Erlenmeyer flasks 129 - 136
 extraction128
 Fernbach132
 filter 138, 139
 flat bottom 127, 142, 143
 Florentine143
 heavy-duty 129, 130
 Iodine140
 jacketed 151, 258
 Kjeldahl 140, 141
 Kohlrausch162
 multi neck 144, 145, 148 - 150
 pear shaped 144, 145
 reaction 151, 257
 rotary evaporator143
 round bottom 146 - 150
 Roux culture150
 volumetric 154 - 162
Flat flange
 flasks 151, 152
 joints196
 seals197
 Flow indicator162
 Forceps279
Fractionation
 column packing163
 column packing support163
 columns 163, 164
 distillation head165
 Dufton164
 plain163
 Vigreux164
Funnels
 Büchner 170 - 173
 dropping 176 - 180
 filter 169 - 175
 general purpose 165 - 167
 industrial167
 membrane filter 125, 126
 powder168
 pressure equalising 179, 180
 separating 181 - 185
 thistle169
 vacuum173
G
 Gallipots98
Gas
 bubblers76
 delivery tubes275
 distribution tubes274
 wash bottles 185 - 187
 Gooch crucibles101
 Graduated pipettes 209 - 213
 Gram staining kit71
H
 Hand/finger protectors187
Heavy-duty
 beakers47
 cylinders105
 flasks 129, 130
 Hand pumps217
I
 Ice bucket188
 Imhoff sedimentation cone189
 Incineration bins52
 Inland revenue condensers94
 Instrument tray266
 Integral washbottle74
 Iodine flasks140
J
Jacketed
 beakers48
 condensers92
 flasks 151, 258
 Jerrycans190
Joint clips
 conical194
 flat flange196
 spherical 198, 199
Joints
 cones 190 - 192
 flat flange196
 Rotulex®200
 screwthread201, 202
 sockets192
 sleeves, PTFE193
 spherical 197 -201
 SVL®251
 Torion254, 255
Jugs
 polypropylene203
K
Keys, stopcock
 glass243
 GP Rotaflo®241

Index by product name

- HP Rotaflo® 239
PTFE 243
Kipps measure 119
Kits
 organic chemistry 225, 226
 slide staining 227
Kjeldahl flasks 140, 141
Kohrausch flasks 162
- L**
- Liebig condenser 95
Liquid-liquid extractors 123
Liquid-solid 120 - 123
Lunge-Rey pipette 214
- M**
- Magnetic stirrer bars 230 - 233
Magnetic retrievers 233
Markham still 205
Medicine measures 204
Measuring cylinders 103 - 111
Measuring scoops 224
Media-lab bottles 53 - 55
Membrane filters 125, 126
Mercury collector 204
Microscope slide staining kit 227
Microscope slide staining jar 227
Mixing cylinders 106, 107
- N**
- Nessler cylinders 108
Nitrogen determination
 distillation unit 205
 Kjeldahl assembly 205
 Kjeldahl flasks 140, 141
 Markham Still 205
Non-return valves 97
- O**
- One-mark pipettes 207, 208
Organic chemistry kit 225, 226
- P**
- Petri dishes, glass 118
Petri dishes, stand 229
Perkin adapter 31
Pear shaped flasks 144 - 145
Photographic dish 119
Pipette fillers
 Bibbette® 215
 rubber 215
Pipette rack 216
Pipette rinsing 222
Pipette stand 216
Pipette sterilising box 230
Pipette support 216
Pipettes
 class AS, works certified 207, 209, 211
 class AS 207, 209 - 211
 class B 208, 210, 212, 213
 dropping 214
 graduated 209 - 213
 one-mark 207, 208
 serological 213
 two-mark 209
 weighing, Lunge Rey 214
Pneumatic troughs 267
Pouring rings for media-lab bottles 56, 57
Powder funnels 168
Precision thermometers 264
Pressure equalising funnels 179, 180
PTFE
 beakers 51
 bottles 69
 joint sleeves 193
 magnetic stirring bars 230 - 233
 seals 197
Pumps
 barrel 217
 filter 126
 general purpose 217
 water jet 218
- Q**
- Quickfit® sets 225, 226
- R**
- Racks**
 draining 219
 microcentrifuge 221
 test tube 220
Radiation shields 223
Raschig rings 163
Reaction flasks 151, 257, 258
Receivers 28 - 31, 108
Reduction adapters 26
Reaction bubblers 76
Reagent bottles 57 - 59
Retaining clips 153
Retort stand 229
Retrievers, magnetic 233
Rinsing system, pipette 222
Rods, stirring 237
Roller bottles 60
Rotaflo®
 adapters 35, 36
 burettes 80, 82
 dropping funnels 177, 179
 separating funnels 182, 183
 stopcocks 35, 36, 39, 238 - 241
Rotary evaporator flasks 143
Rotary evaporator splash heads 33
Rotulex® joints 200, 201
Roux culture flasks 150
Rubber cones 102
- S**
- Safety**
 beta radiation 223
 shields 223
 hand/finger protectors 187
Scoops
 plastic 224
 weighing 281
Screw caps
 bottle 56, 58
 Quickfit® 202
 SVL® 253
screw thread adapters 96
Sedimentation cone 189
Semi-micro filter receivers 175
Separating funnels 181 - 185
Serological pipettes 213
Sets 225, 226
Shields, beta radiation 223
Shield, safety 223
Sintered discs 124
Siphon pumps 126, 217, 218
Sleeves, joint 193
Slide staining jar 227
Slide staining kit 227
Sockets 192
Sofnol burettes 82, 83
Solvent still heads 35
Soxhlet extractors 120, 123
Spatulas, polypropylene 228
Specimen containers 100
Spherical joints 197 - 201
Splash head adapters 32, 33
Spotting tile 228
Stand, petri dish 229
Stand, retort 229
Sterilising boxes 230
Sterilising trough 267
Still heads 34, 35
Stirrers
 bars, magnetic 230 - 233
 bearings 256
 blades 234
 glands 236
 guides 235
 heads 256
 rods 237
 shafts 234, 235, 255
Stopcocks
 aspirator 39 - 41
 burette repair 240, 242
 funnel repair 242
 glass key 243 - 245
 high vacuum 244, 245
 plastic 246, 247
 PTFE 241 - 243
 Rotaflo® 238 - 241
 SVL® Torion 261

Stoppers	
glass	247 - 249
plastic	249
SVL® glassware	250 - 261
Swan neck adapter	28
T	
Test tube basket	44
Test tube rack	220
Test tubes	275 - 278
Thermometers	
adapter	266
Bee-ka	264
general purpose	262, 263
pocket	266
precision	264
Quickfit®	265
Thistle funnel	169
Tile, spotting	228
Tongue depressors	228
Thorpe condenser	95
Tilt measure dispensers	119
Traps, cold	93
Torion joints	254, 255
Trays	266
Troughs	267
Tubes	
air/steam inlet	268
centrifuge	269 - 271
culture	272
digestion	273
drying	273, 274
test	275 - 278
Tubing	
adapters	35 - 37
clamps	88
Tweezers	279
Two-mark pipettes	209
V	
Vacuum	
desiccators	112, 113
flask	136, 138, 139
pump	126, 218
stopcocks	238, 239, 244, 245
Valve, non-return	97
Vigreux	
column	164
flasks	145
Volumetric flasks	154 - 162
W	
Wall mountable draining rack	219
Wash bottles	
coloured	74
custom DIY	70, 71
DripLok® venting	69 - 72
gas	185 - 187
general LDPE	69 - 74
gram staining	71
tracker	72
Waste bins	
broken glass	52
incineration	52
Watch glasses	279
Water jet pump	126, 218
Water Estimators	280
Weighing	
bottles	281
scoop	281
pipette	214

Index by item code

1

10/050/10	263	1080/02M	127	1137/12M	133	1480/02D	118
1000/02M	46	1080/04M	127	1137/13M	133	1480/06D	118
1000/03M	46	1080/08D	127	1137/14M	133	1480/08D	118
1000/04D	46	1080/10D	127	1137/18M	133	1480/10D	118
1000/05M	46	1080/12D	127	1138/10	132	1480/12D	118
1000/06D	46	1080/14D	127	1139/10	132	1490/02	117
1000/10D	46	1100/02M	128	1140/02M	130	1490/04	117
1000/11M	46	1100/04M	128	1140/04D	130	1490/06	117
1000/14D	46	1100/12D	128	1140/08D	130	1490/08	117
1000/18D	46	1100/18D	128	1140/10D	130	1515/01D	57
1000/20D	46	1100/24D	128	1140/14D	130	1515/02D	57
1000/22D	46	1100/28D	128	1140/18D	130	1515/04D	57
1000/28D	46	1100/32D	128	1170/02M	138	1515/06D	57
1000/30D	46	1100/35D	128	1170/02SC	138	1515/08D	57
1000/34D	46	1100/36D	128	1170/04M	138	1515/10D	57
1000/38D	46	1100/38D	128	1170/04SC	138	1515/12D	57
1003-150	47	1120/04M	128	1170/06M	138	1515/16D	57
1003-1L	47	1120/08D	128	1170/06SC	138	1515/18D	57
1003-250	47	1120/14D	128	1170/08M	138	1515/20D	57
1003-2L	47	1120/18D	128	1170/08SC	138	1515/22D	57
1003-3L	47	1120/22D	128	1170/10D	138	1516/01D	53
1003-400	47	1120/26D	128	1170/10SC	138	1516/01Red	53
1003-4L	47	1120/29D	128	1170/12M	138	1516/02D	53
1003-5L	47	1130/02M	129	1170/14D	138	1516/02Red	53
1003-600	47	1130/03	129	1170/14SC	138	1516/04D	53
100RASX	123	1130/05M	129	1190/02M	131	1516/04Red	53
1015/02M	47	1130/06D	129	1190/04M	131	1516/06D	53
1015/04D	47	1130/10D	129	1190/06M	131	1516/06Red	53
1015/06D	47	1130/11M	129	1200/04M	140	1516/08D	53
1015/10D	47	1130/12D	129	1200/10D	140	1516/08Red	53
1015/14D	47	1130/14D	129	1200/12D	140	1516/10D	53
1015/18D	47	1130/16D	129	1200/16M	140	1516/10Red	53
1015/22D	47	1130/20D	129	1280/14M	137	1516/12D	53
1015/26D	47	1130/26D	129	1290/04M	137	1516/12Red	53
1020/06D	48	1130/30D	129	1290/06M	137	1516/16D	53
1020/16D	48	1130/32D	129	1350/04M	150	1516/18D	53
1025/10SC	48	1130/36D	129	1350/06M	150	1516/20D	53
1025/18SC	48	1132/02	134	1450/01D	117	1516/22D	53
1025/22SC	48	1132/06	134	1450/03D	117	1517/01	54
1025/28SC	48	1132/14	134	1450/04D	117	1517/02	54
1060/04D	279	1132/20	134	1450/06D	117	1517/04	54
1060/06D	279	1132/26	134	1450/10D	117	1517/06	54
1060/09D	279	1133/02	134	1450/14D	117	1517/08	54
1060/10D	279	1133/06	134	1470/00M	116	1517/10	54
1060/14D	279	1133/14	134	1470/01M	116	1517/12	54
1060/18D	279	1133/20	134	1470/02D	116	1517/16	54
1060/20D	279	1133/26	134	1470/03M	116	1517/18	54
1060/21D	279	1134/08	131	1470/04D	116	1517/20	54
1060/24D	279	1134/10	131	1470/08D	116	1517/22	54
1070/02M	127	1134/12	131	1470/10D	116	1518/04	54
1070/04D	127	1134/14	131	1470/12D	116	1518/06	54
1070/12D	127	1135/14D	132	1470/16D	116	1518/08	54
1070/18D	127	1135/20D	132	1471/00M	116	1518/10	54
1070/24D	127	1135/26D	132	1471/01M	116	1518/12	54
1070/28D	127	1135/30D	132	1471/02M	116	1518/16	54
1070/32D	127	1137/02M	133	1471/03M	116	1518/18	54
1070/36D	127	1137/03D	133	1471/04M	116	1519/01	55
1070/38D	127	1137/06M	133	1471/08M	116	1519/02	55
1070/40D	127	1137/08D	133	1471/10M	116	1519/04	55
1070/42D	127	1137/10M	133	1471/12M	116	1519/06	55
		1137/11M	133	1471/16M	116	1519/08	55

Index by item code

3151/04	156	3201/10	103	3299/06	82, 83	3722/04M	172
3151/04WC	154	3201/10WC	103	3396/02AS	84	3722/06M	172
3151/06	156	3201/12	103	3396/04AS	84	3722/08M	172
3151/06WC	154	3201/12WC	103	3396/06AS	84	3730/04	169
3151/08	156	3201/14	103	3400/04	108	3730/06	169
3151/08WC	154	3201/14WC	103	3440/02M	271	3730/08	169
3151/10	156	3201/16	103	3450/02MP	271	3750/03	169
3151/10WC	154	3201/16WC	103	3460/02M	269	3760/02	170
3151/12	156	3201/18	103	3496/02AS	84	3760/04	170
3151/12WC	154	3201/18WC	103	3496/04AS	84	3760/06	170
3151/14	156	3205/04MP	106	3496/06AS	84	3770/02	170
3151/14WC	154	3205/06MP	106	3590/01	178	3770/04	170
3151/16	156	3205/08P	106	3590/02	178	3770/06	170
3151/16WC	154	3205/10P	106	3590/04	178	3770/08	170
3151/18	156	3205/12P	106	3590/06	178	3770/10	170
3151/18WC	154	3211/04MP	107	3590/08	178	3775/02M	86
3151/20	156	3211/06MP	107	3620/02	171	3780/02M	170
3151/20WC	154	3211/08MP	107	3620/04	171	3780/04M	170
3151/22	156	3211/10MP	107	3620/06	171	3780/06M	170
3151/22WC	154	3211/12MP	107	3620/08	171	3830/00M	274
3151/24	156	3211/14MP	107	3620/10	171	3830/02M	274
3151/24WC	154	3211/16MP	107	3630/01	171	3830/04M	274
3151/26	156	3211/18MP	107	3630/02	171	3830/06M	274
3151/26WC	154	3215/06MP	106	3630/04	171	3840/02M	122
3152/04A	157	3215/08P	106	3630/06	171	3845/02M	122
3152/04AWC	155	3215/10P	106	3630/08	171		
3152/06A	157	3215/12P	106	3630/10	171		
3152/06AWC	155	3280-100	105	3650/02M	101	40023	89
3152/08A	157	3280-1L	105	3650/04M	101	40/101/02	264
3152/08AWC	155	3280-250	105	3650/06M	101	40RASX	123
3152/10A	157	3280-2L	105	3650/08M	101	443038N	182
3152/10AWC	155	3280-50	105	3660/02M	101	443042N	182
3152/12A	157	3280-500	105	3660/04M	101	443047N	182
3152/12AWC	155	3285-10	105	3660/06M	101	443054N	182
3152/14A	157	3285-100	105	3660/08M	101	443060N	182
3152/14AWC	155	3285-1L	105	3660/10M	101	443065N	182
3152/16A	157	3285-25	105	3680/02M	101	443073N	182
3152/16AWC	155	3285-250	105	3680/04M	101	443333	176
3152/18A	157	3285-50	105	3680/06M	101	443334	178
3152/18AWC	155	3285-500	105	3680/08M	101	443340	176
3152/20A	157	3295/02	79	3680/10M	101	443341	178
3152/20AWC	155	3295/04	79	3690/02M	101	443347	176
3152/22A	157	3295/06	79	3690/04M	101	443348	178
3152/22AWC	155	3295/08	79	3690/08M	101	443354	176
3200/02MP	104	3295/12AS	78	3700/01	171	443355	178
3200/04MP	104	3295/14AS	78	3700/02	171	443360	176
3200/06MP	104	3295/16AS	78	3700/04	171	443361	178
3200/08MP	104	3295/18AS	78	3700/06	171	443533	180
3200/10MP	104	3295/22ASWC	78	3700/08	171	443534	180
3200/12MP	104	3295/24ASWC	78	3700/10	171	443540	180
3200/14MP	104	3295/26ASWC	78	3710/01	172	443541	180
3200/16MP	104	3295/28ASWC	78	3710/02	172	443547	180
3200/18MP	104	3296/02AS	83	3710/04	172	443548	180
3201/02	103	3296/04AS	83	3710/06	172	443554	180
3201/02WC	103	3296/06AS	83	3710/08	172	443555	180
3201/04	103	3297/12	85	3710/10	172	443560	180
3201/04WC	103	3297/14AS	85	3720/02M	172	443561	180
3201/06	103	3298/02	82	3720/04M	172	4500/00	106
3201/06WC	103	3298/03	82	3720/06M	172	4500/01	106
3201/08	103	3298/04	82	3720/08M	172	4500/02M	106
3201/08WC	103	3299/04	82, 83	3722/02M	172	4500/04M	106

4

CON0006A.....	102	CRC322.....	108			DA45.....	26
CP0010P.....	110	CRF530.....	189			DA47.....	26
CP0025P.....	110	CT0010P.....	111	D1/00.....	179	DA5/100.....	120, 152
CP0050P.....	110	CT0025P.....	111	D1/11.....	179	DA5/75.....	120, 152
CP0100P.....	110	CT0050P.....	111	D1/11GP.....	177	DA56.....	26
CP0250P.....	110	CT0100P.....	111	D1/21.....	179	DA57.....	26
CP0500P.....	110	CT0250P.....	111	D1/21GP.....	177	DA58.....	26
CP1000P.....	110	CT0500P.....	111	D1/22.....	179	DBG001P.....	52
CP2000P.....	110	CT1000P.....	111	D1/22GP.....	177	DBG002P.....	52
CPB0010P.....	109	CT2000P.....	111	D1/32.....	179	DBH001P.....	52
CPB0025P.....	109	CTA0010P.....	110	D1/32GP.....	177	DBH002P.....	52
CPB0050P.....	109	CTA0025P.....	110	D1/42.....	179	DE100/22.....	179
CPB0100P.....	109	CTA0050P.....	110	D1/42GP.....	177	DE100/32.....	179
CPB0250P.....	109	CTA0100P.....	110	D1/62.....	179	DE250/32.....	179
CPB0500P.....	109	CTA0250P.....	110	D1/62GP.....	177	DE250/33.....	179
CPB1000P.....	109	CTA0500P.....	110	D2/01.....	185	DE250/44.....	179
CPB2000P.....	109	CTA1000P.....	110	D2/11.....	185	DE250/55.....	179
CPS0100P.....	109	CTA2000P.....	110	D2/11GP.....	183	DT001.....	275
CPS0250P.....	109	CTB0010P.....	111	D2/12.....	185	DT001MP.....	275
CPS0500P.....	109	CTB0025P.....	111	D2/21.....	185	DT002.....	275
CPS1000P.....	109	CTB0050P.....	111	D2/21GP.....	183	DT003.....	275
CR10/10.....	86	CTB0100P.....	111	D2/22.....	185	DT003.....	275
CR10/20.....	86	CTB0250P.....	111	D2/22GP.....	183	DT004.....	275
CR10/30.....	86	CTB0500P.....	111	D2/31.....	185	DT005.....	275
CR10/40.....	86	CTB1000P.....	111	D2/31GP.....	183	DT006.....	275
CR12/10.....	87	CTB2000P.....	111	D2/32.....	185	DT007.....	275
CR12/30.....	87	CWH002.....	88	D2/32GP.....	183	DT008.....	275
CR20/20.....	86	CWH004.....	88	D2/42.....	185	DT009.....	275
CR20/30.....	86	CWH204.....	96	D2/42GP.....	183	DWA205.....	113
CR20/40.....	86	CWH206.....	96	D2/43.....	185	DWA215.....	113
CR20/50.....	86	CWH208.....	96	D2/43GP.....	183	DWA236.....	113
CR30/40.....	86	CWH210.....	96	D2/62.....	185	DWA245.....	113
CR30/50.....	86	CWH304.....	97	D2/62GP.....	183	DWA246.....	113
CR32/20.....	87	CWH306.....	97	D24/1L.....	182	DWA301.....	113
CR32/30.....	87	CWH308.....	97	D3/12.....	177	DWA510.....	113
CR32/40.....	87	CWH310.....	97	D3/22.....	177	DWR006.....	119
CR3T/23.....	88	CWH600.....	97	D3/32.....	177	DWR007.....	119
CR40/40.....	86	CWH602.....	97	D31/1/50.....	177	DWR008.....	119
CR40/50.....	86	CWH604.....	97	D52/100.....	182	DWR010.....	119
CR50/40.....	86	CWH606.....	97	D52/250.....	182	DWR012.....	119
CR50/50.....	86	CWH608.....	97	D52/50.....	182		
CR60/40.....	86	CWH610.....	97	D53/500.....	182		
CR60/50.....	86	CX3/05/SC.....	91	D62/50GP.....	205		
CRC201.....	104	CX3/06/SC.....	91	D91/100.....	183		
CRC202.....	104	CX3/08/SC.....	91	D92/100.....	183	EX10/20.....	123
CRC204.....	104	CX3/23/SC.....	91	D93/250.....	183	EX10/23.....	123
CRC206.....	104	CX3/35/SC.....	91	D93/500.....	183	EX13/12.....	163
CRC209.....	104	CX5/23/SC.....	93	DA01.....	26	EX13/23.....	163
CRC211.....	104	CX5/25/SC.....	93	DA01.....	26	EX13/25.....	121, 163
CRC213.....	104	CX6/05/SC.....	92	DA1/22.....	95	EX13/26.....	121, 163
CRC214.....	104	CX6/22/SC.....	92	DA12.....	26	EX5/105.....	120
CRC216.....	104	CX6/33/SC.....	92	DA13.....	26	EX5/21.....	120
CRC302.....	107	CX6/44/SC.....	92	DA14.....	26	EX5/32.....	120
CRC304.....	107	CX7/02/SC.....	90	DA23.....	26	EX5/43.....	120
CRC306.....	107	CX7/03/SC.....	90	DA24.....	26	EX5/53.....	120
CRC308.....	107	CX7/04/SC.....	90	DA25.....	26	EX5/55.....	120
CRC310.....	107	CX7/05/SC.....	90	DA34.....	26	EX5/55/100.....	120
CRC312.....	107	CX7/06/SC.....	90	DA35.....	26	EX5/63.....	120
CRC314.....	107	CX7/08/SC.....	90	DA36.....	26	EX5/75.....	120
CRC316.....	107	CX7/33/SC.....	90	DA37.....	26	EX5/83.....	120
CRC320.....	108	CX7/44/SC.....	90	DA38.....	26	EX7/13.....	121
				DA39.....	26	EX7/33.....	121
				DA4/100.....	152		

FR500/3S/22P	150	FST231	181	GC14.....	194	JPB0250P	203
FR500/3S/2A.....	148	FST242	181	GC19.....	194	JPB0500P	203
FR500/3U	148	FST252	181	GC24.....	194	JPB1000P	203
FR500/4S	147	FST274	181	GC29.....	194	JPB2000P	203
FR500/4S/22A.....	149	FST276	181	GC34.....	194	JPB3000P	203
FR500/4S/22P	150	FST311	181	GC40.....	194	JPB5000P	203
FR500/5S	147	FST321	181	GC45.....	194	JPM0050P	203
FR500F	151	FST331	181	GP10K.....	241	JPM0100P	203
FR5L/4S	147	FST342	181	GP10RA/10.....	240	JPM0250P	203
FR5L/5US.....	147	FST352	181	GP10ST/10.....	240	JPM0500P	203
FR5L/5US/33P.....	150	FST374	181	GP3BU/5B.....	240	JPM1000P	203
FR5L/8S	147	FST511	176	GP3K.....	241	JPM2000P	203
FR5LF	151	FST521	176	GP3RA/5.....	240	JPM3000P	203
FR6L/7S	147	FST531	176	GP3ST/5.....	240	JPM5000P	203
FR6L/7S/44P	150	FST542	176	GP6/10W.....	40	JRV1L	151
FR6LF	151	FST552	176	GP6K.....	241	JRV2L	151
FR700F	151	FV10L.....	152	GP6RA/7.....	240	JWHO125P.....	99
FRD022P.....	159	FV1L.....	152	GP6ST/7.....	240	JWHO250P.....	99
FRD024P.....	159	FV20L.....	152	GWY520.....	98	JWH0500P.....	99
FRD025P.....	159	FV2L.....	152	GWY524.....	98	JWH1000P.....	99
FRD026P.....	159	FV500.....	152	GWY526.....	98	JWH2000P.....	99
FRD028P.....	159	FV5L.....	152	GWY528.....	98	JWH2500P.....	99
FRD030P.....	159	FWC014	166	GWY530.....	98	JWH5000P.....	99
FRD032P.....	159	FWC052	167			JWP0030P	99
FRD034P.....	159	FWC054	167	H		JWP0060P	99
FRD036P.....	159	FWC056	167	Helix-6 blades	256	JWP0125P	99
FRD038P.....	159	FWC058	167	HP10K	239	JWP0250P	99
FRD040P.....	159	FWC060	167	HP10RA/10.....	239	JWP0500P	99
FRD042P.....	159	FWC062	167	HP10ST/10.....	238	JWP0950P	99
FRD164	158	FWC064	167	HP3K	239	JWP1200P	99
FRD166	158	FWC066	167	HP3RA/5.....	239		
FRD167	158	FWC102	167	HP3RA/7.....	239	K	
FRD168	158	FWC104	167	HP3ST/5.....	238	KC10	194
FRD170	158	FWC106	167	HP3ST/7.....	238	KC12	194
FRD172	158	FWC108	167	HP3TW/5	239	KC14	194
FRD174	158	FWC110	167	HP6K	239	KC19	194
FRD176	158	FWC112	167	HP6RA/10.....	239	KC24	194
FRD178	158	FWC114	167	HP6RA/7.....	239	KC29	194
FRD180	158	FWC116	167	HP6ST/10.....	238	KC34	194
FRD182	158	FWC118	167	HP6ST/7.....	238	KC40	194
FRD184	158	FWC202	168	HP6TW/7	239	KC45	194
FRD200	160	FWC204	168			KS13.....	199
FRD202	160	FWC206	168	I		KS19.....	199
FRD204	160	FWC208	168	IBB001P.....	188	KS29.....	199
FRD206	160	FWC210	168	IBB002P.....	188	KS35.....	199
FRD208	160	FWC212	168	IBB003P.....	188	KT10.....	88
FRD210	160	FWC214	168	IBB004P.....	188	KT14.....	88
FRD212	160	FWC220	169			KT4.5.....	88
FRD214	160	FWC320	281	J		KT6.....	88
FRD216	160	FWC322	281	JC100F	120, 153, 196		
FRD218	160	FWC324	281	JC13	198	L	
FRD220	160	FWY053.....	162	JC19	198	LR10.....	239, 241
FRD222	160			JC29.....	196, 198	LR3.....	239, 241
FRE011	162	G		JC35	198	LR6.....	239, 241
FRE013	162	GB1/19.....	76	JC41	196, 198		
FRF442	126	GB1/24.....	76	JC50F	196	M	
FS13UB.....	198	GB1/29.....	76	JC51	196, 198	MA1/11	27
FS19UB.....	198	GB2/19SC.....	76	JC75F	120, 153, 196	MA1/2	27
FS29UB.....	198	GB2/24SC.....	76	JGH140.....	190	MA1/3	27
FS35UB.....	198	GB2/29SC.....	76	JGH148.....	190	MA1/33	27
FS41UB.....	198	GB3/SC.....	76	JGH150.....	190	MA1/44	27
FST211	181	GC10.....	194	JGH154.....	190	MA2/2	27
FST221	181	GC12.....	194	JPB0050P	203	MA2/3	27
				JPB0100P	203	MA4/23	27

Index by item code

MA6/22.....	28	MF24/2/6.....	277	PFL004.....	215	PRA812AS.....	211
MA6/33.....	28	MF24/3.....	277	PFL006.....	215	PRA814AS.....	211
MAF1/75.....	152	MF24/3/8.....	277	PGR402.....	187	PRA816AS.....	211
MAF2/2.....	152	MF24/5.....	277	PGR404.....	187	PRA818AS.....	211
MAF2/32.....	152	MF27/3/13.....	186	PGR406.....	187	PRA820ASWC.....	211
MAF2/41.....	152	MF28/3/125/SC.....	185	PRA620AS.....	209	PRA822ASWC.....	211
MAF2/52.....	152	MF28/3/250/SC.....	185	PRA622AS.....	209	PRA824ASWC.....	211
MAF3/52.....	152	MF28/3/500/SC.....	185	PRA624AS.....	209	PRA826ASWC.....	211
MAF4/41.....	152	MF28/52.....	89	PRA626AS.....	209	PRA828ASWC.....	211
MAF5/2.....	152	MF29/3/125.....	187	PRA630AS.....	209	PRA830B.....	212
MC1/F19/SC.....	205	MF29/3/250.....	187	PRA632AS.....	209	PRA832B.....	212
MC46/SC.....	205	MF29/3/500.....	187	PRA634AS.....	209	PRA834B.....	212
MD2/50.....	145	MF31/0/110.....	265	PRA636AS.....	209	PRA836B.....	212
MD4/100.....	145	MF31/0/250.....	265	PRA700B.....	208	PRA838B.....	212
MD4/50.....	145	MF31/0/360.....	265	PRA702B.....	208	PRA840S.....	213
MD60.....	175	MF31/1.....	265	PRA704B.....	208	PRA842S.....	213
MD61.....	175	MF31/2.....	265	PRA706B.....	208	PRA844S.....	213
MF10/1B/SC.....	36	MF31/2S.....	265	PRA708B.....	208	PRA846S.....	213
MF10/2B/SC.....	36	MF31/3.....	265	PRA710B.....	208	PRA848S.....	213
MF10/3B/SC.....	36	MF48/03/125.....	186	PRA712B.....	208	PS100.....	153, 197
MF10/4B/SC.....	36	MF48/03/250.....	186	PRA714B.....	208	PS75.....	153, 197
MF10/5B/SC.....	36	MF48/03/500.....	186	PRA716B.....	208	PWD003.....	218
MF11/1/SC.....	35	MF48/13/125.....	186	PRA720AS.....	207	PWJ003.....	217
MF11/1B/SC.....	36	MF48/13/250.....	186	PRA722AS.....	207	PWJ004.....	217
MF11/2/SC.....	35	MF48/13/500.....	186	PRA724AS.....	207	PWJ014.....	217
MF11/2B/SC.....	36	MF48/23/250.....	186	PRA726AS.....	207	PWJ016.....	217
MF11/3/SC.....	35	MF48/23/500.....	186	PRA728AS.....	207	PWJ018.....	217
MF11/3B/SC.....	36	MF48/33/250.....	186	PRA730AS.....	207	PWJ020.....	218
MF11/4/SC.....	35	MF5.....	268	PRA732AS.....	207	PWJ021.....	218
MF13/2/SC.....	37	MS13UB.....	197	PRA734AS.....	207	PWP050.....	230
MF13/3/SC.....	37	MS19UB.....	197	PRA736AS.....	207	PWY144.....	215
MF13/4/SC.....	37	MS29UB.....	197	PRA740ASWC.....	207	PWY145.....	215
MF14/1/SC.....	36	MS35UB.....	197	PRA742ASWC.....	207	PWY146.....	215
MF14/2/SC.....	36	MS41UB.....	197	PRA744ASWC.....	207		
MF14/3/SC.....	36	MWY514.....	204	PRA746ASWC.....	207		
MF15/1.....	192, 268	MWY518.....	204	PRA748ASWC.....	207	Q	
MF15/1B/SC.....	269	MWY850.....	204	PRA750ASWC.....	207	QC13/7.....	202
MF15/2.....	192, 268	MWY851.....	204	PRA752ASWC.....	207	QC18/11.....	202
MF15/2B/SC.....	269			PRA754ASWC.....	207	QC24/12.....	202
MF15/3.....	192, 268			PRA754ASWC.....	207	QC28/13.....	202
MF15/3B/SC.....	269			PRA756ASWC.....	207	QC28/21.....	202
MF17/1/SC.....	37	N		PRA760B.....	210	QC28/9.....	202
MF17/2/SC.....	37	NB1203.....	110	PRA762B.....	210	QR13/6.....	202
MF17/3/SC.....	37	NWH902P.....	97	PRA764B.....	210	QR18/7.....	202
MF18/2/SC.....	37	NWH904P.....	97	PRA766B.....	210	QR24/11.....	202
MF18/3/SC.....	37	NWH906P.....	97	PRA768B.....	210	QR24/6.....	202
MF18/33/SC.....	37			PRA770AS.....	210	QR24/9.....	202
MF18/4/SC.....	37			PRA772AS.....	210	QR28/11.....	202
MF18/44/SC.....	37			PRA774AS.....	210	QR28/18.....	202
MF18/5/SC.....	37			PRA776AS.....	210	QR28/6.....	202
MF21/2.....	274			PRA778AS.....	210	QW13/6.....	202
MF23/1.....	273			PRA780ASWC.....	209	QW18/7.....	202
MF23/2.....	273			PRA782ASWC.....	209	QW24/11.....	202
MF23/3.....	273			PRA784ASWC.....	209	QW24/6.....	202
MF23/4.....	273			PRA786ASWC.....	209	QW24/9.....	202
MF24/0/4.....	277			PRA788ASWC.....	209	QW28/11.....	202
MF24/1.....	277			PRA800B.....	212	QW28/18.....	202
MF24/1/5.....	277			PRA802B.....	212	QW28/6.....	202
MF24/1/6.....	277			PRA804B.....	212		
MF24/12/4.....	277			PRA806B.....	212		
MF24/2.....	277			PRA808B.....	212		
				PRA810AS.....	211		
						R	
						RA1/01.....	28
						RA1/02.....	28
						RA1/03.....	28

RA1/04	28	RPB001P	221	SH17/23	32	SST102	241
RA1/10	28	RPB013P	220	SH2/22	35	SST102K	243
RA1/11	28	RPB018P	220	SH2/33	35	SST103	241
RA1/12	28	RPB021P	220	SH30/42/SC	165	SST103K	243
RA1/13	28	RPB026P	220	SH4/0	34	SST104	241
RA1/14	28	RPB031P	220	SH4/1	34	SST104K	243
RA1/22	28	RPR001P	221	SH4/2	34	SST106	241
RA1/23	28	RPW001P	221	SH4/22	34	SST106K	243
RA11/SC	31	RPW013P	220	SH4/23	34	SST108	241
RA12/2	31	RPW018P	220	SH4/24	34	SST203	241
RA13/33/SC	30	RPW021P	220	SH4/33	34	SST203K	243
RA2/11	29	RPW026P	220	SH4/44	34	SST3025	242
RA2/22	29	RPW031P	220	SH4/55	34	SST303K	243
RA2/23	29	RPY001P	221	SH4A	266	SST304	242
RA2/33	29	RWK030	220	SH6/1	34	SST304K	243
RA3/11/SC	30	RWK058	221	SH6/22	34	SST502	242
RA3/22/SC	30	RWK070	219	SH6/23	34	SST702	242
RA3/23/SC	30	RWK070FS	219	SH6/33	34	SST703	242
RA3/33/SC	30			SH6/44	34	SST704	242
RA3/44/SC	30			SH7/0/44	32	SST706	242
RA4/11	29	S/31516/16D	53	SH7/02	32	SSV103	244
RA4/22	29	S/31516/18D	53	SH7/03	32	SSV104	244
RA4/23	29	S/3L5895	131	SH7/12	32	SSV106	244
RA5/11/SC	30	SB10	247	SH7/13	32	SSV202	244
RA5/21/SC	30	SB12	247	SH7/23/SC	33	SSV203	244
RA6/11/SC	31	SB14	247	SH7/43	32	SSV204	244
RA6/22/SC	31	SB14DL	114	SH7/53	32	SSV304	244
RA6/23/SC	31	SB19	247	SH9/1L	35	SSV504	245
RA6/33/SC	31	SB24	247	SH9/250	35	SSV802	245
RA9/11	29	SB29	247	SH9/500	35	SSV804	245
RA9/22	29	SB34	247	SIB24	140	ST1/2	235
RA9/23	29	SB40	247	SIB29	140	ST1/5	234
RA9/33	29	SB45	247	SQ13UB	201	ST1/6	234
RA9/44	29	SB55	247	SQ18UB	201	ST1/8	234
RC13	201	SB7	247	SQ24UB	201	ST11/5	234
RC19	201	SCBNP01	41	SQ28UB	201	ST2/2/SC	235
RC29	201	SF3A32	173	SRB10UB	192	ST2/33C/SC	235
RC35	201	SF3A33	173	SRB12UB	192	ST2/44C/SC	235
RC41	201	SF3A34	173	SRB14UB	192	ST20/2	236
RC64	201	SF3B33	173	SRB19UB	192	ST20/3	236
RDR302	222	SF42/2	175	SRB24UB	192	ST20/4	236
RDR304	222	SF4A32	174	SRB29UB	192	ST3/2F	236
RDR306	222	SF4B32	174	SRB34UB	192	ST4/2	236
RF13	200	SF4T30	174	SRB40UB	192	ST4/2F	236
RF19	200	SF4T31	174	SRB45UB	192	ST4R	236
RF29	200	SGT002	223	SRB50UB	192	ST4W	236
RF35	200	SGT004	223	SRB55UB	192	ST51/13	25, 266
RF41	200	SGT006	223	SRB60UB	192	ST51/18	25
RF64	200	SGT012	223	SRB7UB	192	ST52/13	25, 266
RM13	200	SGT014	223	SRF380	237	ST52/18	25
RM19	200	SGT102	223	SRF384	237	ST52/24	25
RM29	200	SH1/11	34	SRF386	237	ST53/13	25, 266
RM35	200	SH1/22	34	SRS001	223	ST53/18	25
RM41	200	SH1/23	34	SRS002	223	ST53/24	25
RM64	200	SH1/33	34	SSD102	243	ST54/13	25, 266
RO13	200	SH1/44	34	SSD102K	243	ST54/18	25
RO19	200	SH15/19	33	SSD103	243	ST54/24	25
RO29	200	SH15/24	33	SSD103K	243	ST54/28	25
RO35	200	SH15/29	33	SSD104	243	ST55/28	25
RO41	200	SH16/19	33	SSD104K	243	ST6/7	234
RO64	200	SH16/24	33	SSD502	242	ST7/2	234
		SH16/29	33				

WGW237P.....	72
WGW238P.....	72
WGW239P.....	72
WGW443P.....	72
WGW444P.....	72
WGW445P.....	72
WGW446P.....	72
WGW447P.....	72
WGW530PML.....	70
WGW531PML.....	70
WGW531VTML.....	69
WGW532PML.....	70
WGW532VTML.....	69
WGW533PML.....	70
WGW533VTML.....	69
WGW534PML.....	70
WGW534VTML.....	69
WGW535PML.....	70
WGW535VTML.....	69
WGW536PML.....	70
WGW537PML.....	70
WGW537VTML.....	69
WGW538PML.....	70
WGW538VTML.....	69
WGW539PML.....	70
WGW539VTML.....	69
WGW540PML.....	70
WGW540VTML.....	69
WGW541PML.....	70
WGW541VTML.....	69
WGW600PML.....	70
WGW601PML.....	70
WGW602PML.....	70
WGW603PML.....	70
WGWPEN01.....	70, 71
WRP001P.....	219
WRP002P.....	219
WTR250P.....	72
WTR250VT.....	72
WTR500P.....	72
WTR500VT.....	72

X

X/34000695.....	258
XA10.....	25
XA21.....	25
XA31.....	25
XA32.....	25
XA41.....	25
XA42.....	25
XA43.....	25
XA52.....	25
XA53.....	25
XA54.....	25
XA64.....	25
XA74.....	25
XA85.....	25

Ordering information and customer support

Ordering SciLabware products

All of the products in this catalogue are available through an extensive worldwide network of laboratory supply dealers. If you have difficulty locating a supplier please visit our website www.scilabware.com or email our Customer Service team for assistance on info@scilabware.com.

Product information

All dimensions, capacities and weights are approximate unless otherwise stated. Please note that specifications may change during the life of this catalogue. Similarly products may be discontinued and new products introduced without prior notice. For current information on products please visit www.scilabware.com.

Technical support

Additional product information and application guidance is available from SciLabware's glass and polymer technologists.

For technical information regarding glass products please email: glass@scilabware.com.

For technical information regarding plastic products please email azlon@scilabware.com.

Pack quantities

The pack quantities shown in this catalogue are applicable to SciLabware's network of laboratory supply dealers. Whilst Dealers will prefer their customers to order in multiples of the pack quantity, to save repackaging costs, some Dealers are prepared to split packs for customers with modest requirements. Please contact your selected Dealer directly for advice.

Enquiries for custom-made glassware

SciLabware welcomes enquiries for glassware manufactured to your specific requirements. For details of this service and a free quotation please contact our Custom Glassware team by emailing customglass@scilabware.com

Enquiries for custom printed plastic bottles

SciLabware welcomes enquiries for plastic bottles printed to your specific requirements. For details of this service and a free quotation please contact our Custom Printing team by emailing customprint@scilabware.com

Trademarks

Quickfit®, MBL®, SVL®, Rotulex® and Lipsol® are registered trademarks of SciLabware Limited.

Pyrex® and Rotaflo® are registered trademarks of Corning Inc. SciLabware is a registered user.

© Copyright 2012

All material in this catalogue is protected by copyright. Reproduction, publishing or storage of any text, photograph or illustration is prohibited unless authorised by SciLabware Limited.

1. DEFINITIONS

In these conditions of Sale 'the Company' means SciLabware Limited 'the Buyer' means any company, firm, or individual from whom the Company receives an order which the Company has accepted in writing; 'the Goods' means the product, materials, equipment and/or services to be supplied by the Company; 'Specification' means the technical description (if any) of the Goods contained or referred to in the order.

2. APPLICABILITY OF CONDITIONS

The Company accepts orders for the supply of Goods subject only to these conditions. No variation of these conditions shall be valid or binding on the Company and these conditions shall override any inconsistent terms or conditions contained or referred to in any order, or correspondence of the Buyer or elsewhere unless such variation is made and accepted in writing by the Company.

3. PRICES

Unless fixed prices have been specifically agreed in writing by the Company notwithstanding any offer, quotation, tender price or price list, all prices are subject to alteration without notice and Goods will be invoiced at prices and, where applicable, exchange rates ruling at time of despatch. Unless otherwise agreed in writing all prices are strictly net of delivery charges, VAT and any other tax or duty which shall be added to the price payable by the Buyer.

4. TERMS OF PAYMENT

Accounts are payable strictly as specified on the Company's invoice. Usually this will be 30 days end of month, that is payment required the end of the month following invoice date. Where agreed credit limits have been exceeded, the company may request payment of current invoices before releasing further shipments. Without prejudice to the Company's rights, such payment shall be a condition precedent to any further deliveries. The Company reserves the right to charge interest on late payment of 2% per month above the base rate quoted by HSBC from time to time from the due date until full payment is received. Unless otherwise agreed in writing, the contract price shall be paid in Pound sterling. The Company may request for overseas orders, payment by letter of credit established in favour of the Company at the time of placing of the order by the Buyer. This must be advised via a first class British Clearing Bank acceptable to the Company and maintained valid for cash drawings against presentation of the Company's invoice(s)

until final contract payment but in any case for at least 3 months after scheduled completion of the contract taking into account any agreed extensions. The acceptance by the Company of the Buyer's order is conditional upon such letter of credit being received with the order. The Buyer agrees to arrange extension of such letter of credit for such period as may be requested by the Company from time to time. Other payment terms may be requested from time to time, depending upon individual orders, customer risk or country risk and will be discussed and agreed between the Company and the Buyer before despatch.

No claim by the Buyer under warranty or otherwise shall entitle the Buyer to any deduction, retention or withholding of any part of any sums due for payment hereunder. The Buyer shall not be entitled to any set off or obligations within or between contracts with the Company. All consular and bank charges and import and customs duties and taxes arising from or by virtue of the contract must be paid by the Buyer.

5. TIME FOR DELIVERY

Dates quoted for delivery are estimated only and not conditions of sale. No claim shall be made by the Buyer nor shall the Buyer refuse to accept delivery on the grounds of any failure to deliver on any particular date or dates.

6. DELIVERY

Delivery shall be deemed to be effective when the Goods are unloaded at the delivery address nominated by the Buyer or his agent for delivery, save where the Goods are to be collected by the Buyer or his Agent, when the Goods are loaded onto the vehicle collecting them. The Company reserves the right to deliver goods by instalments and in such event each instalment shall be treated as a separate contract provided that deliveries of further instalments may be withheld until the Goods or materials comprised in earlier instalments have been paid for in full.

7. QUANTITY ORDERED AND DELIVERED

Goods can only be supplied in the 'standard pack or quantity' or 'minimum buying quantity' shown in the Company price lists or in multiples thereof. The Company will use all reasonable endeavours to produce and deliver the quantity of Goods ordered but every contract and delivery is subject to the margins of tolerances (whether over or under the quantity stipulated) customary in the trade and no guarantee or warranty is given or implied on the part of the Company which is incompatible with this provision.

8. C & F AND CIF TERMS

CFR and CIF prices where appropriate will be based on the current rates of freight and insurance. Should any fluctuations in freight and insurance rates occur before completion of a contract the Company reserves the right to amend such prices effective from the date of such changes in rates. CFR prices will include cost and freight by direct routes to principle ports, airports or railheads in a Buyer's territory relevant to the means of transport and at the Company's discretion. CIF prices will, in addition to CFR terms, include insurance for breakage and/or loss on the basis of CIF value plus 10%. Any additional insurance will be for the Buyer's account. Cover notes will be issued for claims payable at destination and carrying an excess clause. It will be the Buyer's responsibility to present the claim in accordance with the provisions of these conditions.

9. PACKAGING

Prices shown in quotations or contracts will include the cost of the Company's normal packaging for destinations in the UK or for export unless stated otherwise. Any other forms of packaging supplied at customer's request will be charged extra and will be non-returnable.

10. NON-ACCEPTANCE OF DELIVERY

If the Buyer refuses or fails to take or accept delivery of the Goods at the time specified, the contract price shall nevertheless be paid as if delivery has taken place. The Company shall be entitled at its option to terminate the contract with immediate effect to dispose of the Goods as the Company may determine and to recover from the Buyer any loss and additional costs incurred as a result of such refusal or failure or to charge the Buyer for storage and other loss and expense reasonably incurred or suffered by the Company as a result of such refusal or failure but the Company shall not be bound to take any steps for the custody and care of such Goods or shall not be liable for any loss or damage suffered by the Buyer arising therefrom.

11. PASSING OF TITLE

(a) The absolute legal and beneficial ownership in all Goods shall remain vested in the Company and shall not pass to the Buyer until the purchase price of the order of which they form part (each order being considered as a whole) and all other monies owing by the Buyer to the Company on any account shall have been paid in full by the Buyer to the Company.

(b) Until such payment has been made, the Buyer shall hold the Goods sold as bailee of the Company and in a fiduciary capacity and shall not sell, dispose of, process or use the Goods except with the express written permission of the Company and on condition that if authorised to resell the Goods to a

third party, the Buyer shall not mingle any proceeds of sale with any other monies and shall at all times keep them in a separate bank account and identifiable as the Company's monies and shall forthwith account to the Company for the proceeds of sale to the extent of the Buyer's indebtedness to the Company.

(c) Pending receipt of payment made in accordance with these conditions the Goods shall be set aside and stored separately from other Goods in the possession of the Buyer so as to be clearly and separately identifiable and the Buyer shall deliver them upto the Company at any time on demand.

(d) In the event that the Buyer shall breach any of its obligations under these conditions or under any other agreement between the parties, the Company reserves the immediate right to repossess all or any of the Goods to which it has retained title aforesaid and thereafter to resell the same and for this purpose the Buyer hereby grants an irrevocable right of licence to the Company's servants and agents to enter upon all or any of its premises with or without vehicles during business hours. This right shall continue to subsist notwithstanding the termination of the contract for any reason and is without prejudice to any accrued rights of the Company hereunder or otherwise.

12. PASSING THE RISK

The risk in the Goods shall pass to the Buyer upon delivery. The Buyer shall insure the Goods with a reputable insurance company and if the same are damaged or destroyed, then such insurance monies as are payable shall be immediately paid by the Buyer to the Company to the extent of the indebtedness of the Buyer to the Company and without prejudice to any right of the Company to recover from the Buyer any balance of the purchase price remaining due under the contract.

13. CLAIMS

In the event of any loss or damage or delay to any Goods delivered at our risk to the Buyer or to his agent or otherwise to his order notice of the same shall be given to us in writing by the Buyer forthwith upon delivery (or, in the case of loss of any Goods, at the time when the Goods should have been delivered) and the Buyer shall at the same time take all necessary steps to notify the carrier in writing of any such loss damage or delay and where practicable shall enter a note of the same upon the carriers receipt. If by reason of the failure of the Buyer to give any such notice as provided above, the Company is precluded from making a recovery from the carrier in respect of the loss damage or delay complained of then the Company shall not be liable for any claim by the Buyer in respect thereof and the Buyer shall be liable to pay for the Goods as though no such loss damage or delay had occurred.

14. WARRANTY

The Company warrants that the Goods shall be in conformity with the Specification or be within its usual tolerances as to quality and finish. The Company shall replace or at its option refund the purchase price as applicable to any Goods which do not in its sole opinion comply with this warranty, provided always that any claim under this warranty is made within 24 hours of commencement of the processing of the Goods or (if earlier) within 28 days of delivery of the Goods alleged to be defective.

It is the Buyer's responsibility to determine whether the Goods are suitable for the contemplated use, whether or not such use is known to the Company. No warranty, condition or representation is given or made as to the quality of the Goods supplied hereunder their condition or their fitness for any particular purpose and any such warranty, condition or representation whether express or implied whether by statute, by collateral agreement or otherwise is hereby excluded.

15. LIMITATION OF LIABILITY

Except for death or personal injury caused by the negligence of the Company, the Company's aggregate liability to the Buyer howsoever arising whether for negligence, breach of contract, misrepresentation or otherwise shall under no circumstances exceed the cost of the defective, damaged or undelivered Goods which give rise to such liability as determined by the net price invoiced to the Buyer in respect of any occurrence or series of occurrences.

16. CANCELLATION BY THE BUYER

The Buyer may cancel or suspend the contract only with the Company's prior written consent following agreement by the Buyer to reimburse the Company in an amount to be determined by the Company or the Buyer may, not later than 3 days before the scheduled delivery date, by written notice, cancel the order for Goods provided that the Buyer shall reimburse the Company for any costs incurred up to the date of receipt of the notice of such cancellation.

17. TERMINATION BY THE COMPANY

The Company shall (without prejudice to any of its other rights hereunder) be entitled to terminate any contract forthwith by written notice to the Buyer if the Buyer shall:

- Become insolvent
- Fail to pay any amounts falling due (whether under these conditions or otherwise) to the Company within 30 days of the date payment is due.
- Have a Receiver appointed
- Pass a resolution for winding-up (other than for purposes of reconstruction or amalgamation)
- Commit a breach of any term of the contract or any other contract with the Company.

18. FORCE MAJEURE

If the commencement, continuation or complete performance by the Company of its obligations under this contract is prevented, hindered, delayed or rendered uneconomic by reason of force majeure then the Company shall not be responsible to the Buyer for any loss or damage incurred or sustained by the Buyer as a result. For the purpose of this condition, the term Force Majeure shall include any factor affecting the performance of this contract attributable to acts, events, non-happenings, omissions or incidents beyond the reasonable control of the Company and, in particular, (but without limiting the generality of the foregoing), the following, namely: strikes, lock-outs, riots, civil revolution, war, state of national emergency of governmental action, trade dispute or labour disturbance, accident, break down of plant or machinery, difficulty or increased expense in obtaining workmen, materials or transport, fire, explosion, storm, flood, earthquake or other natural physical disaster or circumstances affecting the supply of the Goods (or the raw materials therefore) by a Company's normal source of supply or the delivery of the Goods by the Company's normal route or means of delivery.

19. IMPORT LICENCES

The Buyer's order must specify the number, date of expiry and value of any necessary Import Licence.

20. NOTICES

Any notice hereunder shall be deemed to have been given if sent by pre-paid, first class post, fax or email to the party concerned at its last known address. Notices sent by first-class post shall be deemed to have been given 7 days after dispatch and notices sent by fax or email shall be deemed to have been given on the date of dispatch.

21. CONSTRUCTION

All contracts made with the Company shall be governed by and construed according to the laws of England and the parties hereby submit to the jurisdiction of the English courts.

March 2012



SciLabware

AZLON® MBL® PYREX® QUICKFIT®

I.C.T, S.L. - INSTRUMENTACION CIENTIFICA TÉCNICA, S.L.

Avda. de Juan Carlos I, 24 · 26140 Lardero (La Rioja) · España

Tel: (+34) 902 193 170 · Fax: (+34) 902 193 167

Http://www.ictsl.net · E-mail: información@ictsl.net