

**Shandon  
Cytospin® 4  
Cytocentrifuge**



**Thin-layer  
Cell Preparation  
System**

# Shandon Cytospin® 4 Cyto centrifuge

The ultimate thin-layer cell preparation system.

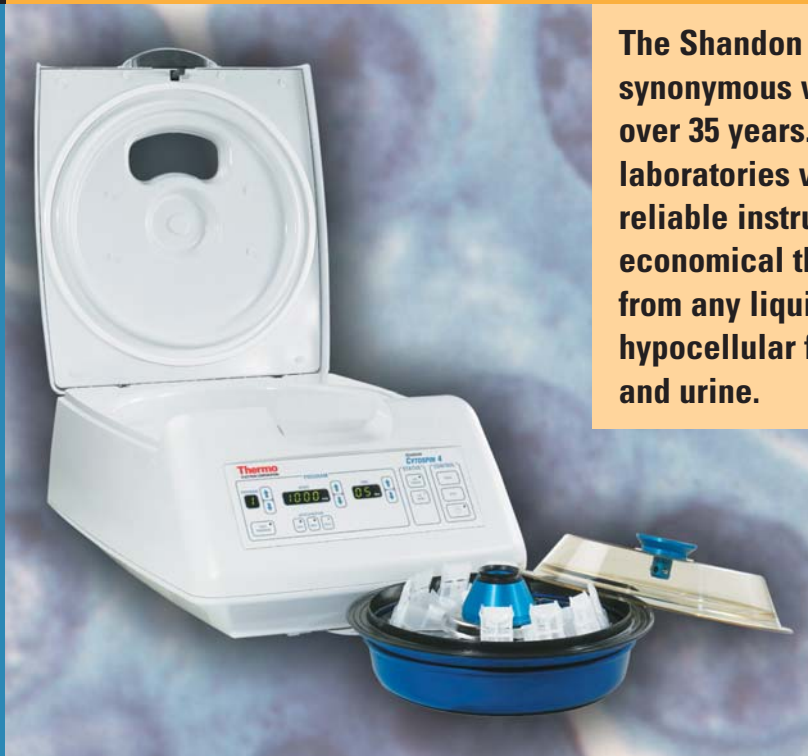

The Shandon Cytospin has been synonymous with cyto centrifugation for over 35 years. More than 15,000 laboratories worldwide use this simple, reliable instrument. It provides economical thin-layer preparations from any liquid matrix, especially hypocellular fluids such as spinal fluid and urine.

The Shandon Cytospin was the first device to use carefully controlled centrifugation to separate and deposit a thin layer of cells on slides while maintaining cellular integrity. It produces better cell capture and good representation of all cell types present in homogeneous liquid samples.

## Features

- Process **12 specimens** at one time.
- Accepts all protocols from **Shandon Cytospin 1, 2, and 3**.
- **Redesigned Lid-release Mechanism** allows for **one-handed opening and closing** of the outer lid for easy access. As an added safety measure, the Shandon Cytospin will only operate when the lid is locked into position. The lid remains **locked at all times** during rotation. The polycarbonate window allows the operator to see the Sealed Head during cyto centrifugation.
- **Excellent safety design prevents accidental fluid spillage** from damaging the mechanical or electronic components and allows for easy disinfecting. It meets stringent IEC 61010 standards for centrifuge safety.
- **Pull-out Program Card** allows for up to **nine programs** to be logged for fast and convenient retrieval (erasable ink pen included).

## Safe and Reliable

The Shandon Cytospin is designed to protect the operator before, during and after sample preparation. Safety is our top priority. The ability to load the Shandon Cytospin Sealed Head in a microbiological cabinet is the ultimate safety procedure.

- Auto-locking, plastic outer lid
- Autoclavable Sealed Head
- Disposable sample chambers with caps
- Safety alarms that protect users and specimens
- Wipe-clean control panel

## Simple Principle for Excellent Presentation

Using centrifugal principles, the Shandon Cytospin deposits cells onto a clearly-defined area of a glass slide and allows for the absorption of the residual fluid into the sample chamber's filter card (except Shandon EZ Megafunnel). Cyto centrifugation also constructively flattens cells for excellent nuclear presentation. During operation, the instrument's spinning action tilts the Shandon Cytofunnels® upright and centrifuges cells onto the deposition area of the slide, giving all cell types equal opportunity for presentation. In the Load or Stop position, this unique tilting feature reduces cell loss by preventing residual fluid from coming into contact with the prepared slide.

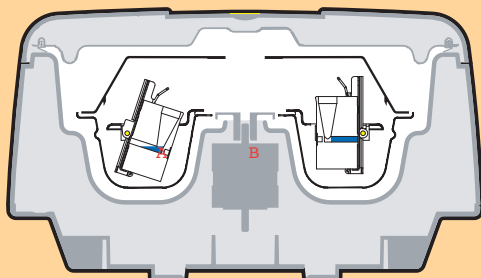

- A In Load Position (Stopped)
- B In Operation (Spin)

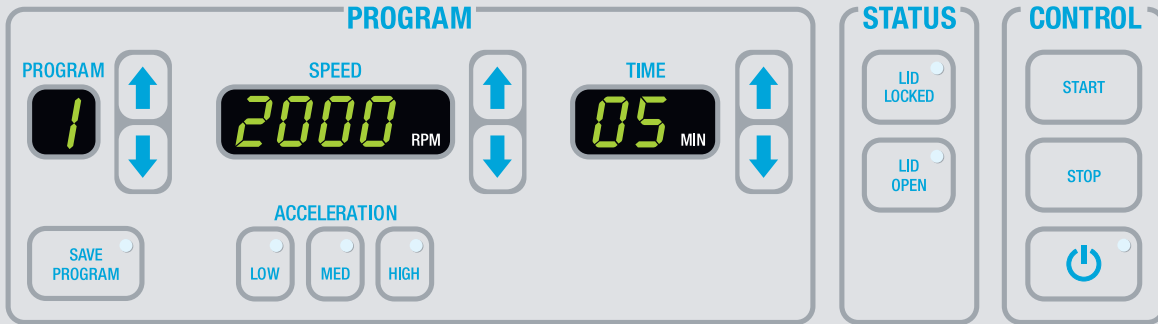

### Simple and Precise Controls

- **Protected Program Memory** stores up to 23 routines for instant recall and protects from power loss.
- **Program Key Pad** has “easy-touch” design that allows for easier keystrokes and more intuitive programming.
- **Speed** window displays the programmed spinning speeds from 200 – 2000 rpm.
- **Three Acceleration Control** buttons allow the operator excellent flexibility and exceptional protection for fragile samples.
- **Time** window displays the programmed and remaining run time from 1– 99 minutes.
- **Control** feature has a standby power saving mode. Displays are also turned on and off by the standby key.
- **Specimen safety alarm** feature has been added to remind users at one-minute intervals to remove specimens, protect them from “air-drying” and ensure consistent results.

- **Safety Alarms** include an **audible alarm** that signals the operator if the Shandon Cytospin is out of balance, outside the speed tolerance, or if the lid is not properly locked. As an extra measure of safety for the user, the unit will not spin if the lid is not locked.

### Shandon Cytospin® 4 Specifications

Description	Order Number
<b>Shandon Cytospin 4 Cytocentrifuge (Unit Only)</b>	A78300002
<b>Shandon EZ Funnel Starter Kit</b>	A78710013
Includes 25 Shandon EZ Megafunnels™, 20 Shandon EZ Single White Cytofunnels®, 20 EZ Double Cytofunnels, and Shandon Cytoslides®	
<b>Shandon Clipped Funnel Starter Kit</b>	3120110
Includes 25 Shandon EZ Megafunnels™, 50 Shandon Single White Cytofunnels®, 25 Double Cytofunnels, Shandon Cytoslides®, and 12 Shandon Cytoclips®	
Physical Specifications	
Dimensions (H x W x D)	
With Closed Lid:	9.5" x 16" x 24.5" (24 x 40.5 x 62 cm)
With Opened Lid:	25" x 16" x 24.5" (62.5 x 40.5 x 62 cm)
Weight	
26.5 lbs. (12 kg)	
Power Requirements	
100-240 VAC, 50/60 Hz, 1 Ph, 150 VA Max	

### Shandon Cytospin Sealed Head



- One Sealed Head is included with the Cytospin, but many laboratories shorten preparation time by having a second Sealed Head ready for when the first finishes processing.
- Autoclavable, 12-chamber Head seals completely.

Description	Pkg/Qty	Order Number
<b>Shandon Cytospin Sealed Head</b>	Each	59910018

Included with Product*	Pkg/Qty	Order Number
Sealed Head/Rotor	Each	59910018
Marking Pen	Each	AP14891
Operator Manual (specify language)	Each	A78310250
Service Record Book	Each	A78310252
Standard Workflow Diagram	Each	A783-1001

\* Contents, Packaging, and Quantities of items listed under “Included with Product” are subject to change without prior notice.

Additional Accessories	Pkg/Qty	Order Number
Service Manual	Each	A78310251
Sealed Head Seals	3 / Pk.	59910019
Shandon Cytofunnels		See pages 4-7
Glass Microscope Slides		See page 9.
Silver Service Plan (See Page 12)		A78300001C

### Agency Approvals

IEC 61010, CSA, UL, and CE Mark (IVDD compliant).

# Shandon EZ Cytofunnel® Sample Chambers

No more Clips!!

- Intended for single use with all Shandon Cytospin® Cytocentrifuge applications.
- Simple and easy to use operational illustrations are included in the package.
- Optimizes cell yield.
- Safe – reduces the risk of exposure to pathogenic samples.
- Disposable – eliminates time-consuming decontamination and cleaning.
- Decreases the possibility of cross-contamination.
- Eliminates the need for metal Shandon Cytoclips®.
- Closure caps provided with kit.
- Produces more cost-effective thin-layer preparations when compared to other thin-layer methods.



## Shandon EZ Cytofunnel Bench Stand



- Convenient for loading samples outside of the Shandon Cytospin® chamber.
- Stainless steel construction.
- Holds 12 Shandon EZ Cytofunnels.

Description	Pkg/Qty	Order Number
Shandon EZ Single Cytofunnel Bench Stand	Each	A78710022

## Shandon EZ Megafunnel™

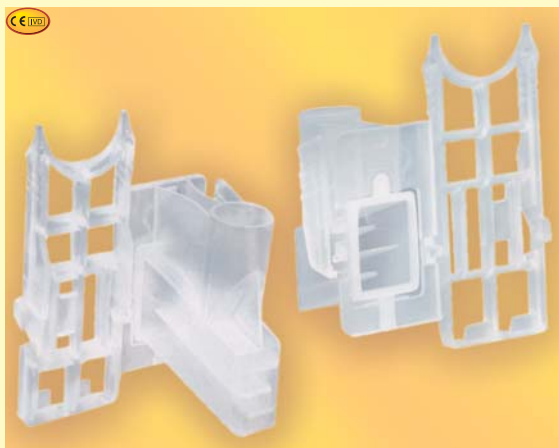

- Designed for convenient preparation of larger volume samples.
- Shandon Cytofunnels designed for spinning large samples up to 6 ml.
- Minimizes the need to pre-centrifuge.
- Cell deposition area of 22 x 14.75 mm (325 mm<sup>2</sup>) for increased cell yield.
- Shandon Megafunnel Cytoslides® included.
- Can prepare both air-dried and fixed preparations, providing additional valuable diagnostic information.

Description	Pkg/Qty	Order Number
Shandon EZ Megafunnel With Caps And Slides	25 / Box	A78710001



## Shandon EZ Single Cytofunnel® with White Filter Cards



- Disposable Sample Chambers with White Filter Cards.
- Use for sample volumes up to 0.5 ml.
- Cell deposition area of 6 mm in diameter (28 mm<sup>2</sup>).
- Pre-attached white filter card for high absorbency.

Description	Pkg/Qty	Order Number
<b>Shandon EZ Single Cytofunnel</b> With White Filter Cards and Caps	40 / Box	A78710003
<b>Shandon EZ Single Cytofunnel</b> With White Filter Cards and Caps	200 / Pk.	A78710020

## Shandon EZ Single Cytofunnel with Brown Filter Cards



- Disposable Sample Chambers with Brown Filter Cards.
- Use for sample volumes of 0.4 ml or less.
- Cell deposition area of 6 mm in diameter (28 mm<sup>2</sup>).
- Pre-attached brown filter card for slower absorbency.
- Excellent for scanty specimens such as CSF.

Description	Pkg/Qty	Order Number
<b>Shandon EZ Single Cytofunnel</b> With Brown Filter Cards and Caps	40 / Box	A78710004

## Shandon EZ Double Cytofunnel



- Disposable Sample Chambers.
- Allows 2 sample deposition areas on a single slide.
- Double the number of sample presentations per run.
- Funnel markings correspond to slide markings for simple identification.
- Pre-attached filter card.

Description	Pkg/Qty	Order Number
<b>Shandon EZ Double Cytofunnel</b> With White Filter Cards and Caps	40 / Box	A78710005
<b>Shandon EZ Double Cytofunnel</b> With White Filter Cards and Caps	200 / Pk.	A78710021

# Shandon Cytofunnel® Sample Chambers

The original is still the most trusted clipped funnel available today.

## Shandon Single Cytofunnel® with White Filter Cards



- Disposable Sample Chambers with White Filter Cards.
- Use for sample volumes up to 0.5 ml.
- Pre-attached filter card.

Description	Pkg/Qty	Order Number
<b>Shandon Single White Cytofunnels With Caps</b>	50 / Box	5991040
<b>Shandon Single White Cytofunnel Economy Pack With Caps</b>	500 / Case	1102548

## Shandon Single Cytofunnel with Brown Filter Cards



- Disposable Sample Chambers with Brown Filter Cards.
- Use for sample volumes of 0.4 ml or less.
- Pre-attached filter card.
- Excellent for scanty specimens such as CSF.
- Increases cell yield.

Description	Pkg/Qty	Order Number
<b>Shandon Single Brown Cytofunnels With Caps</b>	50/Box	5991043

## Shandon Double Cytofunnel



- Disposable Sample Chambers.
- Reduce preparation time.
- Funnel markings correspond to slide markings for simple identification.
- Pre-attached filter card.
- Ideal for use with immunochemistry techniques.

Description	Pkg/Qty	Order Number
<b>Shandon Double White Cytofunnel With Caps</b>	25 / Box	5991039
<b>Shandon Double White Cytofunnel Economy Pack With Caps</b>	500 / Cs.	1102547

## Shandon Cytoclip™



- Shandon Cytoclip holds Cytofunnel® disposable sample chamber against the microscope slide for preparation in the Shandon Cytospin® Cytocentrifuge.
- Eliminates contact between contaminated Shandon Cytofunnels and laboratory personnel.
- Clips are autoclavable and reusable.

Description	Pkg/Qty	Order Number
<b>Shandon Cytoclip</b> Stainless Steel Slide Clip	6 / Box	59910052

## TPX® Single Sample Chamber, Caps, and Filter Cards



### TPX Single Sample Chamber and Caps

- Reusable and autoclavable.
- Choice of using disposable white filter cards for sample volumes up to 0.5 ml or disposable brown filter cards for sample volumes of 0.4 ml or less.

### Filter Cards

- Highly absorbent disposable filter cards for use with TPX chamber.
- Not for use with Cytofunnel® disposable sample chambers.
- Use white filter cards for samples up to 0.5 ml.
- Use brown filter cards for samples of 0.4 ml or less.

Description	Pkg/Qty	Order Number
<b>TPX Sample Chamber</b>	12 / Pk.	A78710018
<b>Sample Chamber Closure Caps,</b> For Shandon TPX Chambers	12 / Pk.	59910025
<b>Brown Filter Cards</b>	200 / Box	5991023
<b>White Filter Cards</b>	200 / Box	5991022

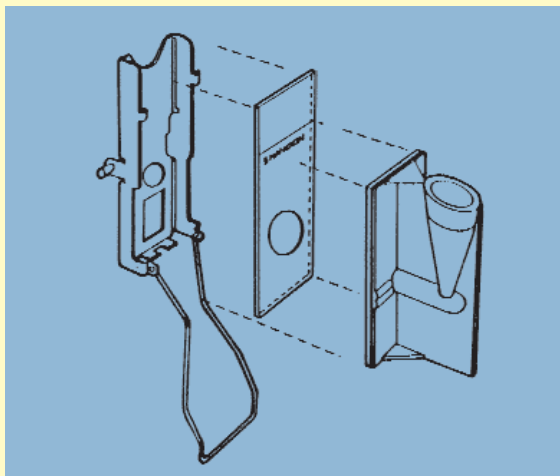

### How the Cytofunnel Works

The Cytofunnel fits snugly against a specially marked Cytoslide and is held in place by a Shandon Cytoclip. Twelve Shandon Cytoclip assemblies fit into the Cytospin head.

After cytocentrifugation, the Shandon Cytoclip easily unlocks to dispose of the sample chamber and to remove the slide.

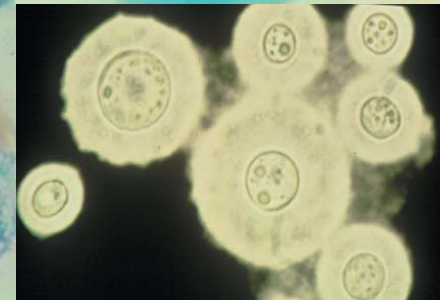
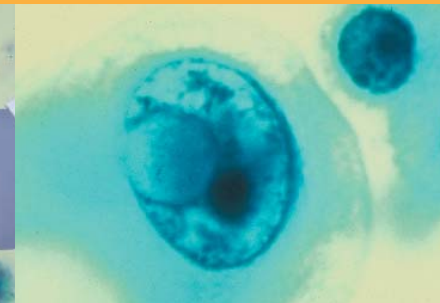

## Disciplines That Use the Cytospin®:

### Cytology

- Still the gold standard for Non-Gynecological Cytology, especially hypocellular fluids.
- Many types of collection fluids and funnel options to choose from.
- Quality presentation at a fraction of the cost of other "thin-layer" technologies.
- Prepares both "air-dried" and "fixed" specimens.

### Microbiology

- Micro-organisms are often present in low numbers from limited sample volumes. Cyto-centrifugation effectively spins the micro-organisms onto the slide, maximizing the yield and presenting those organisms in a clean, defined area, allowing for straightforward morphological identification.
- Only a small sample volume is needed so multiple samples may be run for a variety of special staining and support testing. It also concentrates samples for Gram stains.

### Hematology/Oncology

- Easy to achieve a constant cell/unit volume.
- Excellent for all fluids, bone marrow, and peripheral blood.
- Even with a cell count of "zero," the Cytospin often locates the few cells in the fluid that the counter missed.

### Virology

- There are many published technical papers utilizing the Cytospin for the rapid detection of respiratory viruses, CMV Detection, ISH, FISH, etc.

### Research/General Use

- The most cost-effective, time-effective way to make quality thin-layer cell presentations.
- Excellent for molecular studies, specialized staining applications, and EM.
- Used in veterinary, dental and chemosensitivity protocols.

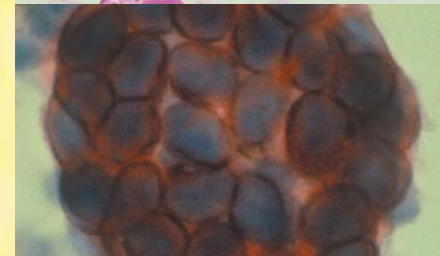
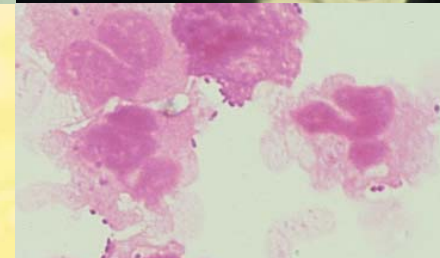



# Shandon Cytoslides®

- Specially marked Slides for the Shandon Cytospin®.
- Specimen area is outlined for rapid location during screening.
- All slides are 75 x 25 mm, made from high-quality optical glass.

## Coated Slides

- Eliminates the need for albumin coating procedures.
- Saves labor and resource time.
- Eliminates background staining on albuminized, IHC or ISH processed slides.

## Shandon Double Cytoslides

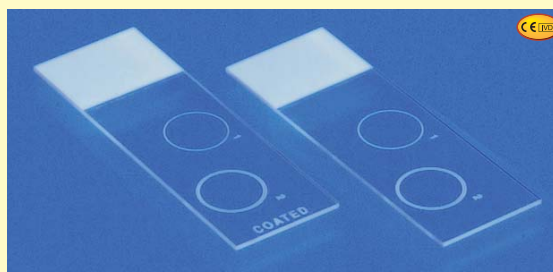

- Specially made for use with Shandon EZ Double Cytofunnel® Chambers.
- Each specimen is displayed onto the slide within a circle marked "1" or "2" which corresponds with the Shandon EZ Double Cytofunnel chamber.

Description	Pkg/Qty	Order Number
Shandon Cytoslides, Double Circle, coated	100/box	5991055
Shandon Cytoslides, Double Circle, non-coated	100/box	5991054

## Shandon Single Cytoslides



- Specially made for use with Shandon EZ Single Cytofunnels.
- A white, 12 mm diameter circle on the slide defines the area where cells will be displayed to allow for efficient and rapid location.
- Uncoated slides available with circle on front or back.

Description	Pkg/Qty	Order Number
Shandon Cytoslides, Single Circle coated with circle on back	100/box	5991056
Shandon Cytoslides, Single Circle non-coated with circle on back	100/box	5991051
Shandon Cytoslides, Single Circle non-coated with circle on front	100/box	5991059

## Shandon Mask Cytoslides

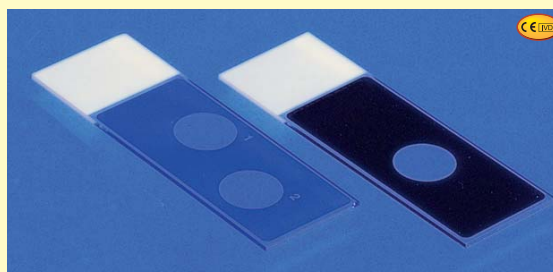

- Specially produced for immunofluorescence.
- Black-coating masks out UV light so that only the specimen within the circle can be viewed through a microscope.

Description	Pkg/Qty	Order Number
Shandon Cytoslides, Single Circle, Black mask	100/box	5991057
Shandon Cytoslides, Double Circle, Blue mask	100/box	85991050

# Shandon Cytology Collection Fluids

## Shandon Cytospin® Collection Fluid



- Ready-to-use alcohol/CARBOWAX® (PEG) combination for direct specimen collection and fixation.
- Permits storage of specimens or unstained slides for weeks without adverse effect.
- Packaged in several forms, including convenient pump bottle and pre-filled specimen cups.

Description	Pkg/Qty	Order Number
<b>Shandon Cytospin Collection Fluid</b>	3.8 L x 1 (with pump)	6768001
<b>Shandon Cytospin Collection Fluid</b>	500 ml x 2	6768315
<b>Shandon Cytospin Collection Fluid</b>	10 L x 2	9990310
<b>Shandon Cytospin Collection Fluid</b>	120 ml Cups, filled to 60 ml, 125 / Cs.	9990323

## Shandon Cell-Fixx™ Spray Fixative



- Spray fixative for convenient preparation of slides.
- Includes CARBOWAX which coats the smear to maintain cellular detail.
- Prevents air-drying artifact and cell loss.

Description	Pkg/Qty	Order Number
<b>Shandon Cell-Fixx</b>	50 ml Pump Spray Bottle x 6	6768326

## CytoRich® Red Collection Fluid (Concentrated Formula)



- Ready-to-use alcohol-based fluid.
- Lyses RBC's and solubilizes proteins.
- Compatible with immunohistochemistry.
- Pre-filled containers available.

Description	Pkg/Qty	Order Number
<b>CytoRich Red Collection Fluid</b>	3.8 L x 1	B9990800
<b>CytoRich Red Collection Fluid</b>	500 ml x 2	B9990801
<b>CytoRich Red Collection Fluid</b>	20 ml Cups, filled to 10 ml, 180 / Cs.	B9990802
<b>CytoRich Red Collection Fluid</b>	120 ml Cups, filled to 60 ml, 125 / Cs.	B9990803

## Shandon Mucolexx™



- Ready-to-use mucoliquifying preservative.
- Liquefies (with agitation) mucoid cytology specimens.
- Maintains cellular detail.
- Short term preservation of specimens.

Description	Pkg/Qty	Order Number
<b>Shandon Mucolexx</b>	3.8 L x 1	9990371
<b>Shandon Mucolexx</b>	500 ml x 4	9990370
<b>Shandon Mucolexx</b>	120 ml Cups, filled to 60 ml, 50 / Cs.	9990375

# Shandon Cytology Stains

Biological Stain Commission Certified Dyes.

## Shandon EA-50

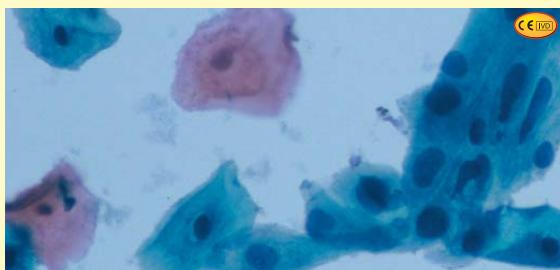

- Polychromatic cytoplasmic stain.
- Clearly differentiates cellular components with pink, green, and blue-green hues.

Description	Pkg/Qty	Order Number
<b>Shandon EA-50</b>	4 L x 1	6766002
<b>Shandon EA-50</b>	1 L x 2	6766001

## Shandon OG-6

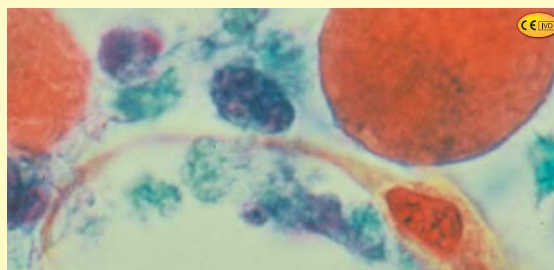

- Demonstrates keratin in cytoplasm.

Description	Pkg/Qty	Order Number
<b>Shandon OG-6</b>	4 L x 1	6766006
<b>Shandon OG-6</b>	1 L x 2	6766005

## Shandon EA-65

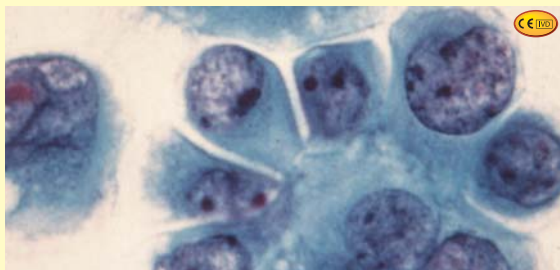

- Polychromatic cytoplasmic stain.
- Lower concentration of Light Green improves expression of eosin-stained components.
- Ideal for thicker non-GYN preparations.

Description	Pkg/Qty	Order Number
<b>Shandon EA-65</b>	4 L x 1	6766004
<b>Shandon EA-65</b>	1 L x 2	6766003

## Shandon Kwik-Diff™ Stains

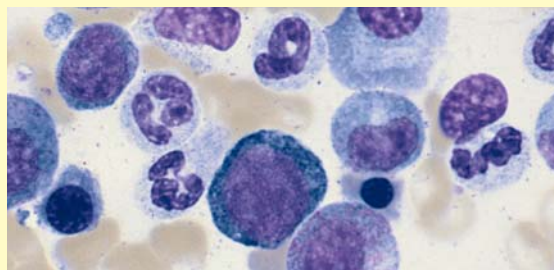

- Fast 3-step differential stain for cytologic preparations, FNA's and microorganisms such as Helicobacter pylori.
- A quick alternative to traditional Wright's and Giemsa Staining procedures.
- Kit Components:

Reagent 1: Fixative

Reagent 2: Eosin

Reagent 3: Methylene Blue

- Available in kit form or as individual components.

Description	Pkg/Qty	Order Number
<b>Shandon Kwik-Diff Stain Kit</b>	500 ml Reagent Size	9990700
<b>Shandon Kwik-Diff Stain Kit</b>	125 ml Reagent Size	9990701
<b>Shandon Kwik-Diff Reagent 1</b>	4 L x 1	9990705
Fixative		
<b>Shandon Kwik-Diff Reagent 2</b>	4 L x 1	9990706
Eosin		
<b>Shandon Kwik-Diff Reagent 3</b>	4 L x 1	9990707
Methylene Blue		

## Shandon Cytology Spatula



- Economical.
- Designed with classic Ayre end and tapered tip.
- Made from smooth, select wood for good cell retention and release.

Description	Pkg/Qty	Order Number
<b>Shandon Cytology Spatula</b>	1000 (40 Bags x 25)	9990330

# Technical Services

Rest easy with Thermo Electron Service.

## Shandon Cytoblock® Cell Block Preparation System



- Facilitates processing of FNA's, tissue fragments and cell buttons quickly and reliably.
- Increases ability to process scanty or unseen material for cell block and reduces loss of critical material.
- Suitable for immunohistochemical techniques.
- Replaces time-consuming and costly agar and thrombin techniques.
- Requires phosphate-free fixative on processor, such as Zinc Formal-Fix™, Formal-Fix™, or Glyo-Fix™ (formalin substitute) or simply bypass formalin fixation steps on processor. Cytoblock can also be run on a rapid biopsy program.

Description	Pkg/Qty	Order Number
<b>Octospot Starter Pack</b>	Each	1001622
<b>Cytoblock Cell Block Preparation System</b>	1 kit / 50 specimens	7401150
<b>Replacement Reagents</b>	11ml / Each	7401151

## Shandon Octospot™\*



- Cytoцентрифуге cells from 8-well microtiter strips directly onto a microscope slide (96 spots per spin). Turn 8 slides into 1.
- Incorporates an 8-well strip, an 8-well slide, a holding block and filter card assembled in a standard Cytoclip.
- Solvent-resistant slides retain separate reagents in individual wells to prevent cross-contamination.

Description		Pkg/Qty	Order Number
<b>Octospot Starter Pack</b>		Each	1001622
with Easy Write Slides			
<b>Octospot Starter Pack</b>		Each	1001623
with Solvent Resistant Slides			
<b>Filter Cards</b>	Thick	100 / Pk	1001641
(for protein free samples of 30-40 microliters)			
<b>Filter Cards</b>	Thin	200 / Pk	1001649
(for 15-20 microliter samples)			
<b>8-well Strips</b>		12 strips/rack x 5	1001643
<b>8-well Strips</b>	Loose	60 / Bag	1001642
<b>Solvent-Resistant Slides</b>	8 spots	100 / Box	1001645
<b>EZ-Write Slides</b>	8 spots	100 / Box	1001646
<b>Coverglass</b>		1oz. Pk x 10 / Cs.	1001624
22 x 70 mm, 1.0 thickness			
<b>Holding Block</b>		Each	1001644
<b>Slide Rack Lids</b>		50 / Pk	1001647

\*Octospot is a trademark of Bath Analytical

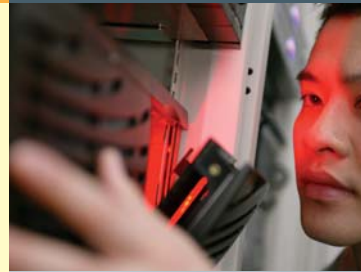

**Downtime equals wasted time.**

With today's busy laboratory environments, where resources are constrained, workloads continue to increase, funds are limited, and productivity is the key to success, having to deal with an instrument that is not working as hard as you are – or not at all – is simply not acceptable.

At Thermo Electron Anatomical Pathology, we understand how important it is to keep your lab up and running. No matter what your service requirements are, Thermo AP has a solution that can help keep you working at peak efficiency.

- Flexible programs based on your workflow and particular laboratory needs.
- Only original factory parts are used for repair and maintenance.
- Our factory-trained technicians are conveniently located throughout the country and have years of experience servicing Thermo AP equipment.
- 24/7/365 phone support (U.S. only).
- Technical hotline service available.

**Our Gold Plan\*** provides maximum coverage and priority response. It covers all costs including labor, travel time, expenses, and parts. An annual preventative maintenance inspection is performed by a factory certified service engineer to provide continued optimal performance of your Thermo instrument.

**Our Silver Plan\*** offers the same coverage as our standard manufacturer's warranty. All repair costs are included and pre-budgeted so you do not experience the surprise of unplanned expenses.

**Our Bronze Plan\*** is a prevention plan. Once a year, one of our factory certified service engineers will perform preventative maintenance inspection on your instrument to ensure that your instrument is working properly and meeting factory standard specifications. Service includes instrument lubrication, cleaning, calibration, and performance checks, as applicable.

\* Service Plan Coverage varies in different countries.

**Thermo**  
ELECTRON CORPORATION

Anatomical Pathology USA  
Tel: 1-800-547-7429 1-412-788-1133  
Fax: 1-412-788-1138

Anatomical Pathology International  
Tel: 0800 0189396 +44 (0) 1928 562501  
Fax: +44 (0) 1928 562627

I.C.T., S.L. - Thermo A.P.Dpt.  
Avda. de Juan Carlos I, 24  
ES26140 Lardero (La Rioja) - Spain  
Tel: +34 902 193 170  
Fax: +34 902 193 167  
Web: www.ictsl.net